

Project	<b>IEEE 802.16 Broadband Wireless Access Working Group</b> < <a href="http://ieee802.org/16">http://ieee802.org/16</a> >	
Title	Dedicated Resource Assignment for RS	
Date Submitted	<b>2007-03-15</b>	
Source(s)	<p>Derek Yu, Hang Zhang, Peiying Zhu, Wen Tong, David Steer, Gamini Senarath, Mark Naden, G.Q. Wang</p> <p>Nortel 3500 Carling Avenue Ottawa, Ontario K2H 8E9</p> <p>Byung-Jae Kwak, Dong-Seung Kwon Sungcheol Chang, Dong-Hyun Ahn ETRI 161 Gajeong-dong Yuseong-gu Daejeon, 305-700, Korea</p> <p>Nah-Oak Song, Whan-Sun Kim MMPC, KAIST 373-1 Gajeong-dong, Yuseong-gu, Daejeon, 305-701, Korea</p> <p>Changkyoon Kim, Kyu Ha Lee, Hyung Kee Kim Samsung Thales San 14, Nongseo-dong, Giheung-gu Yongin, Gyeonggi-do, Korea 449-712</p> <p>Wei-Peng Chen, Chenxi Zhu, Jonathan Agre, Fujitsu Laboratories of America 1240 E. Arques Avenue, M/S 345, Sunnyvale, CA 95051, USA</p> <p>Aik Chindapol, Jimmy Chui, Hui Zeng Siemens Corporate Research 755 College Road East, Princeton, NJ, USA</p> <p>Koon Hoo Teo Mitsubishi Electric Research Lab 201 Broadway, Cambridge, MA 02421</p> <p>Kanchei (Ken) Loa, Yi-Hsueh Tsai, Shiann-Tsong Sheu, Hua-Chiang Yin, Yung-Ting Lee, Chih-Chiang Hsieh, Frank C.D. Tsai, Youn-Tai Lee, Heng-Iang Hsu Institute for Information Industry 8F., No. 218, Sec. 2, Dunhua S. Rd., Taipei City, Taiwan</p> <p>Shulan Feng, Yanling Lu, Ting Li, Liangliang Zhang Hisilicon Technologies</p>	<p>Voice: +1 613 763-1315 <a href="mailto:wentong@nortel.com">[mailto:wentong@nortel.com]</a> <a href="mailto:pyzhu@nortel.com">[mailto:pyzhu@nortel.com]</a></p> <p>Voice: +82-42-860-6618 Fax: +82-42-861-1966 <a href="mailto:bjkwak@etri.re.kr">mailto:bjkwak@etri.re.kr</a></p> <p>Voice: +82-42-869-8886 <a href="mailto:nsong@mmpc.kaist.ac.kr">[nsong@mmpc.kaist.ac.kr]</a></p> <p>Voice: +82-31-280-9917 Fax: +82-31-280-1562 <a href="mailto:kyuha.lee@samsung.com">kyuha.lee@samsung.com</a></p> <p>Voice: +1 408-530-4622 <a href="mailto:wei-peng.chen@us.fujitsu.com">wei-peng.chen@us.fujitsu.com</a> <a href="mailto:chenxi.zhu@us.fujitsu.com">chenxi.zhu@us.fujitsu.com</a> <a href="mailto:jonathan.agre@us.fujitsu.com">jonathan.agre@us.fujitsu.com</a></p> <p>Voice: +1 609 734 3364 Fax: +1 609 734 6565 <a href="mailto:aik.chindapol@siemens.com">aik.chindapol@siemens.com</a></p> <p>Voice +1 617 621 7527 <a href="mailto:teo@merlcom">teo@merlcom</a></p> <p>Voice: +886-2-2739-9616 <a href="mailto:loa@iii.org.tw">loa@iii.org.tw</a></p> <p>Voice: 86-10-82829010 Fax: 86-10-82829075</p>

2007-03-15

Harbour Building, No.8, Dongbeiwang West Road,  
HaiDian District, Beijing, China

David Comstock, John Lee, Zheng Shang, Jingning Zhu  
Huawei Technologies  
No.98, Lane91, Eshan Road, Shanghai,, China

IEEE C802.16j-07/101r7

<mailto:luyanling@hisilicon.com>,  
[fengsl@huawei.com](mailto:fengsl@huawei.com)

[dcomstock@huawei.com](mailto:dcomstock@huawei.com)  
Voice: +1 858 735 9382

---

Re:	A response to a Call for Technical Comments and Contributions regarding IEEE Project 802.16j, <a href="http://wirelessman.org/relay/docs/80216j-07_007r2.pdf">http://wirelessman.org/relay/docs/80216j-07_007r2.pdf</a>
Abstract	This contribution proposes the use of dedicated uplink channel as a bandwidth resource for RS to transmit upstream control signaling. This dedicated channel simplifies operation, minimizes delay and protocol overhead when compared with extending the existing bandwidth request and allocation mechanism for MMR network operation. The dedicated channel is also an effective control and transport mechanism for support of minimum delay in centralized multi-hop relay networks.
Purpose	To incorporate the proposed text into the P802.16j Baseline Document (IEEE 802.16j-06/026)
Notice	This document has been prepared to assist IEEE 802.16. It is offered as a basis for discussion and is not binding on the contributing individual(s) or organization(s). The material in this document is subject to change in form and content after further study. The contributor(s) reserve(s) the right to add, amend or withdraw material contained herein.
Release	The contributor grants a free, irrevocable license to the IEEE to incorporate material contained in this contribution, and any modifications thereof, in the creation of an IEEE Standards publication; to copyright in the IEEE's name any IEEE Standards publication even though it may include portions of this contribution; and at the IEEE's sole discretion to permit others to reproduce in whole or in part the resulting IEEE Standards publication. The contributor also acknowledges and accepts that this contribution may be made public by IEEE 802.16.
Patent Policy and Procedures	The contributor is familiar with the IEEE 802.16 Patent Policy and Procedures < <a href="http://ieee802.org/16/ipr/patents/policy.html">http://ieee802.org/16/ipr/patents/policy.html</a> >, including the statement "IEEE standards may include the known use of patent(s), including patent applications, provided the IEEE receives assurance from the patent holder or applicant with respect to patents essential for compliance with both mandatory and optional portions of the standard." Early disclosure to the Working Group of patent information that might be relevant to the standard is essential to reduce the possibility for delays in the development process and increase the likelihood that the draft publication will be approved for publication. Please notify the Chair < <a href="mailto:chair@wirelessman.org">mailto:chair@wirelessman.org</a> > as early as possible, in written or electronic form, if patented technology (or technology under patent application) might be incorporated into a draft standard being developed within the IEEE 802.16 Working Group. The Chair will disclose this notification via the IEEE 802.16 web site < <a href="http://ieee802.org/16/ipr/patents/notices">http://ieee802.org/16/ipr/patents/notices</a> >.

---

## **Dedicated Resource Assignment for RS**

*Derek Yu, Hang Zhang, Peiyong Zhu, Wen Tong, David Steer, Gamini Senarath, Mark Naden,  
G.Q. Wang  
Nortel*

*Byung-Jae Kwak, Dong-Seung Kwon, Sung-Cheol Chang, Dong-Hyun Ahn  
ETRI, Korea*

*Nah-Oak Song, Whan-Sun Kim  
MMPC, KAIST, Korea*

*Changkyoon Kim, Kyu Ha Lee, Hyung Kee Kim  
Samsung Thales, Korea*

*Wei-Peng Chen, Chenxi Zhu, Jonathan Agre  
Fujitsu Laboratories of America, USA*

*Aik Chindapol, Jimmy Chui, Hui Zeng  
Siemens Corporate Research, USA*

*Koon Hoo Teo  
Mitsubishi Electric Research Lab., USA*

*Kanchei (Ken) Loa, Yi-Hsueh Tsai, Shiann-Tsong Sheu, Hua-Chiang Yin, Yung-Ting Lee,  
Chih-Chiang Hsieh, Frank C.D. Tsai, Youn-Tai Lee, Heng-Iang Hsu  
Institute for Information Industry, Taiwan*

*Shulan Feng, Yanling Lu, Ting Li, Liangliang Zhang  
Hisilicon Technologies, Beijing, China*

*David Comstock, John Lee, Zheng Shang, Jingning Zhu  
Huawei Technologies, Shanghai, China*

### **1. Introduction**

The control information exchanged between an MR-BS and RSs includes channel quality information, bandwidth requests, topology change information, ranging information, and other control signaling. Excessive delay in this information transfer will have an adverse effect on the performance of the network. For efficient operation of the network (e.g., handover, improved throughput, backward compatibility with legacy MSs, etc), RSs should be able to deliver information to the MR-BS in a timely manner.

The basic mechanism by which bandwidth is allocated between the MR-BS and the RS is the contention bandwidth request and allocation procedure. The basic design of the bandwidth request and allocation procedure for 802.16e is based on the characteristics and requirements of MS. As an RS will be serving a number of MS(s), (and perhaps also a number of RSs) it will require frequent UL transmission to service the

concentration of traffic and changing requirements of the subtending MSs or RSs. The RS behavior and traffic requirements are different from that of an MS.

The transport mechanisms for control messages currently provided by the IEEE 802.16e are adequate for the operation of single hop access networks, but are less well suited for the purpose of relay networks. Figure 1 shows an example message flow chart, where an MS is taking a contention based bandwidth request procedure defined in Section 6.3.6.7.2 of 802.16j-06/026r2 (See also C802.16j-07/039r3.). For the purpose of transporting management messages, a more rapid mechanism is required.

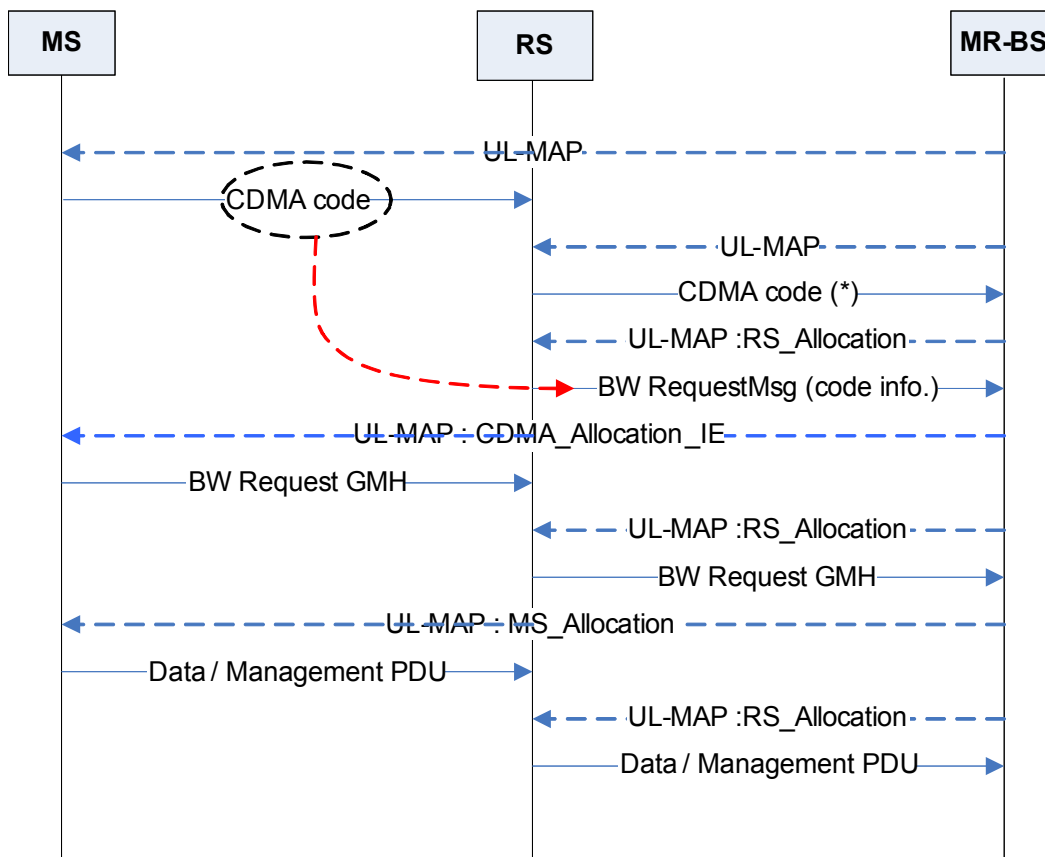

Figure 1 Contention based bandwidth request and allocation.

The contention based packet transmission scheme is event driven. This is efficient in terms of resource utilization for signalling from individual MSs. However, contention based bandwidth allocation is not as efficient for aggregated traffic from multiple MSs across RS to MR-BS links. When an RS needs to transmit many messages occurring periodically or randomly in time to the MR-BS, the need to send bandwidth request for every single control message is highly inefficient. In situations where there is considerable traffic at the RS it would be an advantage in efficiency if the RS could maintain a link to provide rapid response for this traffic. In situations where the traffic at the RS is light, then the event driven allocation scheme can be used.

## 2. Proposed Solution

The proposed solution to support efficient operation with dense traffic is to allocate a dedicated resource between an MR-BS and an RS for the purpose of transporting control messages or data traffic. By allocating uplink bandwidth to an RS, the RS can transmit control messages whenever necessary to the MR-BS without having to request bandwidth. Figure 2 illustrates this dedicated resource for a multi-hop network.

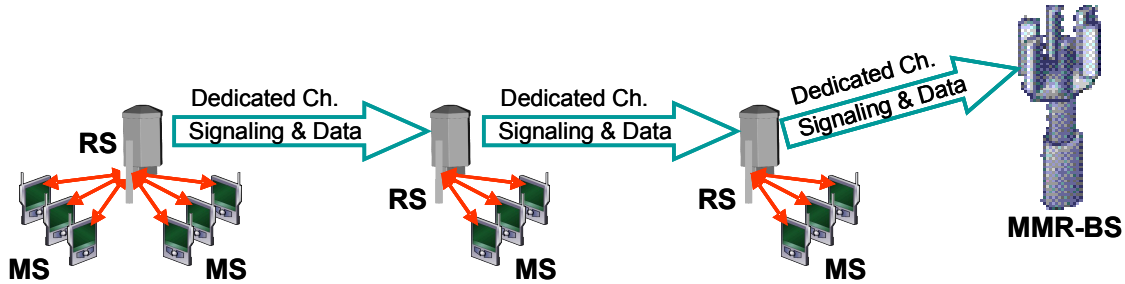

Figure 2: Multi-hop uplink transmission through dedicated channel allocation

The dedicated uplink channel enables a tight coupling between MR-BS with its RS(s) to serve MS effectively. It is applicable to both distributed and centralized resource management. For centralized management, the dedicated uplink resource provides efficient backhaul of control signaling messages to the MR-BS. For distributed management, signaling that can be handled locally is managed by the RS and requests to the MR-BS can be aggregated to further reduce the amount of signaling messages needed to go through the RS hops towards the MR-BS.

### Resource Allocation at RS Network Entry

After initial network entry procedure of an RS, a dedicated uplink channel may be allocated to the RS at the request of the RS or the MR-BS. If the MR-BS does not allocate a dedicated control channel to an RS, the RS can request an allocation.

The decision to allocate the dedicated channel may be made based on the traffic conditions at the RS. In a multi-hop relay network, some RS that are linked directly to the MR-BS and which forward traffic for a number of subordinate RS, will have a concentrated traffic flow which will benefit from a dedicated link and the reduced signaling and delay that would be required to request and assign resources for each uplink packet. In these situations of significant traffic, the reduction of signaling traffic and the consequent improvement in capacity for traffic outweighs the overhead that may be experienced at times when the traffic is light and not all capacity is being used. The allocation of the dedicated channel may be dynamic and adjusted in throughput to match the traffic and network conditions.

The RS will be assigned the minimum or larger size of dedicated resource by its upstream serving station (MR-BS or RS). The minimum size would be large enough for a signaling message, and would be available once every N frames. This initial resource is used by the RS to initiate the continuous operations of the dedicated channel. For example, the size can be updated, when appropriate, to a larger (or smaller) size according to the BW requirement of the RS. The BW requirement can be computed by the RS periodically, or as needed by traffic and signaling events, to ensure adequate signaling and data traffic flows. For centralized resource management, the initial assignment and all subsequent updates are done by the MR-BS only.

The dedicated channel allocation is assigned through R-MAP IE within the RS-Zone. The allocation is available starting in the same frame when the R-MAP IE is received by the RS. The R-MAP IE is the MAP information element used to allocate resources for the relay link.

If traffic conditions do not warrant the continued allocation of the dedicated resource, the MR-BS can terminate or decrease the bandwidth of the dedicated resource without request from the RS. The RS may request a decreased bandwidth or return the resource if it is no longer necessary.

The following figure 3 illustrates the allocation of the dedicated resource between an MR-BS and an RS. This figure indicates that a dedicated resource allocation is performed as part of the procedure whereby the RS joins the network. There is thereafter a persistent scheduling of the resource between the MR-BS and the RS. This resource may be used by the RS to respond to subsequent events with its subtending MSs.

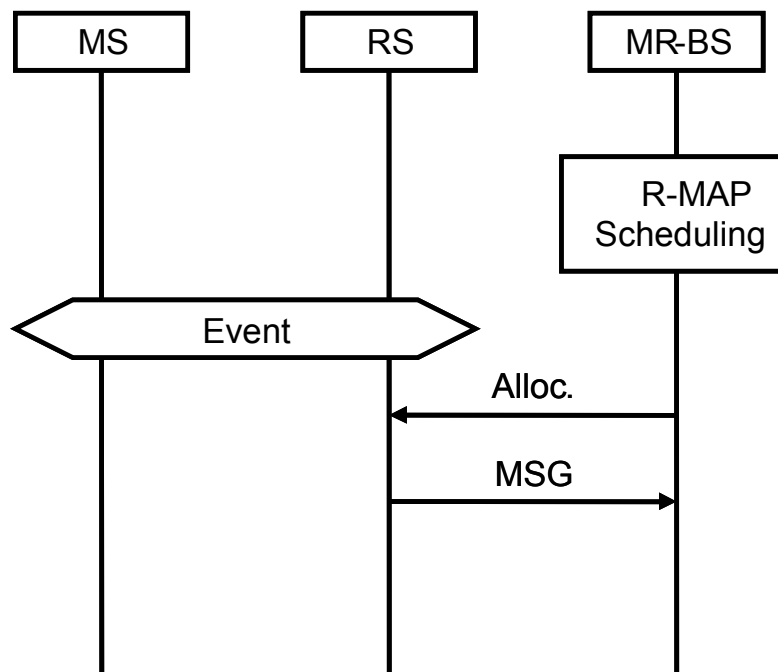

Figure 3: Allocation of dedicated resource between MR-BS and RS.

### Variable Resource Allocation

The bandwidth of the dedicated resource can be updated, when appropriate, to a larger (or smaller) value according to the BW requirements of the relay. The BW requirement can be computed or estimated, periodically or as needed by events, by the RS to ensure adequate signaling and data traffic flows. These events may include, for example: changes in traffic flows, changes in signaling requirements, detection of possible handover due to approaching MS, association of new MS (etc.).

### Rate based allocation

An RS may calculate the average data rate of a connection based on the traffic from the MSs. That is, the average data rate may be used to represent the long term statistics of the MSs. The dedicated resource may be set initially based on the measured statistics or adjusted at other times to match changing traffic statistics.

Due to fluctuations in the traffic there will be cases when the dedicated resource does not perfectly accommodate the traffic needs. When the dedicated resource is not large enough to handle the traffic, the bandwidth request procedure will be used to request and allocate additional resources. If the dedicated resource is greater than required, the MR-BS or the RS may reduce or return the dedicated allocation.

Note that the rate based allocation mechanism is particularly useful to the near-constant bit rate connections such as rtPS, ertPS, and nrtPS. On the other hand, since a bursty connection (e.g. a BE connection) might show a large fluctuation in BR, an RS may aggregate BRs of bursty connections from the same class.

### 3. Delay Analysis: Multihop Delay Benefit with Dedicated Allocation

The following analysis provides some guidelines on how dedicated resources are allocated at MRBS as well as for the multihop relays. It also demonstrates the delay benefit for best effort traffic when comparing with BW request mechanisms described in the baseline text.

#### Resources Availability at MRBS and Relay

The simplified illustration in Figure 4 describes the resources availability at both the MRBS and relay for supporting multihop UL data transfer. The MRBS is serving four 1st hop relays, whereas RS<sub>12</sub> is serving two 2nd hop relays (RS<sub>21</sub> & RS<sub>22</sub>).

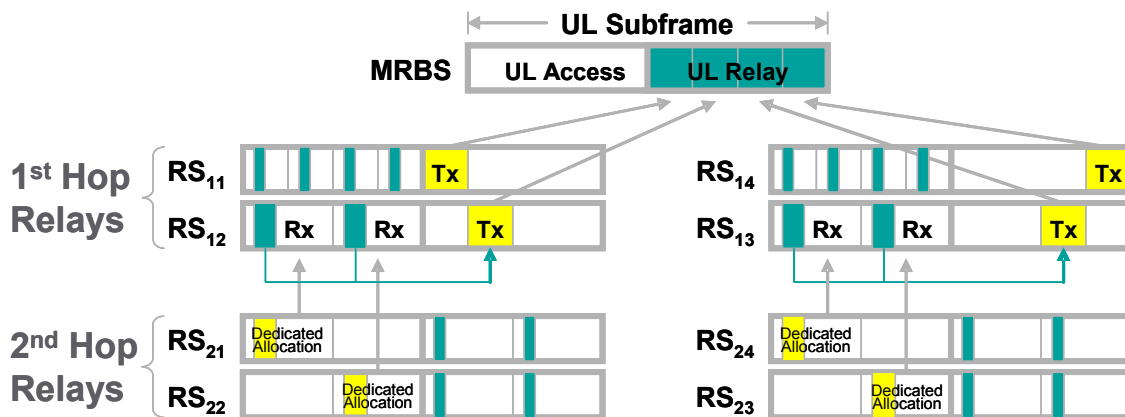

Figure 4: Resources Availability at MRBS and Relay.

The size of the colored blocks depicts the actual average resources used by each relay for data traffic upload. Each of the four 1st hop relays contributes, on average, a quarter of the traffic to fill up the UL relay resource at MRBS. As indicated, the second hop relays (RS<sub>21</sub> & RS<sub>22</sub>) are allocated four times the resources needed by

their parent RS<sub>12</sub> and the overall throughput capacity is not impacted even when the 2nd hop relays, on average, only use one quarter of the allocated bandwidth. As such it is possible for loosely dedicated resource allocation at the relay to its child relays. In terms of aggregate capacity, BW resources are not wasted unless they are wasted at the MRBS. Hence, a tighter UL dedicated resources management can be applied to the first hop when needed.

### Analysis Assumptions

The following are the assumptions used for the analysis:

Best effort traffic: single burst upload.

Three hop connection.

First hop UL dedicated resources are allocated once every frame but enough for a BW request header. After receiving a BW request header, the MRBS can allocate additional resources as requested. As the first hop link is the final concentrated link to the MRBS, the dedicated resources are expected to be filled when the network is loaded.

All subsequent hops, the UL dedicated resources are also allocated once every frame but for both signaling and data traffic.

For dedicated resource under centralized allocation, each RS that serves mobiles has dedicated resources already pre-allocated by the MRBS to the RS to serve its mobiles. The RS can use these pre-allocated resources to grant BW request to any of its mobiles.

### Analysis Results

The flow of signaling and data burst based on the dedicated resource allocation and BW request in the baseline text are shown in Figure 5 and 6 respectively.

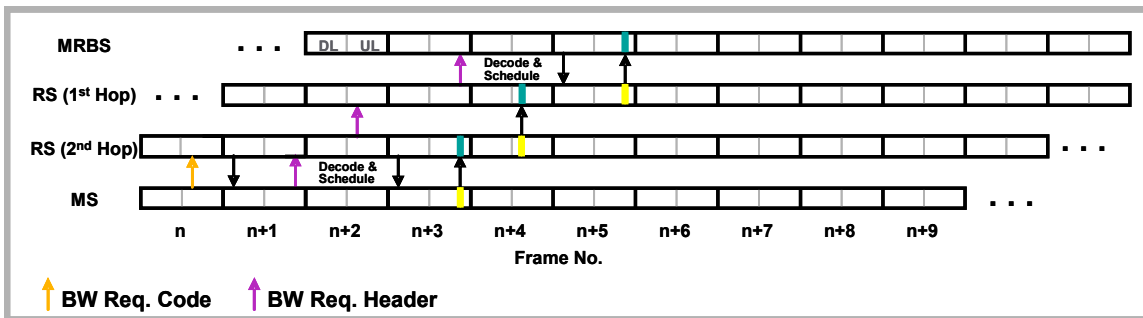

Figure 5: Delay Analysis for Dedicated Resource Allocation.

With dedicated resource allocation, shown in Figure 5 for a three hops link, the MS UL delay to transmit a burst of data is 6 frames from the first frame when the MS sends in the BW request ranging code. The MS UL delay can be generalized to the following:

$$\text{MS Tx Delay for UL burst} = H + 3, \text{ where } H \text{ is the number of hops the MS is from the MRBS.}$$



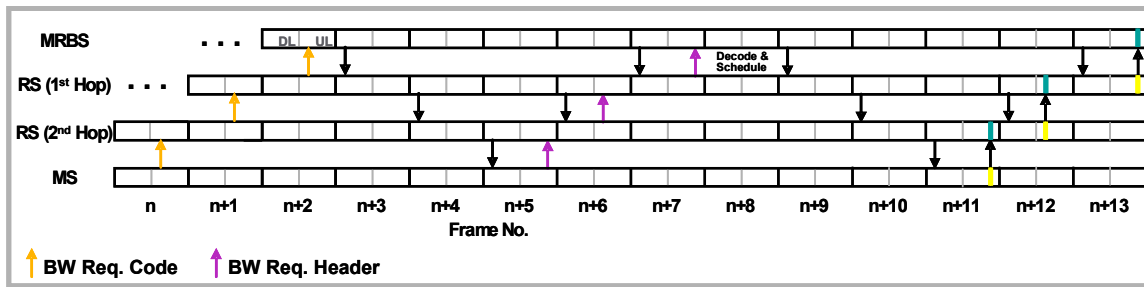

Figure 6: Delay Analysis for BW Request in Baseline Text.

For the case with the BW request in the baseline text, shown in Figure 6 for the same three hops link, the MS UL delay to transmit a burst of data is 14 frames. The MS UL delay can be generalized to the following:

$$\text{MS Tx Delay for UL burst} = 5H - 1, \text{ where } H \text{ is the number of hops the MS is from the MRBS.}$$

The results summary of the delay analysis is shown in Figure 7. When comparing the BW request in the baseline text with the dedicated approach, the baseline BW request incurs 5 : 1 in additional delay for each additional hop added to the path.

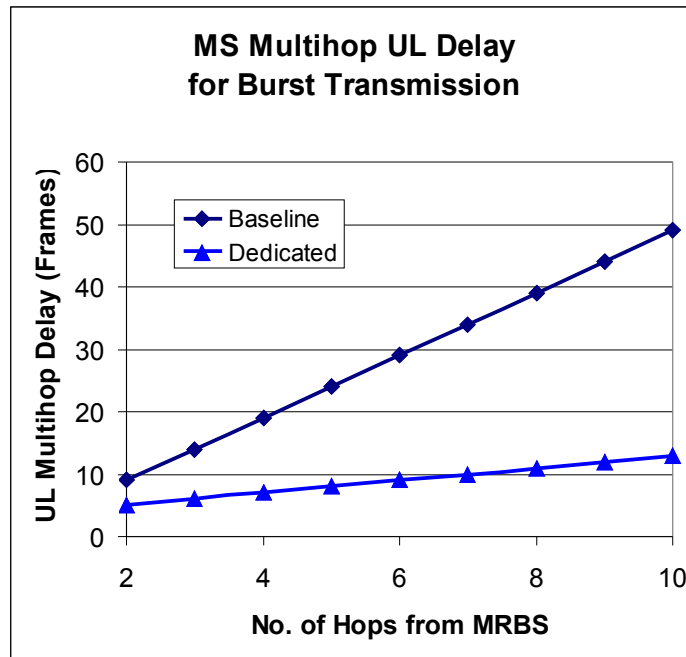

Figure 7: Summary of Delay Analysis.

With dedicated resource allocation, the MS Multihop UL delay can be significantly improved for both control and data traffic.

## 4. Text Proposal

### 4.1 Dedicated relay uplink channel allocation using request header

+++++ Start Text Proposal +++++

*[Change subclause 6.3.2 as indicated – note that this format is intended to be compatible with others also using MAC header for RS signalling]*

*[modify table X-1 the following subclause at the end of 6.3.2.1.2.2:]*

#### 6.3.2.1.2.2.2 Extended MAC Signaling Header Type II

Table X-1—Extended Type field encodings for Extended MAC signaling header type II

<u>Extended Type field</u>	<u>MAC header Type</u>	<u>Reference figure</u>	<u>Reference table</u>
<u>0</u>	<u>Relay Bandwidth Request Header</u>		
<u>1</u>	<u>RS UL_DCH Request Header</u>		
<u>2-7</u>	<u>Reserved</u>		

#### 6.3.2.1.2.2.2.2 RS UL DCH Request Header

The RS requests a dedicated uplink resource through the RS UL\_DCH request header. This header is as follows:

HT = 1 (1)	EC = 1 (1)	Type = 1 (1)	Extended Type (3)	Type (MSB) (2)
Type (LSB) (2)		DCH Type (2)	Header content (4)	
Header content (8)				
Header content (8)				
Header content (8)				
HCS (8)				

Figure XXX – RS UL\_DCH request header

Syntax	Size	Notes
MAC Header() {		
RMI	3 bits	Relay mode indication: "111" = this MPDU uses 802.16j relay format, others = this MPDU uses legacy 802.16e format
if (RMI == 111) {		<b>relay MAC PDU format</b> will be used
Extended TYPE	3 bits	
if (Extended TYPE == 001) {		RS UL_DCH request header
TYPE	4 bits	0000 = DCH Request 0001 to 1111 = Reserved
if (TYPE == 0000) {		If <b>DCH Request</b>
DCH TYPE	2 bits	00 = DCH Request Incremental 01 = DCH Request Aggregate 10 = DCH Request Rate Based 11 = Reserved
if (DCH TYPE == 00) {		If <b>DCH Request Incremental</b>
Bandwidth Request	16 bits	Number of bytes requested by the RS. Zero in this field indicates DCH release request
N	4 bits	Allocation repeats once every N frames
} else (DCH TYPE == 01) {		If <b>DCH Request Aggregate</b>
Bandwidth Request	16 bits	Number of bytes requested by the RS. Zero in this field indicates DCH release request
N	4 bits	Allocation repeats once every N frames
} else (DCH TYPE == 10) {		If <b>DCH Request Rate Based</b>
Progressive rate	12 bits	Average data rate with the progressive resolution unit.
Reserved	8 bits	Reserved
}		
RS CID	8 bits	Reduced Basic CID of RS
}		
}		
HCS	8 bits	Header check sequence
}		

Table XXX RS UL-DCH header

*[Change subclause 6.3.6 as indicated]*

### 6.3.6 Bandwidth allocation and request mechanism

**During** network entry and initialization every SS is assigned up to three dedicated CIDs for the purpose of sending and receiving control messages. These connection pairs are used to allow differentiated levels of QoS to be applied to the different connections carrying MAC management traffic. Increasing (or decreasing) bandwidth requirement is necessary for all services except incompressible constant bit rate UGS connections. The needs of incompressible UGS connections do not change between connection establishment and termination. The requirements of compressible UGS connections, such as channelized T1, may increase or decrease depending on traffic. Demand Assigned Multiple Access (DAMA) services are given resources on a demand assignment basis, as the need arises.

When an SS needs to ask for bandwidth on a connection with BE scheduling service, it sends a message to the BS containing the immediate requirements of the DAMA connection. QoS for the connection was established at

connection establishment and is looked up by the BS.

An RS may request a dedicated uplink resource with the bandwidth request R-MAC header RS\_UL\_DCH Request.

There are numerous methods by which the SS can get the bandwidth request message to the BS. The methods are listed in 6.3.6.1 through 6.3.6.7.

#### 6.3.6.7 Relay bandwidth request and allocation mechanisms

*[Add the following section]*

##### 6.3.6.7.3 Dedicated relay uplink channel allocation

After the RS network entry and initialization, the RS may be assigned an uplink dedicated channel (RS\_UL\_DCH) resource by its upstream serving station (MR-BS or RS). If the MR-BS does not allocate an uplink dedicated channel to an RS, the RS may request an allocation.

The minimum size is large enough for a signaling message, it is available once every N frames. This initial resource is used by the RS to initiate the continuous operations of the dedicated channel. For example, the size can be updated, when appropriate, to a larger (or smaller) size according to the traffic requirement of the relay. The traffic requirement can be computed, periodically or as needed by events, by the RS to ensure adequate flows. For centralized resource management, the initial assignment and all subsequent updates may be done by the MR-BS only. In distributed resource management, the dedicated channel assignment may be done jointly by the MR-BS and the RS.

The dedicated channel allocation is assigned through MAP IE within the RS-Zone, i.e. R-MAP. The allocation is available starting in the same frame when the R-MAP IE is received by the RS.

## **4.2 R-MAP IE definition for dedicated relay uplink channel allocation**

*[Add the following section]*

### 8.4.5.9 MAP IE (within R-MAP)

#### 8.4.5.9.1 RS\_UL\_DCH assignment IE

This IE is used for the initial allocation and subsequent updates of the uplink dedicated channel on the R-link.

Table XXX. RS\_UL\_DCH assignment IE format.

Syntax	Size	Notes
<u>RS_UL_DCH assignment IE {</u>		
<u>  Type</u>	<u>4 bits</u>	
<u>  RSCID</u>	<u>8 bits</u>	<u>Reduced basic CID of the RS</u>
<u>  UL Resource allocation</u>	<u>x bits</u>	<u>Resources allocated to DCH</u>
<u>  Frequency (N)</u>	<u>4 bits</u>	<u>Allocation repeats once every N frames</u>
<u>}</u>		

The coding for the UL resource allocation to the DCH is TBD

### 4.3 Dedicated relay uplink channel allocation using MAC management messages

*[Insert new subclause 6.3.6.8:]*

#### 6.3.6.8 Bandwidth request and allocation mechanisms for MMR

##### 6.3.6.8.1 Dedicated channel between MR-BS and RS

An RS or MR-BS may allocate a dedicated channel using RS\_UL\_DCH (see 6.3.2.xxxx). A dedicated channel is a periodic allocation of uplink bandwidth.

To reduce the overhead of allocating a dedicated channel to an RS, a dedicated channel can be allocated, changed, and released based on the expected demand of the uplink bandwidth.

MR-BS may allocate a dedicated channel to an RS without an explicit request from the RS by sending a RS\_UL\_DCH (see 6.3.2.xxxx).

If necessary, an MR-BS can terminate or decrease the bandwidth and/or the allocation interval of the dedicated channel without request from an RS.

If the uplink path from an RS to an MR-BS includes other RSs, the MR-BS allocates a dedicated channel for each hop within the path in response to an RS\_UL\_DCH.

++++ End Text Proposal +++++