

Project	<b>IEEE 802.16 Broadband Wireless Access Working Group</b> < <a href="http://ieee802.org/16">http://ieee802.org/16</a> >	
Title	<b>An Evolved Frame Structure and the use of fractional OFDMA symbols</b>	
Date Submitted	<b>2008-01-23</b>	
Source(s)	Kiran Thakare, Per Ernström, S. Shawn Tsai Ericsson AB SE-164 80 Stockholm, Sweden	Voice: +46 8 58532591 E-mail: <a href="mailto:per.ernstrom@ericsson.com">per.ernstrom@ericsson.com</a>
Re:	IEEE 802.16m-07/047 - Call for Contributions on Project 802.16m System Description Document (Frame structure)	
Abstract	<p>The IEEE standard 802.16m is intended to be an evolution of IEEE WirelessMAN-OFDMA targeting requirements for lower latency and backward compatibility as per [1].</p> <p>Within this framework, we propose an Evolved Frame Structure for 802.16m.</p>	
Purpose	<p>To create a Physical Layer Chapter with a Frame Structure section in the System Description Document (SDD).</p> <p>To include the proposed evolved frame structure in frame structure section of the physical layer chapter of SDD.</p>	
Notice	<p><i>This document does not represent the agreed views of the IEEE 802.16 Working Group or any of its subgroups. It represents only the views of the participants listed in the "Source(s)" field above. It is offered as a basis for discussion. It is not binding on the contributor(s), who reserve(s) the right to add, amend or withdraw material contained herein.</i></p>	
Release	<p>The contributor grants a free, irrevocable license to the IEEE to incorporate material contained in this contribution, and any modifications thereof, in the creation of an IEEE Standards publication; to copyright in the IEEE's name any IEEE Standards publication even though it may include portions of this contribution; and at the IEEE's sole discretion to permit others to reproduce in whole or in part the resulting IEEE Standards publication. The contributor also acknowledges and accepts that this contribution may be made public by IEEE 802.16.</p>	
Patent Policy	<p>The contributor is familiar with the IEEE-SA Patent Policy and Procedures:  <a href="http://standards.ieee.org/guides/bylaws/sect6-7.html#6">http://standards.ieee.org/guides/bylaws/sect6-7.html#6</a> and  <a href="http://standards.ieee.org/guides/opman/sect6.html#6.3">http://standards.ieee.org/guides/opman/sect6.html#6.3</a>.  Further information is located at <a href="http://standards.ieee.org/board/pat/pat-material.html">http://standards.ieee.org/board/pat/pat-material.html</a> and  <a href="http://standards.ieee.org/board/pat">http://standards.ieee.org/board/pat</a>.</p>	

# An Evolved Frame Structure and the use of fractional OFDMA symbols

*Kiran Thakare, Per Ernström, Shawn Tsai*  
Ericsson AB Sweden

## 1. Introduction

This contribution discusses the basic frame structure aspect of the IEEE WirelessMAN-OFDMA and proposes a new frame structure for the IEEE 802.16m physical layer. The IEEE 802.16m standard is intended to be an evolution of IEEE WirelessMAN-OFDMA with the requirements on lower latency and backward compatibility. The new proposal for an evolved frame structure for IEEE 802.16m reduces the round-trip latency and CQI latency. Further more, the introduction of fractional OFDMA symbols, allows for better optimization of transition gap times, and thus an improvement in capacity. Additionally it satisfies the backward compatibility requirement as specified in [1].

We propose that a section on a frame structure be added into the system description document. We additionally propose to include the new evolved frame structure and the subsequent text, in the frame structure section of the System Description document.

Several, but not all, of the solutions presented in this document were described in [4], presented for information at session #52.

## 2. WirelessMAN-OFDMA Frame Structure

The frame structure used in IEEE WirelessMAN-OFDMA is shown in Figure 1.

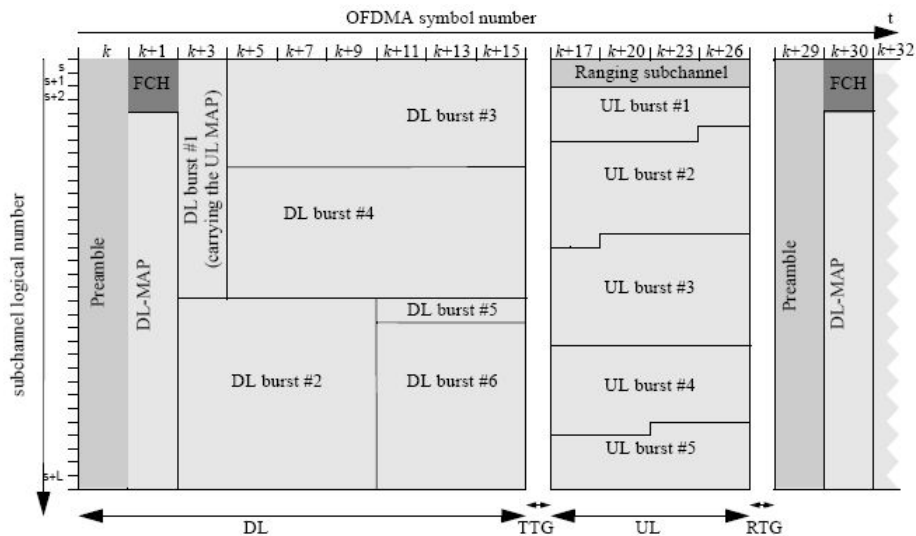

Figure 1: Frame structure used in IEEE WirelessMAN-OFDMA. The frame length is 5ms.

The IEEE802.16m systems requirement document [1] requires higher performance for higher mobility classes. WirelessMAN-OFDMA [2] uses a 5ms frame length, thus limiting the CQI reporting to 5ms and hence degrading the mobility performance.

In WirelessMAN-OFDMA, the BS can send a data block in Frame 1, and the MS can send a NACK in Frame 2, allowing for processing delay at the MS. With processing and scheduling delay at the BS, a retransmission can be sent in Frame 4.

IEEE 802.16m [1] requires that data latency for DL between MS and BS, be <10ms. In the case of retransmission this requirement implies that the retransmission has to be sent in the very next frame after a

transmission. This is only possible if the NACK is sent by the MS in the same 5ms frame, and the BS reacts immediately to the NACK to send the retransmission. This introduces significant processing burden on the BS and the MS.

### 3. Proposed Evolved Frame Structure

The proposal for an evolved frame structure for IEEE 802.16m reduces the latency requirements and satisfies the backward compatibility requirement as specified in [1]. The evolved frame structure is shown in Figure 2.

The 5ms frame is divided into two 2.5 ms sub-frames for the purposes of illustration. Each sub-frame has a downlink portion and an uplink portion. Sub-frame 1 constitutes of DL Burst 1 and UL Burst 1 and sub-frame 2 consists of DL Burst 2 and UL Burst 2. These four consecutive bursts: DL Burst 1, UL Burst 1, DL Burst 2, and UL Burst 2 are separated by TTG1, RTG1, TTG2 and RTG2 gaps as shown in Figure 2.

In figure 2, the preamble is not present in the DL part of sub-frame 2 additionally the ranging sub-channel is not present in the uplink part of sub-frame 1. These functionalities are present in DL Burst 1 and UL Burst 2, however they need not be repeated in DL Burst 2 and UL Burst 1, but can be optionally included as shown in Figure 3. The offset of UL Burst 1 from the beginning of sub-frame 1 may be different from the offset of UL Burst 2 from the beginning of sub-frame 2.

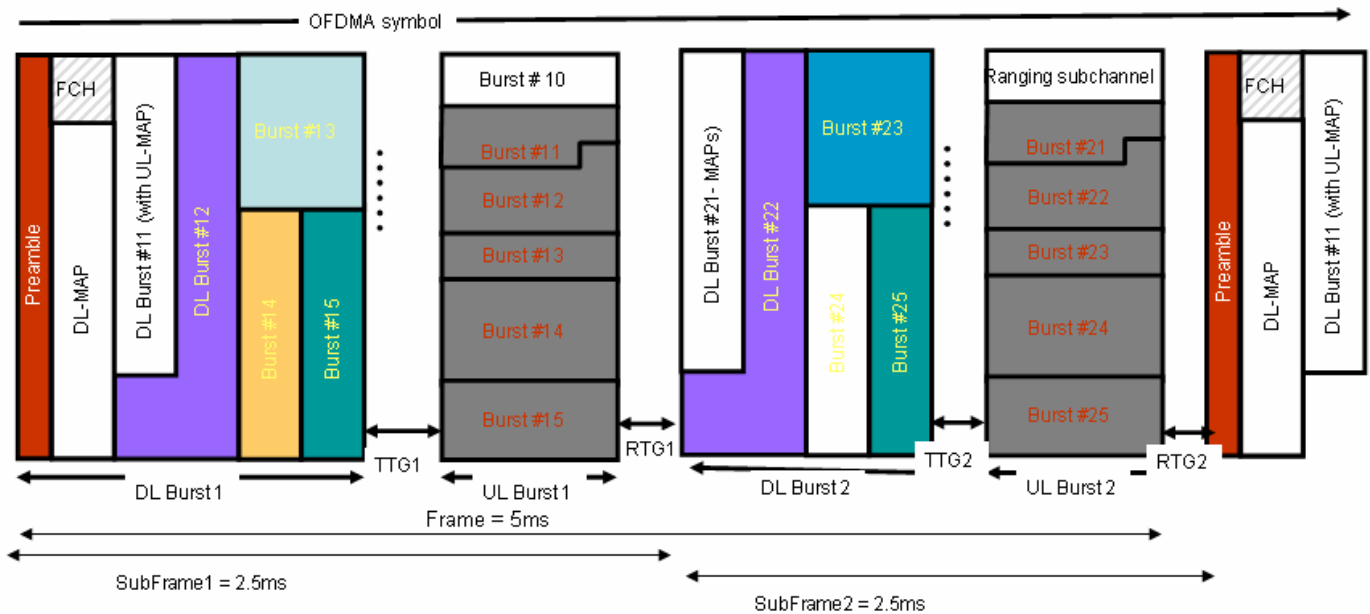

Figure 2: Proposed Frame Structure Showing the Two Sub-frames for IEEE 802.16m

New users can be allocated either to DL/UL Burst 1 and or DL/UL Burst 2. The relevant signaling of information elements is achieved using DCD, UCD and UL/DL MAP messages. New IE's are needed so that the new mobile stations can fully exploit the new frame structure and the features available with it.

The modified new DL/UL MAP message is sent in DL-Burst 1 for allocating the resources to new users in UL/DL Burst 1, UL/DL Burst 2. Additionally such a message may be sent in the DL-Burst 2 for allocating the resources to new users in UL/DL Burst 2.

The UL-MAP sent in subframe1 could use the existing "Allocation Start time" IE to signal the start of UL Burst 2. Similarly an additional new IE is required to signal the start of UL Burst 1 for new users.

The gaps namely TTG1, RTG1 and TTG2, RTG2 are signaled respectively in the new and existing IE's of the existing DCD message.

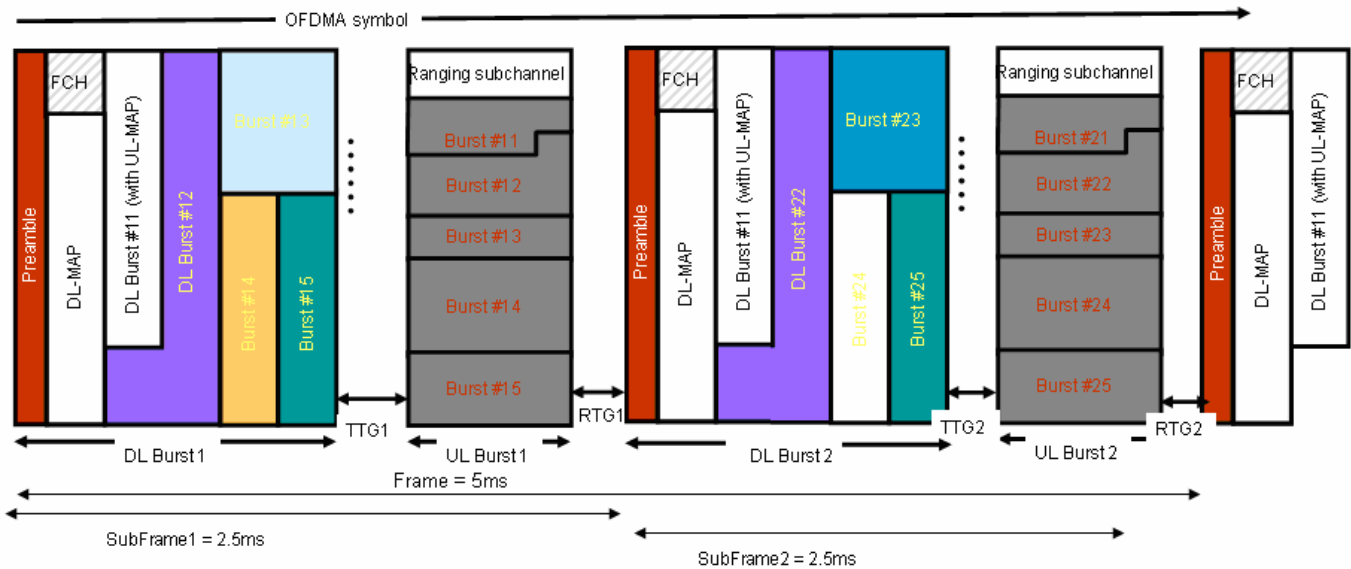

Figure 3 Proposed frame structure with optional preamble, FCH, DL-MAP and UL-MAP in DL Burst 2, and ranging subchannel in UL Burst 2. The preamble signatures in DL burst 1 and DL burst 2 are different.

### 3.1 Latency Requirement

IEEE 802.16m [1] requires that data latency for DL and UL between MS and BS be <10ms. With the evolved frame structure, new mobile stations can receive the DL transmission in DL Burst 1, send an ACK/NACK in UL Burst 2, and receive a retransmission in DL Burst 2 of the next frame. Thus, the new frame structure allows for lower round trip latency due to ACK/NACK response in the same frame.

The IEEE802.16m [1] requires higher performance for higher mobility classes. With the proposed evolved frame structure, a new mobile station has the possibility to report CQI in every sub-frame i.e. every 2.5ms. Thus the new frame structure allows for higher mobility performance of a high speed mobile station as required by [1].

### 3.2 Backward compatibility Requirement

Figure 4, shows how the proposed new evolved frame structure appears to legacy mobile stations.

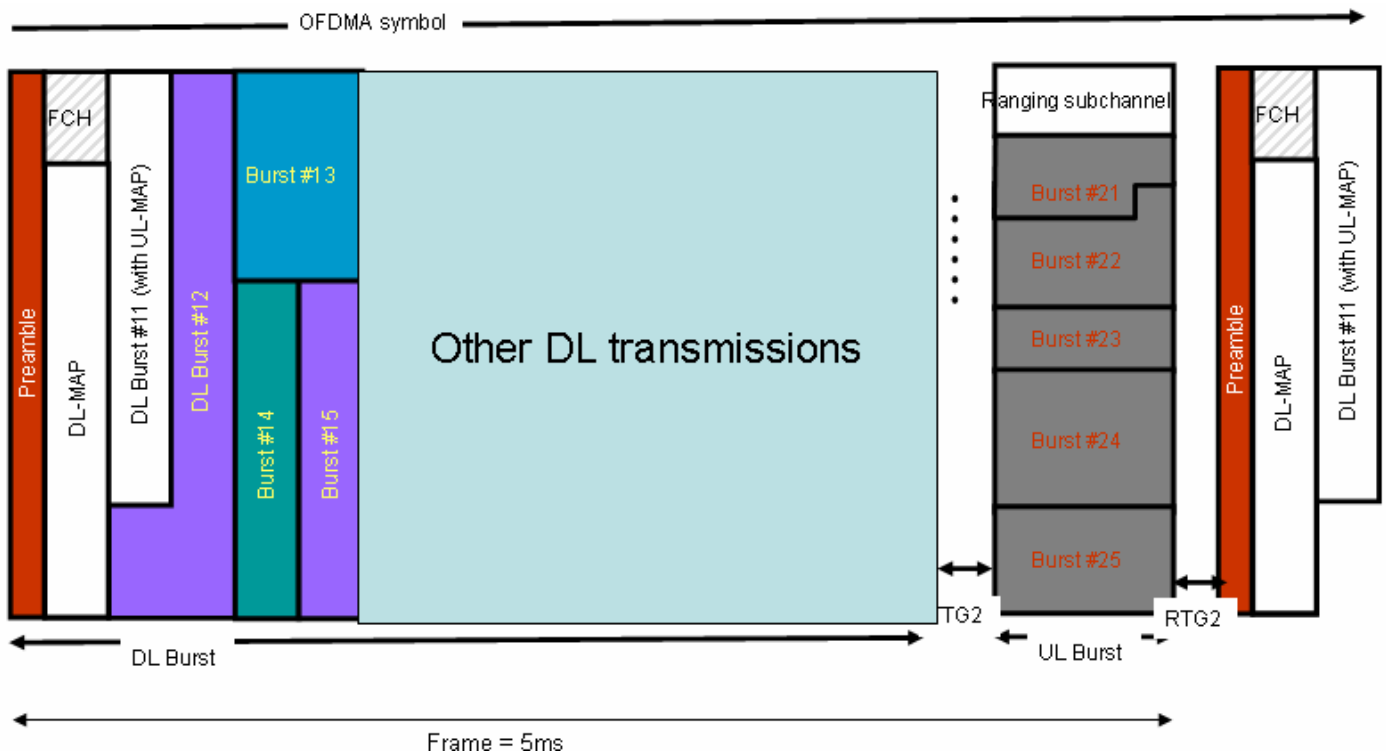

Figure 4 Proposed frame as seen by a Legacy MS

Backward compatibility requirement [1] is met as follows:

1. The relevant signaling is proposed to be carried out in the relevant UL/DL MAP and UCD/DCD messages such that the modification is totally transparent to legacy MS.
2. The part of the frame, shown in figure 2, between DL Burst 1 and UL Burst 2 will not be assigned to any legacy mobile stations and will appear as other downlink transmissions. Typically, this may be seen as DL transmission using a zone that is not supported by the MS. The DL-MAP message is sent in DL Burst 1 and is used to allocate DL resources to legacy mobile station in DL Burst 1.
3. IEEE WirelessMAN-OFDMA defines the start of the UL part of the frame using the “Allocation Start Time” IE in the UL-MAP message. This existing IE “Allocation Start Time” is used to signal the beginning of UL Burst 2 to the legacy mobile stations. The mobile station will be able to act on the IE, treating UL Burst 2 as the UL part of the 5ms frame.
4. The TTG and RTG in IEEE WirelessMAN-OFDMA are signaled in the DCD message. The same TTG, RTG values can be used as TTG2 and RTG2 values for the legacy mobiles. The operation is transparent to the legacy mobile.

In a scenario where an operator upgrades a legacy IEEE WirelessMAN-OFDMA carrier to support the advanced air-interface, the terminal fleet can initially be expected to be dominated by legacy terminals. During this initial phase it is beneficial to utilize the optional preamble, FCH, DL-MAP and UL-MAP in DL Burst 2, and the ranging subchannel in UL Burst 1, as shown in Figure 5. This allows an interpretation of the evolved frame in terms of two interlaced partially blanked out legacy frames, as seen by legacy terminals. This makes it possible to allocate all resources to legacy terminals. One group of legacy terminals will consider DL burst 1 as the beginning of a legacy frame, and may be allocated resources in DL Burst 1 and UL Burst 2. A second group of legacy terminals will consider DL burst 2 as the beginning of a legacy frame, and may be allocated resources in DL Burst 2 and UL Burst 1. For load balancing purposes a normal handover procedure can be used to move legacy terminals between the two groups.

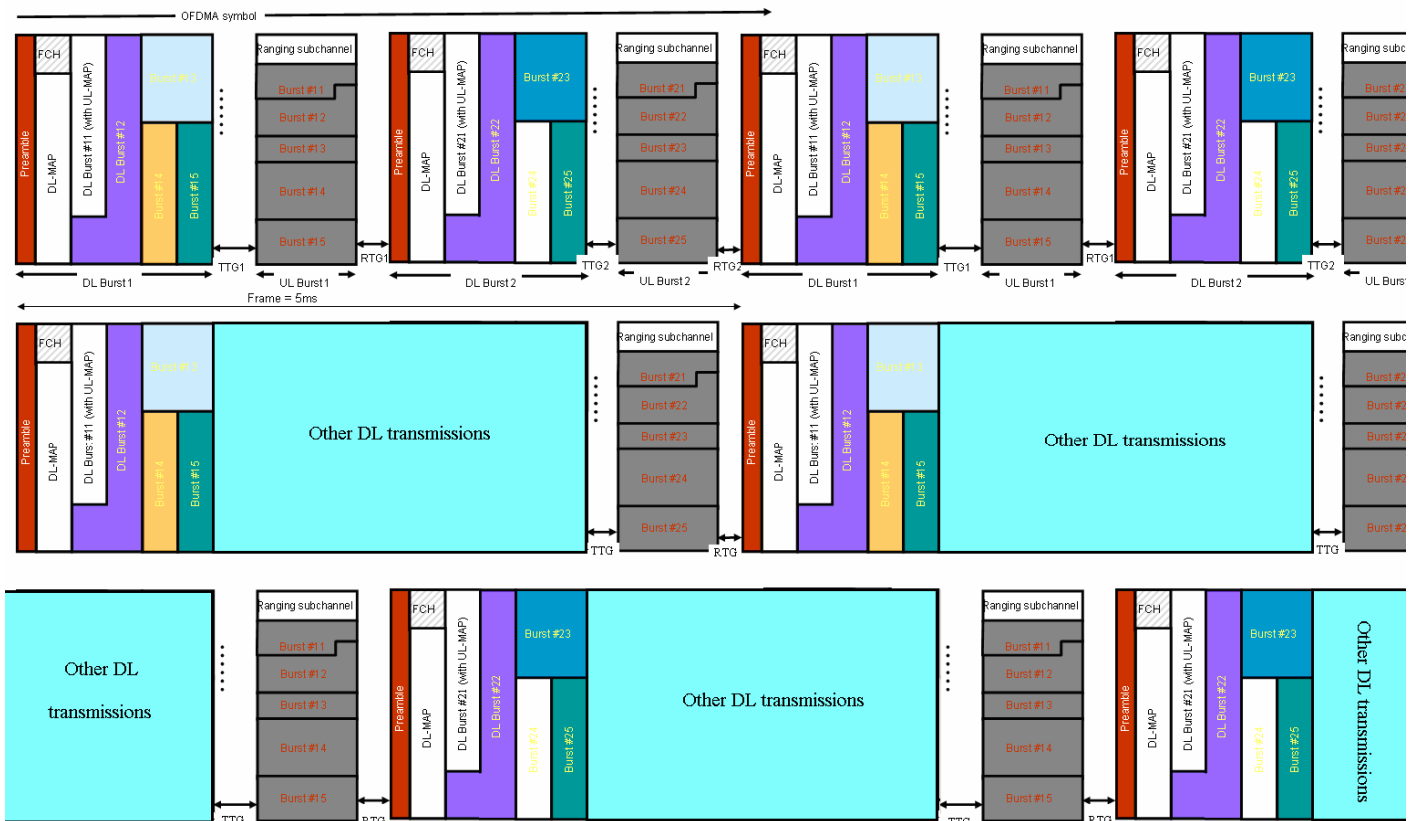

Figure 5 The top row shows the proposed evolved frame structure with preamble in DL Burst 2 allowing an interpretation in terms of interlaced legacy frames. The middle row illustrates how a first group of legacy terminals view and use this frame. The bottom row illustrates how a second group of legacy terminals view and use this frame. Since all resources can be used both for new and for legacy terminals, there is no loss in system capacity even when the terminal fleet is dominated by legacy terminals, as it is likely to be at roll-out when a legacy network is upgraded.

### 3.3 RTG TTG Gaps

The IEEE 802.16m new proposed frame structure includes the following TTG/RTG gaps: TTG1, TTG2, RTG1 and RTG2.

The RTG and TTG gap values in the current WiMax Mobile System profile [2] are significantly higher values than required by most deployment environment. Thus the total gap duration in the proposed IEEE 802.16m frame structure could easily fit within the overall WirelessMAN-OFDMA budget for gap duration.

To reduce the impact of TTG1 and RTG1 as shown e.g. in Figure 2 and Figure 3, a technique called fractional OFDM symbol usage can be applied. The fractional OFDM symbol signal can be generated by the same fast Fourier transform (FFT) operation. The idea is to use the orthogonality between subcarriers of a specific subset over a smaller time support. The fractional OFDM symbol usage can be used to fill-up the unused space left by the insertion of new TTG/RTG. Detailed description on the fractional OFDM symbol usage is given in the appendix. The fractional OFDM symbols may also be used to utilize part of the “legacy RTG and TTG” for 16m data/signalling transmissions.

A set of evenly spaced tones with fractional symbol duration can solve the problem of wasting integer number of OFDM symbols for new transition gaps in Figure 2, as they may be too long for the TTG and RTG. In 5MHz IEEE 802.16 reference systems, the OFDMA symbol duration is 102 $\mu$ s, while the TTG and the RTG are 105 $\mu$ s and 60 $\mu$ s, respectively. Since the new DL and UL are inside the legacy DL subframe, the summation of TTG, RTG and the new DL/UL symbol durations must be equal to an integer multiple of OFDM symbols. If the length of new TTG/RTG combined is not equal to an integer number of OFDM symbol, extra OFDM symbol will be lost as the available time for data transmission rounds off for the remaining OFDM symbols.

In addition, as depicted in Figure 2, if UL1 is used partially for a relay station and its subordinate MS treats UL1 as downlink, then another constraint to align UL1 symbol timing with the legacy DL symbol timing would apply. In that scenario, without fractional usage of OFDM symbol, TTG1 will take at least one symbol, even if it is allowed to be less than 1 OFDM symbol. If the 105 $\mu$ s TTG for 5MHz is chosen, then the loss will be 2 OFDM symbols simply because the TTG is 3 $\mu$ s longer than the 102 $\mu$ s OFDM symbol. If a TTG of 1/2 OFDM symbol is sufficient, then with the fractional OFDM symbol usage the remaining 1/2 OFDM symbol can still be used for data transmission. By the fractional usage of OFDM symbol, the starting point of the new TTG1 can be pushed to a fractional OFDM symbol time after the end of DL1, while that fractional OFDM symbol can still be used for data transmission with reduced peak rates.

### 3.4 Co-deployment and co-existence with legacy network

In [5] it was proposed to partially blank out the frames of the legacy network to facilitate co-deployment and co-existence between a legacy WirelessMAN-OFDMA network and a network based on the advanced air interface and an evolved frame structure with additional switching points. This mechanisms should work well, but would obviously reduce the capacity in the blanked out part of the legacy network.

Here we propose as a further development, that the legacy base station transmit two interlaced partially blanked out legacy frames, with different preamble signatures, as illustrated in Figure 6. This way the legacy BS RX and TX periods coincide with the RX and TX periods of a BS supporting the advanced air interface and the evolved frame structure, and as a consequence the interference problems are eliminated.

A terminal will view the two interlaced legacy frames as coming from different base stations. Some of the terminals will utilize the first of the interlaced frame, while the remaining terminals will utilize the second interlaced frame, and thus no resources are left unused. A normal handover procedure can be used for load balancing purposes in between the two interlaced frames.

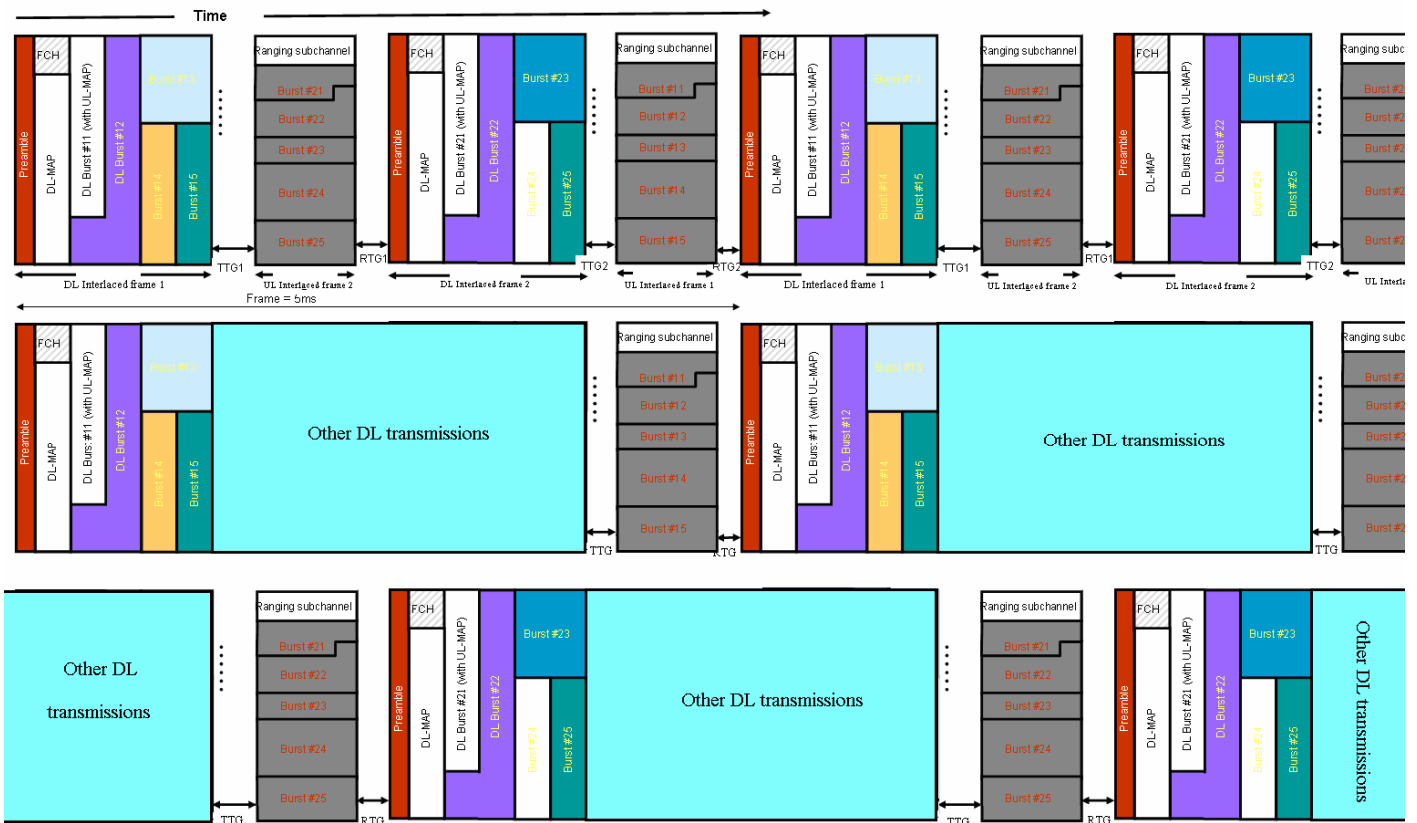

Figure 6 The top row shows two interlaced partially blanked out legacy frames transmitted from the same BS. The middle row illustrates how a first group of terminals view and use one of the two interlaced partially blanked out legacy frames. The bottom row illustrates how a second group of terminals view and use the other of the two interlaced partially blanked out legacy frames. Since the two interlaced frames fill out the blanked out part of the other frame, no resources are wasted.

The technique with the two interlaced partially blanked out legacy frames can be deployed in the whole network surrounding a region where the advanced air interface and the evolved frame structure has been deployed. Alternatively it can be limited to a small region B surrounding the region A where the advanced air interface and the evolved frame structure has been deployed, as illustrated in Figure 7. In this case a second “buffer” region C surrounding region B is needed to eliminate interference. Here the technique with one partially blanked out legacy frame is deployed. Outside region C, the full legacy frame may be used.

It should be possible to implement both the technique with one partially blanked out legacy frame, and the technique with two interlaced partially blanked out legacy frames through a software upgrade of a legacy network.



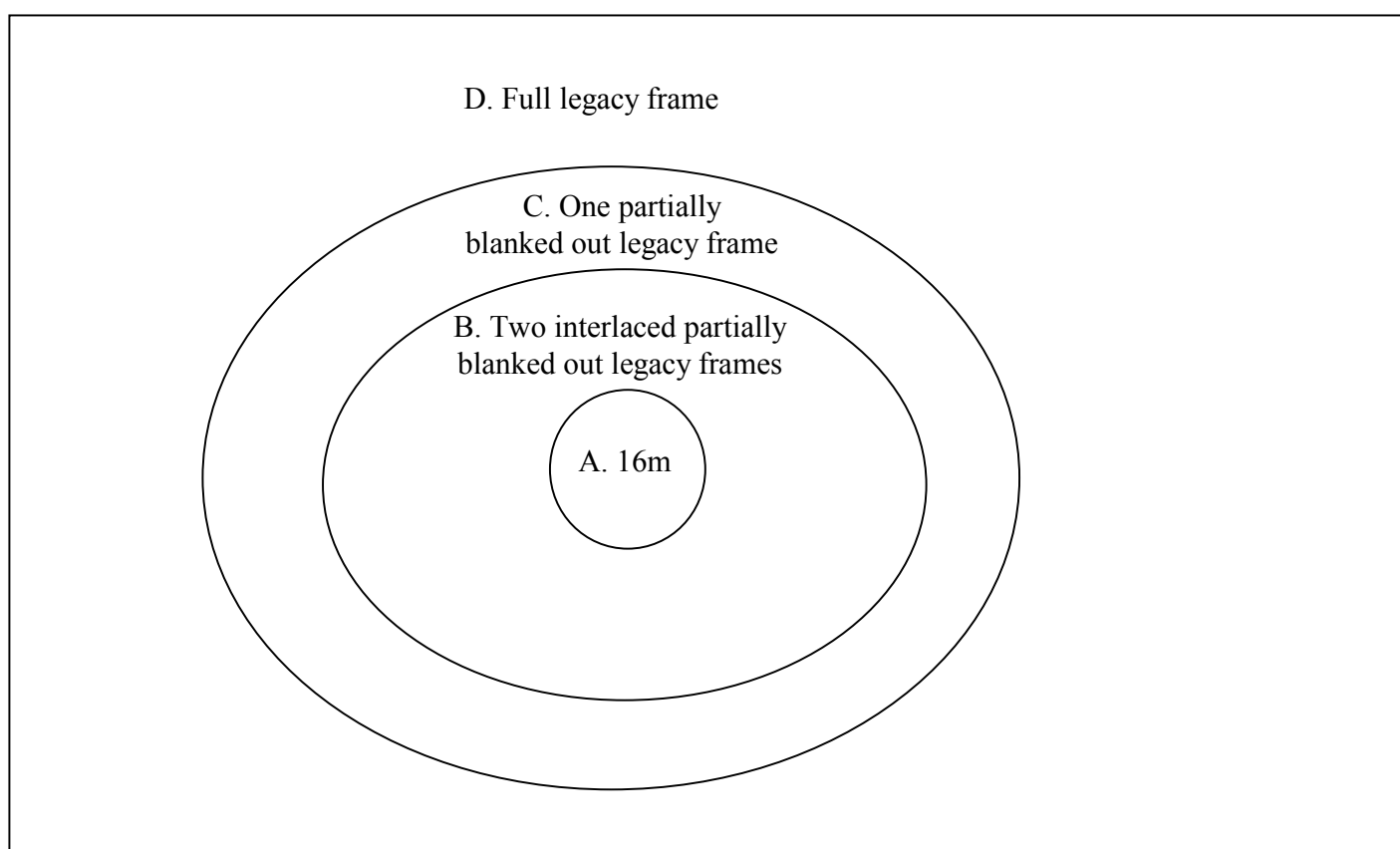

Figure 7 Schematic figure illustrating a network scenario with four regions A, B, C, and D. Region A and B is an urban suburban area with high traffic load. Region B is a surrounding rural area with low traffic load. Region D finally is the remaining network with varying characteristics. In region A (this may e.g. be a hot spot or a metropolitan area) the advanced air interface and the evolved frame structure has been deployed. In the surrounding urban suburban region B the technique with two interlaced partially blanked out legacy frames is used to eliminate interference problems without losing capacity. Further out in the surrounding rural area C the technique with one partially blanked out legacy frame is used to eliminate interference problems at the here acceptable cost in terms of capacity. In the outmost surrounding area D the full legacy frame is utilized without creating any interference problems.

### 3.5 Proposal

We propose that a section on Frame Structure is created in the Physical Layer Chapter in the System Description Document (SDD).

Additionally we propose that the frame structure section of the physical layer of SDD includes the evolved frame structure and the subsequent text in chapter 3, 3.1, 3.2 and 3.3 of this paper.

Finally we propose that the technique with the two interlaced partially blanked out legacy frames, and the text describing this technique in section 3.4, is included in the section on Solutions for Co-deployment and Co-existence in the SDD.

### References

- [1] IEEE 802.16m System Requirements IEEE 802.16m-07/002r4

- [2] WiMax Mobile System profile, Release 1.0
- [3] IEEE Std WirelessMAN-OFDMA-2005 and IEEE Std 802.16-2004/Cor1-2005 (Amendment and Corrigendum to IEEE Std 802.16-2004), “IEEE Standard for local and metropolitan area networks, Part 16: Air Interface for Fixed and Mobile Broadband Wireless Access Systems, Amendment 2: Physical and Medium Access Control Layers for Combined Fixed and Mobile Operation in License Bands,” Feb 28, 2006
- [4] An Evolved Frame Structure for IEEE 802.16m; C80216m-07\_235 / S80216m-07\_235
- [5] 802.16m frame structure to enable legacy support, technology evolution, and latency reduction; IEEE C802.16m-07\_263

## Appendix

The duration of an OFDM signal, when inserted in the transition gaps, can be reduced by only including a subset of evenly spaced subcarriers. This is explained by Figure 8 through Figure 10. In Figure 8, the subcarriers of an OFDMA symbol are illustrated for frequencies  $1/T_{\text{base}}=f_{\text{base}}, 2f_{\text{base}}, \dots$ , etc. up to  $6f_{\text{base}}$ , where  $T_{\text{base}}$  is the useful OFDM symbol duration and its reciprocal is called the base frequency.

As can be seen, the period for the frequency  $2f_{\text{base}}$  is half of that for  $f_{\text{base}}$ ; the period for the frequency  $3f_{\text{base}}$  is one third of that for  $f_{\text{base}}$ , etc. Hence, using, for example, every other subcarrier starting with  $2f_{\text{base}}$  will reduce the OFDMA symbol duration to half, while the orthogonality is still maintained over the time support of a  $1/2$  OFDM symbol duration. This is illustrated in Figure 9, which shows the  $1/2$  OFDM symbol duration based on integer multiples of  $2f_{\text{base}}$ . Following the same principle, using only every third subcarrier  $3f_{\text{base}}, 6f_{\text{base}}, 9f_{\text{base}}$  etc., will reduce the OFDM symbol duration to one third while still maintaining orthogonality. This is illustrated in Figure 10, which shows the OFDM signal with  $1/3$  OFDM symbol duration based on integer multiples of  $3f_{\text{base}}$ . As a general rule, using subcarriers whose frequencies are integer multiples of the  $N$ th harmonic of the base frequency,  $1/T_{\text{base}}$ , the symbol duration can be effectively shortened to  $1/N$  of the useful OFDM symbol duration, i.e.,  $T_{\text{base}}/N$ . At the receiver side, the same FFT module for demodulating other OFDMA symbols of  $T_{\text{base}}$  duration can be used by simply padding zeros outside the shortened  $T_{\text{base}}/N$  OFDM signal duration to perform detection only on the set of integer multiples of the  $N$ -th harmonic after FFT. At the transmitter side, the subcarriers outside of the set of integer multiples of the  $N$ -th harmonics are set to zero and FFT of the same size  $N_{\text{FFT}}$  is applied as a normal OFDM symbol. Before D/A conversion, only the first  $1/N$  of the  $N_{\text{FFT}}$  samples is converted from digital to analogue waveform for RF transmission and the remaining  $(N-1)/N$  samples are set to zeros. No new hardware is required to either send or detect this type of fractional symbol duration OFDM signal. The loss is in the number of subcarriers available for data modulation. With a  $1/N$  fractional use of the OFDM symbol, only  $1/N$  of the subcarriers can be used for data modulation.

As explained, the proposed fractional frequency-time space usage can accommodate non-integer-symbol-time transition gaps or the gaps between FDD frames. The advantage of this approach is that the same FFT circuit can be used at the transmitter, while the receiver can apply the same data demodulator and detector over a fractional symbol time window. The fractional-symbol-duration OFDM signal will have reduced peak rates and a reduced time interval to accumulate signal energy.

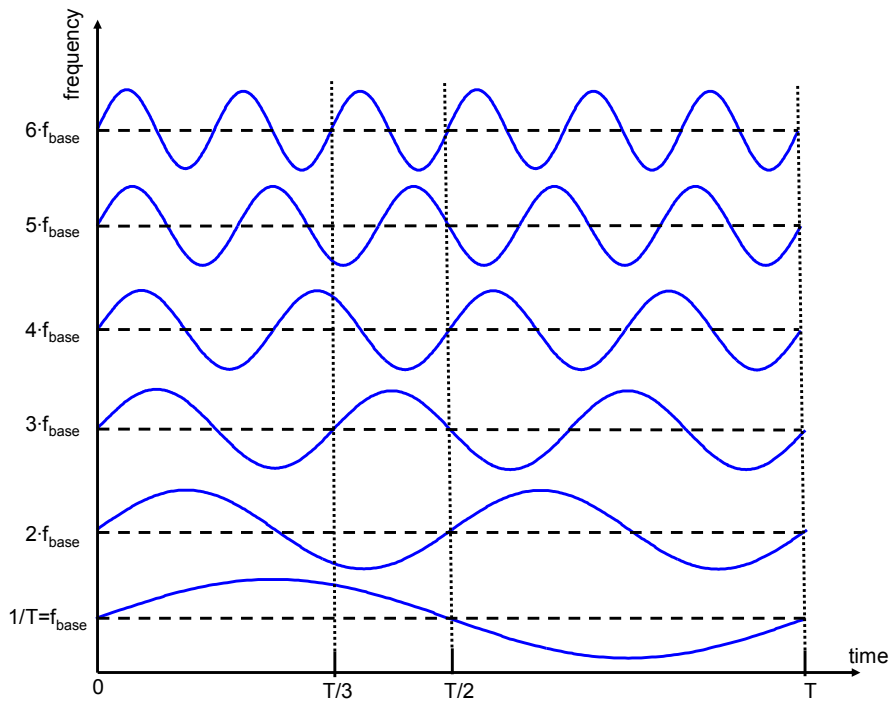

Figure 8: Relationship of Useful OFDM Symbol Time, Base Frequency, and Harmonics

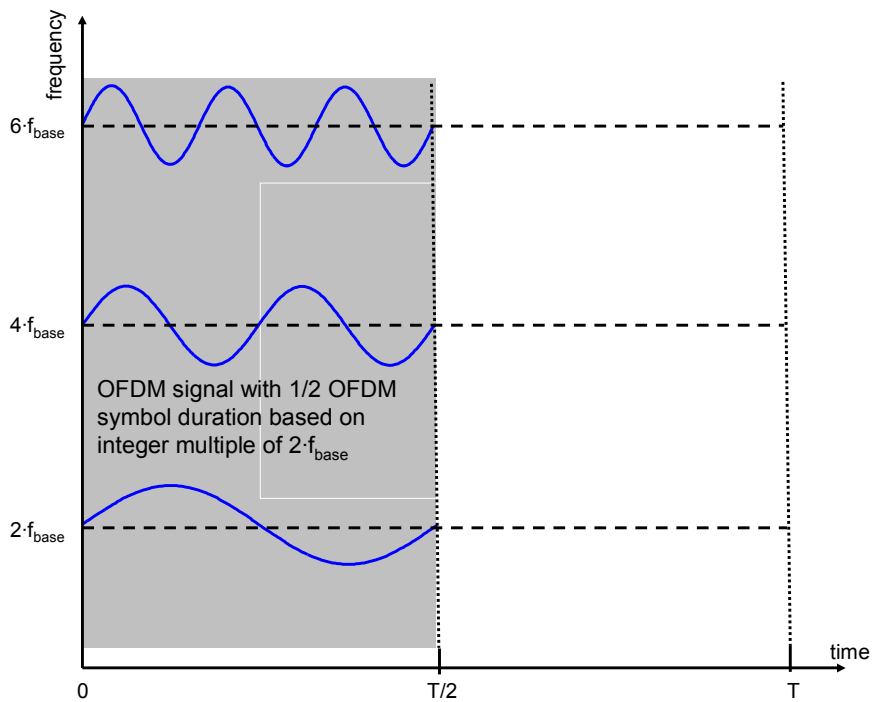

Figure 9: Even Integer Multiple of Base Frequency for Fractional Symbol Time OFDM Signal

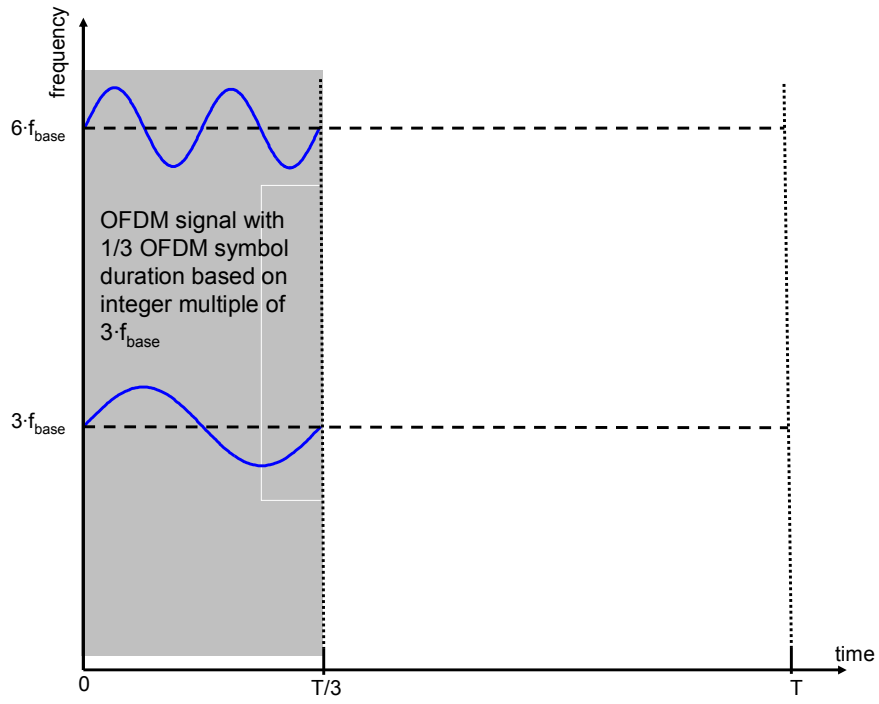

Figure 10: Integer Multiple of 3x Base Frequency for Fractional Symbol Time OFDM Signal

