

Project	IEEE 802.16 Broadband Wireless Access Working Group < http://ieee802.org/16 >	
Title	Proposed 802.16m Frame Structure Baseline Content Suitable for Use in the 802.16m SDD	
Date Submitted	2008-03-03	
Source(s)	Sassan Ahmadi Phil Barber Lei Wang Ron Murias	E-mail: sassan.ahmadi@intel.com pbarber@huawei.com lwang@nextwave.com ron@urias.ca * http://standards.ieee.org/faqs/affiliationFAQ.html >
Re:	IEEE 802.16m-08/006 (“Charter and Scope of TGm Rapporteur Groups”)	
Abstract	The contribution proposes the 802.16m frame structure baseline content suitable for use in the 802.16m SDD.	
Purpose	To be discussed and adopted by TGm for use in the 802.16m SDD.	
Notice	<i>This document does not represent the agreed views of the IEEE 802.16 Working Group or any of its subgroups.</i> It represents only the views of the participants listed in the “Source(s)” field above. It is offered as a basis for discussion. It is not binding on the contributor(s), who reserve(s) the right to add, amend or withdraw material contained herein.	
Release	The contributor grants a free, irrevocable license to the IEEE to incorporate material contained in this contribution, and any modifications thereof, in the creation of an IEEE Standards publication; to copyright in the IEEE’s name any IEEE Standards publication even though it may include portions of this contribution; and at the IEEE’s sole discretion to permit others to reproduce in whole or in part the resulting IEEE Standards publication. The contributor also acknowledges and accepts that this contribution may be made public by IEEE 802.16.	
Patent Policy	The contributor is familiar with the IEEE-SA Patent Policy and Procedures: < http://standards.ieee.org/guides/bylaws/sect6-7.html#6 > and < http://standards.ieee.org/guides/opman/sect6.html#6.3 >. Further information is located at < http://standards.ieee.org/board/pat/pat-material.html > and < http://standards.ieee.org/board/pat >.	

1 Proposed 802.16m Frame Structure Baseline Content suitable for use 2 in the 802.16m SDD

3 1 Introduction

4 This contribution proposes an initial text to be included in the 802.16m System
5 Description Document (SDD) under the frame structure section. The proposed text fairly
6 captures the membership inputs on frame structure [3] and provides for some key
7 attributes of IEEE 802.16m frame structure as required by the IEEE 802.16m system
8 requirement document [1], such as legacy support, while allowing for the introduction of
9 advanced transmission technology in advanced BSs and MSs, relay support,
10 coexistence with other radio access technologies, data and control plane latencies, etc.

11 2 Editor Notes

12 We propose to include the 802.16m frame structure specification as a subsection in the
13 “Physical Layer” section in the 802.16m SDD; i.e., Section 11 in the current 802.16m
14 SDD draft (IEEE 802.16m-08/003). The frame structure section provided includes
15 several subsections that we believe directly impact on the 802.16m frame structure;
16 e.g., duplex schemes, OFDMA parameters, etc.

17 In the proposed baseline content, there are duplicated section/subsection numbers,
18 Figure numbers, and Table numbers, which are meant to capture multiple proposals as
19 expressed in the combined spreadsheet [2], for the same topic.

20 Text in brackets indicates either an editorial note or a text proposal for which no
21 consensus has been established, but for which strong interest if not substantial
22 consensus was exhibited in the combined spreadsheet [2].

23 Text without brackets indicates a text proposal for a frame structure concept that
24 exhibited substantial consensus in the combined spreadsheet [2].

25 The following provides an overview of the proposed content given in section 3 of this
26 document:

27 11.1 Duplex Schemes

28

29 11.2 Downlink and Uplink Multiple Access Schemes

30

31 11.3. OFDMA Parameters

32 [Table 11.3-1: OFDMA parameters for IEEE 802.16m] → proposal-1

33 [Table 11.3-1: OFDMA parameters for IEEE 802.16m] → proposal-2

34

35 11.4 Frame Structure

36

37 11.4.1 Basic Frame Structure → proposal-1

38 11.4.1.1 Super-frame Header

1
2
3
4
5
6
7
8
9
10
11
12
13
14
15
16
17
18
19
20
21
22
23
24
25
26
27

11.4.1.2 Transmission Time Interval

11.4.1 Basic Frame Structure → proposal-2

11.4.2 Frame Structure Supporting Legacy Frames (proposal-1)

11.4.2 Frame Structure Supporting Legacy Frames (proposal-2)

11.4.2 Frame Structure Supporting Legacy Frames (proposal-3)

11.4.3 Frame Structure Supporting Legacy Frames with a Wider Channel for 802.16m (proposal-1)

11.4.3 Frame Structure Supporting Legacy Frames with a Wider Channel for 802.16m (proposal-2)

11.4.3 Frame Structure Supporting Legacy Frames with a Wider Channel for 802.16m (proposal-3)

11.4.4 Relay Supports in Frame Structure

11.4.5 Coexistence Supports in Frame Structure

11.4.5.1 Coexistence with E-UTRA (LTE)

11.4.5.2 Coexistence with UTRA LCR-TDD (TD-SCDMA)

11.5 Data Plane and Control Plane Access Latencies

11.5.1 Data Plane Access Latency

11.5.2 Control Plane Access Latency

3 Proposed 802.16m Frame Structure Baseline Content

11.1 Duplex Schemes

IEEE 802.16m supports TDD and FDD duplex schemes, including H-FDD MS operation, in accordance with the IEEE 802.16m system requirements document [1]. Unless otherwise specified, the frame structure attributes and baseband processing are common for all duplex schemes.

11.2 Downlink and Uplink Multiple Access Schemes

IEEE 802.16m uses OFDMA as the multiple access scheme in the downlink. [Determination of the UL multiple access method is pending the output of the Uplink Access Techniques Rapporteur Group and further action by 802.16m]

11.3 OFDMA Parameters

The OFDMA parameters for the IEEE 802.16m are specified as follows:

Nominal Channel Bandwidth (MHz)		5	7	8.75	10	20
Over-sampling Factor		28/25	8/7	8/7	28/25	28/25
Sampling Frequency (MHz)		5.6	8	10	11.2	22.4
FFT Size		512	1024	1024	1024	2048
Sub-Carrier Spacing (kHz)		10.94	7.81	9.77	10.94	10.94
Tu (μ s)		91.4	128	102.4	91.4	91.4
Cyclic Prefix (CP)	Ts (μ s)	Number of OFDM Symbols per Frame				Idle Time (μ s)
Tg=1/8 Tu	91.4 + 11.42=102.82 (for 5, 10, 20 MHz)	48 (for 5, 10, 20 MHz)				62.86
	128+16=144 (for 7 MHz)	34 (for 7 MHz)				104
	102.4+12.8=115.2 (for 8.75 MHz)	43 (for 8.75 MHz)				46.40
Tg=1/16 Tu	91.4 + 5.71 = 97.11 (for 5, 10, 20 MHz)	51 (for 5, 10, 20 MHz)				47.39

Table 11.3-1: OFDMA parameters for IEEE 802.16m

11.4 Frame structure

11.4.1 Basic Frame structure

The IEEE 802.16m basic frame structure is illustrated in Figure 11.4-1. Each 20 ms super-frame is divided into four equally-sized 5ms radio frames. When using the same

1 OFDMA parameters as the reference system with the channel size of 5 MHz, 10 MHz,
 2 or 20 MHz, each 5 ms radio frame further consists of eight sub-frames. Each sub-frame
 3 can be assigned for either downlink or uplink transmission depending on the duplexing
 4 scheme. There are two types of sub-frames: 1) the regular sub-frames which consist of
 5 six OFDMA symbols and 2) the irregular sub-frames that consist of five or less OFDMA
 6 symbols. The BS may choose to allocate and announce sleeping gaps in the sequence
 7 of frames, typically in a periodic pattern. The Frame Number counter is incremented as
 8 if frames were transmitted in a non-interrupted sequence. In addition, Hyper-Frame is
 9 defined as the repeated time interval defining location in which longer-term system
 10 information occurs, e.g., the channel descriptors, neighbor lists, security information,
 11 etc.

12
 13 The basic frame structure is applied to FDD and TDD duplexing schemes, including H-
 14 FDD MS operation. The number of switching points in each radio frame in TDD systems
 15 is between two to four, where a switching point is defined as a change of directionality,
 16 i.e., from DL to UL or from UL to DL. There shall be only two switching points in each
 17 TDD radio frame when supporting legacy systems.

18
 19

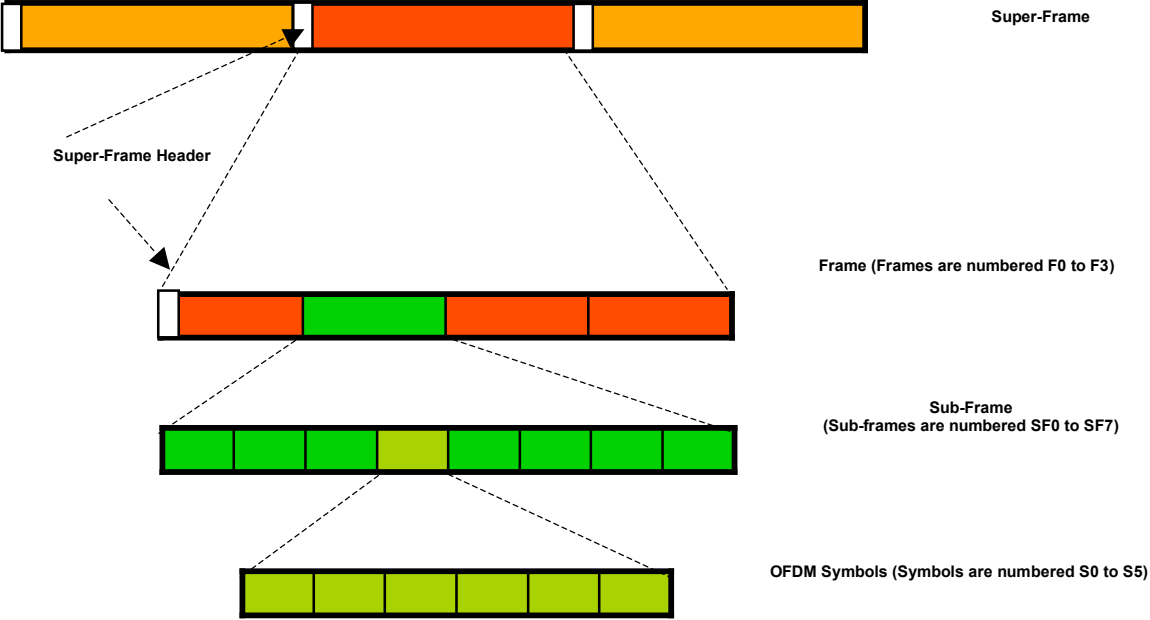

20
 21
 22 Figure 11.4-1: Basic frame structure

23
 24 Figure 11.4.-2 illustrates an example TDD frame structure with DL to UL ratio of 5:3.
 25 Assuming OFDMA symbol duration of 102.82 us and a CP length of 1/8 T_u , the length
 26 of regular and irregular sub-frames are 0.617 ms and 0.514 ms, respectively. Other
 27 numerologies may result in different number of sub-frames per frame and symbols
 28 within the sub-frames. Figure 11.4-3 shows the frame structure in FDD mode.

29

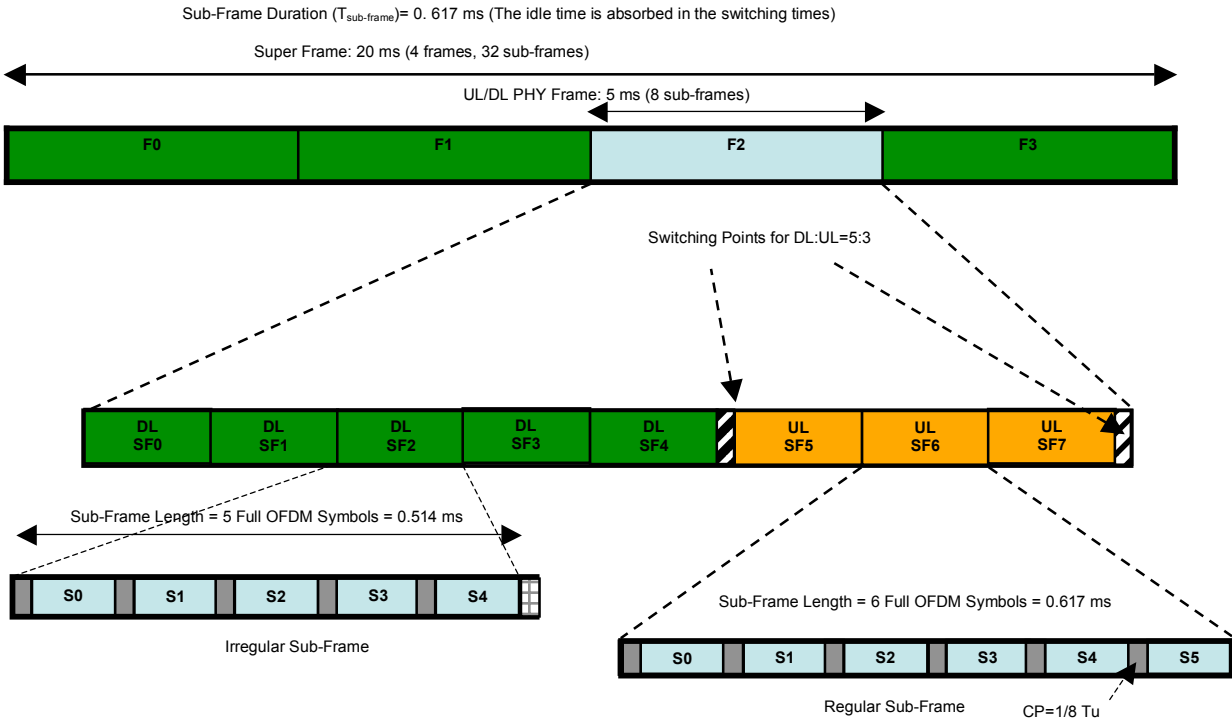

1
2
3
4

Figure 11.4-2: Regular and irregular sub-frames in TDD duplex scheme (CP=1/8 T_u)

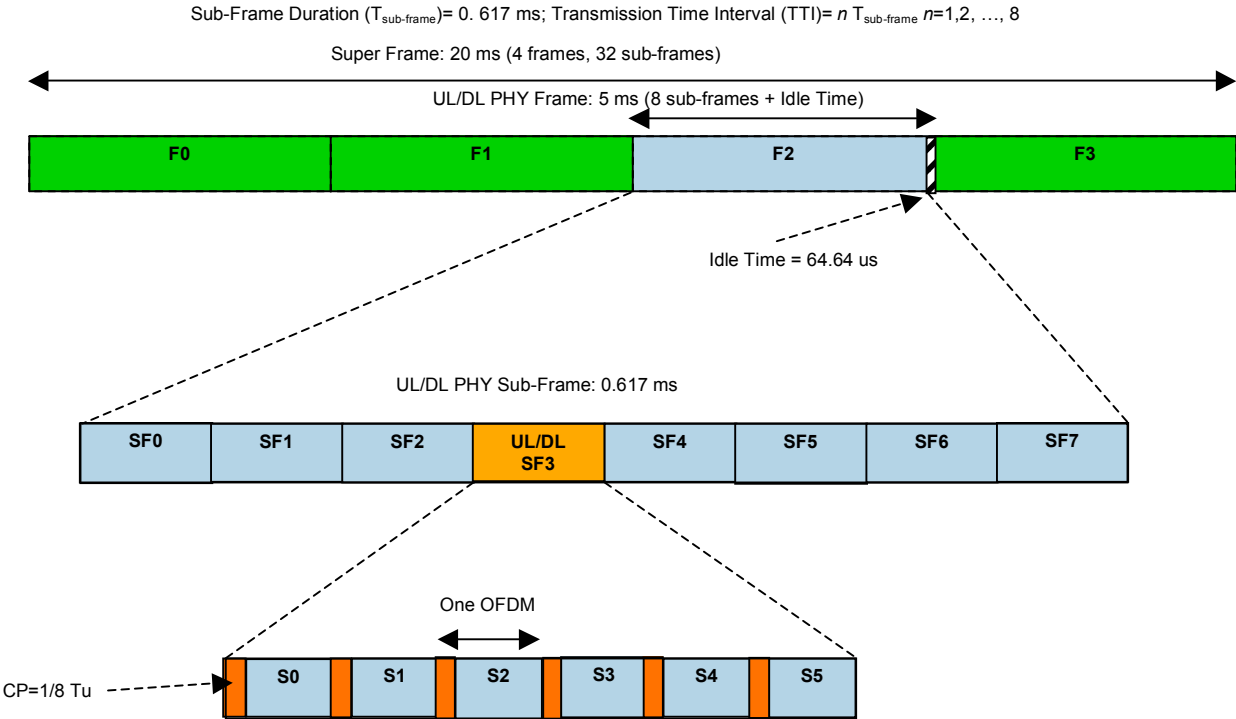

5
6
7
8

Figure 11.4-3: Frame structure in FDD duplex scheme (regular sub-frames) (CP=1/8 T_u)

1 The H-FDD frame structure from the point of view of the mobile station is similar to the
2 TDD frame structure; however, the DL and UL transmissions occur in two separate
3 frequency bands. The transmission gaps between DL and UL (and vice versa) are
4 required to allow switching the TX and RX circuitry.

5
6 To ensure efficient use of the radio resources when operating with H-FDD mobile
7 stations in an FDD network, the mobile stations within the coverage area of the BS
8 should be grouped into two complementary groups whose downlink and uplink
9 transmissions are not concurrent (an example is shown in Figure x-3). The frame
10 structure from the point of view of the BS and the full FDD mobile stations is not
11 affected by the H-FDD characteristics of some mobile stations and is identical to the
12 FDD frame structure. However, the frame structure from the point of view of the H-FDD
13 mobile stations is different and DL and UL transmissions do not occur simultaneously.
14 Nevertheless the downlink and uplink transmission frequencies are different. Since the
15 beginning of the DL radio frame and super-frame may contain broadcast information
16 (i.e., synchronization channel or preamble as well as super-frame header containing the
17 broadcast channel); this is marked in red in Figure x-3, the H-FDD mobile station groups
18 should not have any uplink transmissions scheduled in the first sub-frame of each
19 frame. The complementary grouping and scheduling scheme described here can
20 ensure efficient utilization of the radio resources. Also note that the H-FDD mobile
21 stations require a switching time between any DL to UL or UL to DL transition.

Frame Structure from the BS point of view (full FDD)

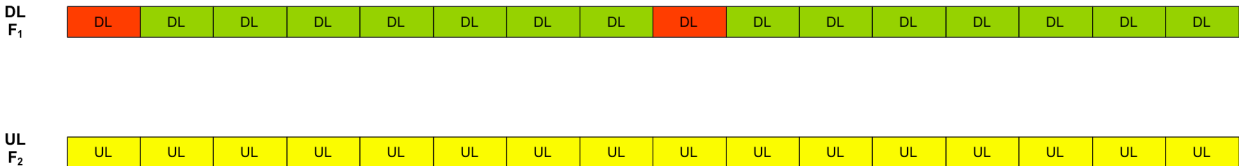

Frame Structure from the Group I MS point of view (H-FDD)

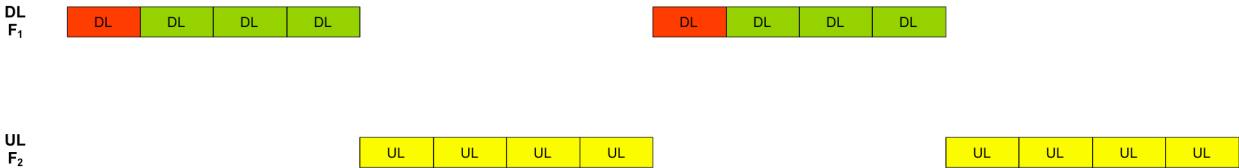

Frame Structure from the Group II MS point of view (H-FDD)

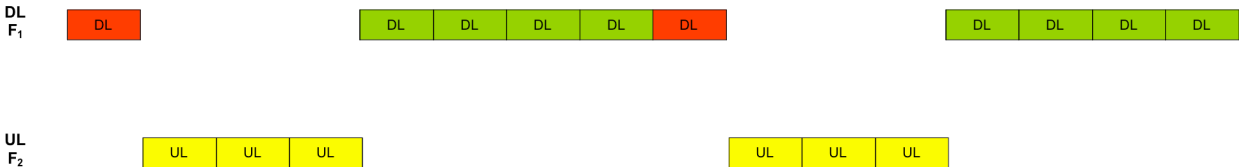

Figure 11.4-3: Example of Complementary grouping and scheduling of H-FDD mobile stations

1
2
3
4
5
6
7
8
9
10
11
12
13
14
15
16
17
18
19
20
21
22
23
24
25
26
27

11.4.1.1 Super-frame Header

As shown in Figure 11.4-1, each super-frame shall begin with a DL sub frame that contains a super-frame header.

11.4.1.2 Transmission Time Interval

The transmission time interval is the minimum transmission time of physical layer data units over the radio air-interface and is equal to an integer number of sub-frames (default one sub-frame).

11.4.2 Frame Structure Supporting Legacy Frames

The legacy and 802.16m frames are offset by a fixed number of sub-frames to accommodate new features such as new synchronization channel (preamble), broadcast channel (system configuration information), and control channels, as shown in Figure 11.4-3 (proposal-1). The FRAME_OFFSET shown in 11.4-3 (proposal-1) is for illustration. It is an offset between the start of the legacy frame and the start of the new frame. In the case of coexistence with legacy systems, two switching points may be selected in each TDD radio frame.

For UL transmissions both TDM and FDM approaches should be supported for multiplexing of legacy and 16m mobiles.

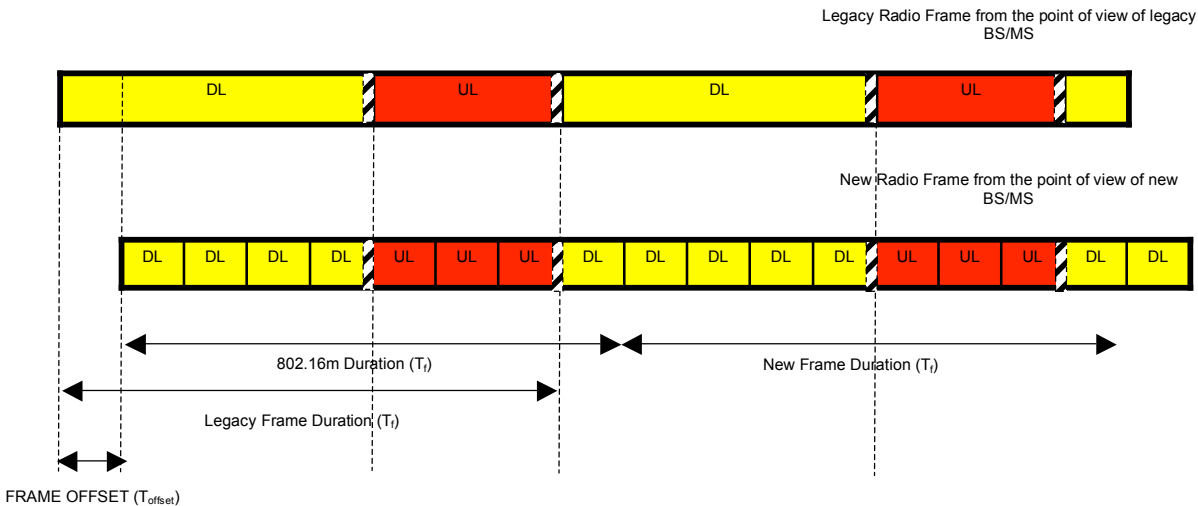

Figure 11.4-3: Relative position of the new and legacy radio frames (example TDD duplex scheme) → proposal-1

28
29
30
31
32
33

11.4.3 Frame Structure Supporting Legacy Frames with a Wider Channel for 802.16m

11.4.4 The Concept of Time Zones

The concept of time zones is introduced that is equally applied to TDD and FDD systems. The new and legacy time zones are time-multiplexed (TDM) across time domain for the downlink. For UL transmissions both TDM and FDM approaches should be supported for multiplexing of legacy and new terminals. Note that DL/UL traffic for the new MS can be scheduled in both zones whereas the DL/UL traffic for the legacy MS can only be scheduled in the legacy zones.

In the absence of any legacy system, the legacy zones will disappear and the entire frame will be allocated to the new zones and thereby new systems.

11.4.4.1 Time Zones in TDD

As was mentioned earlier, the concept of time zones applies to TDD mode (see Figure x-6), as well. The following constraints apply:

In a mixed deployment, the allocation of time zones in the TDD duplex mode shall be as shown in Figure x-6. The duration of the zones may vary. Every frame shall start with a preamble and the MAP followed by legacy DL zone since legacy terminals/relays expect 802.16e zones in this region. In the case of coexistence, the UL portion shall start with legacy UL zone since legacy BS/terminals/relays expect 802.16e UL control information be sent in this region. In a green-field deployment, the legacy zones can be removed.

Switching points should be synchronized across network to reduce inter-cell interference.

The switching points would require use of idle symbols to accommodate the gaps. In case of TDD operation with the generic frame structure, the last symbol in the slot immediately preceding a downlink-to-uplink/uplink-to-downlink switching point may be reserved for guard time and consequently not transmitted.

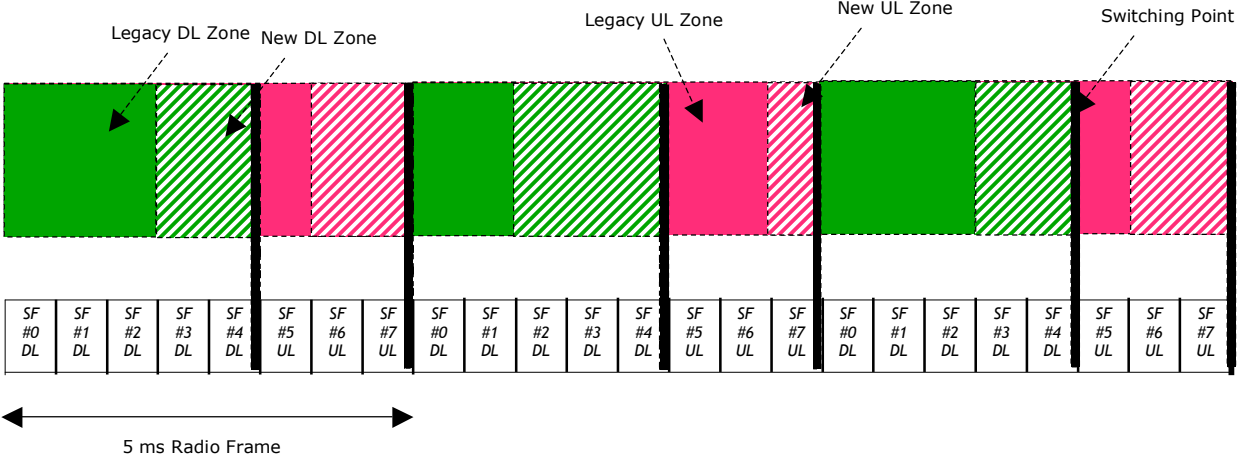

Figure 11.4-5: Time zones in TDD mode

1
2
3
4
5
6
7
8
9
10
11
12
13
14
15
16
17
18
19
20
21
22
23
24
25
26
27
28
29
30
31

11.4.4 Relay Support in Frame Structure

11.4.5 Coexistence Supports in Frame Structure

[Editor note: the following text has been generated based on minority opinion and the TBD responses from a large number of members to latency attributes of the frame structure in the Excel Sheet [2] and the necessity to demonstrate the frame structure compliance with the IEEE 802.16m SRD [1]. The content of the following tables will be updated based on the ultimate decisions that will be made in the group on the frame structure parameters.]

A. Data Plane and Control Plane Access Latencies

[In order to justify the choice of parameters for the proposed frame structure, it is imperative to demonstrate that the frame structure and associated parameters satisfy the IEEE 802.16m system requirements. In the following sections, the break down of the data and control planes access latencies is provided for the reference and the IEEE 802.16m systems.

A.1 Data Plane Access Latency

The break down of the components of data plane access latency is shown in Table 11.5-1. The access latency with 30% frame error rate over the airlink is 4.67 ms which is less than 10 ms limit specified by the IEEE 802.16m SRD.

Step	Description	IEEE 802.16e Value	IEEE 802.16m Value
0	MS wakeup time	Implementation Dependent	Implementation Dependent
1	MS Processing Delay	2.5 ms	1.23 ms
2	Frame Alignment	2.5 ms	0.31 ms
3	TTI for UL DATA PACKET (Piggy back scheduling information)	5 ms	0.617 ms
4	H-ARQ Retransmission (FER = 30%)	0.3*20 ms	0.3* 4.3 ms
5	BS Processing Delay	2.5 ms	1.23 ms
6	R6 Transfer delay	T_{R6}	T_{R6}
7	ASN-GW Processing delay	T_{ASN_GW}	T_{ASN_GW}
	Total one way access delay	$18.50 \text{ ms} + T_{ASN_GW} + T_{R6}$	$4.67 \text{ ms} + T_{ASN_GW} + T_{R6}$

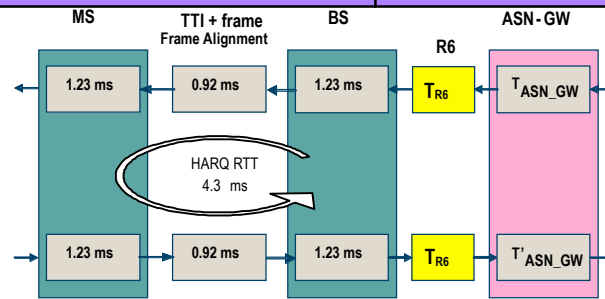

Table 11.5-1: Data plane access latency. The above processing time is FFS.

A.2 Control Plane Access Latency

The break down of system entry procedure from DL scanning and synchronization to the point where the radio resource control (RRC) connection is established is shown in Table 11.5-2. Note that the use of super-frame header, that encompasses the system configuration information, would significantly reduce the time spent in step 1. Also, since the probability of error required for transmission of some of the MAC control messages is typically 10^{-3} , H-ARQ is used to ensure more reliability. The use of shorter TTI and faster transmissions would enable shorter H-ARQ retransmission, consequently reducing the total time for IDLE_STATE to ACTIVE_STATE transition.

In addition, we assume that the base station, relay station, or mobile station processing time is approximately $2 * TTI = 1.23 \text{ ms}$, that further reduces the total delay budget. It is shown that the IDLE_STATE to ACTIVE_STATE transition time of less than 80 ms is achievable through the use of proposed frame structure which is less the 100 ms value specified by the SRD.

It must be noted that some of the radio resource control and management messages require probability errors in the order of 10^{-6} ; ARQ is used in conjunction with H-ARQ to achieve higher transmission reliability.

Step	Description	IEEE 802.16e Value	IEEE 802.16m Value
0	MS wakeup time	Implementation dependent	Implementation dependent
1	DL scanning and synchronization + DL MAP acquisition + DCD/UCD acquisition	> 300 ms (Assuming 0.5 s DCD/UCD interval)	20 ms
2	Random Access Procedure (UL CDMA Code + BS Processing + DL CDMA_ALLOC_IE)	> 15 ms	< 5 ms
3	Initial Ranging (RNG-REQ + BS Processing + RNG-RSP)	> 15 ms (0.3*20 ms for H-ARQ ReTX)	< 5 ms (0.3* 4.3 ms for H-ARQ)
4	Capability Negotiation (SBC-REQ + BS Processing + SBC-RSP) + H-ARQ Retransmission @ 30%	> 15 ms (0.3*20 ms for H-ARQ ReTX)	< 5 ms (0.3* 4.3 ms for H-ARQ ReTX)
5	Authorization and Authentication/Key Exchange (PKM-REQ + BS Processing + PKM-RSP + ...) +H-ARQ Retransmission @30%	> 15 ms (0.3*20 ms for H-ARQ ReTX)	< 5 ms (0.3* 4.3 ms for H-ARQ ReTX)
6	Registration (REG-REQ + BS/ASN-GW Processing + REG-RSP) + H-ARQ Retransmission @30%	> 15 ms (0.3*20 ms for H-ARQ ReTX)	< 5 ms (0.3* 4.3 ms for H-ARQ ReTX)
7	RRC Connection Establishment (DSA-REQ + BS Processing + DSA-RSP + DSA-ACK) + H-ARQ Retransmission @30%	> 15 ms (0.3*20 ms for H-ARQ ReTX)	< 5 ms (0.3* 4.3 ms for H-ARQ ReTX)
	Total C-plane connection establishment Delay	> 80 ms	< 30 ms
	Total IDLE_STATE -> ACTIVE_STATE Delay	> 380 ms	< 80 ms

1
2
3
4
5
6

Table 11.5-2: Control plane access latency. The above processing time is FFS.

4 References

- [1] IEEE 802.16m-07/002r4 (“IEEE 802.16m System Requirements”)
- [2] IEEE C802.16m-08/096r10
- [3] See the list of frame structure contributions in the January 2008 IEEE 802.16m upload directory.