

Project	IEEE 802.16 Broadband Wireless Access Working Group < http://ieee802.org/16 >
Title	Layer Mapping for Downlink Single-User MIMO in IEEE 802.16m
Date Submitted	2008-05-09
Source(s)	Chung-Lien Ho, Ren-Jr Chen, Chien-Min Lee, E-mail: clho@itri.org.tw Chang-Lung Hsiao, Yan-Xiu Zheng, Richard Li, ITRI Wern-Ho Sheen, NCTU/ITRI
Re:	IEEE 802.16m-08/016r1: Call for Contributions on Project 802.16m System Description Document (SDD). Target topic: "Downlink MIMO schemes".
Abstract	Layer mapping issues in downlink single-user MIMO are discussed and recommended to IEEE 802.16m system for further evaluation.
Purpose	For 802.16m discussion and adoption
Notice	<i>This document does not represent the agreed views of the IEEE 802.16 Working Group or any of its subgroups. It represents only the views of the participants listed in the "Source(s)" field above. It is offered as a basis for discussion. It is not binding on the contributor(s), who reserve(s) the right to add, amend or withdraw material contained herein.</i>
Release	The contributor grants a free, irrevocable license to the IEEE to incorporate material contained in this contribution, and any modifications thereof, in the creation of an IEEE Standards publication; to copyright in the IEEE's name any IEEE Standards publication even though it may include portions of this contribution; and at the IEEE's sole discretion to permit others to reproduce in whole or in part the resulting IEEE Standards publication. The contributor also acknowledges and accepts that this contribution may be made public by IEEE 802.16.
Patent Policy	The contributor is familiar with the IEEE-SA Patent Policy and Procedures: < http://standards.ieee.org/guides/bylaws/sect6-7.html#6 > and < http://standards.ieee.org/guides/opman/sect6.html#6.3 >. Further information is located at < http://standards.ieee.org/board/pat/pat-material.html > and < http://standards.ieee.org/board/pat >.

Transmission Framework

- General transmission structure for downlink (DL) single-user MIMO (SU-MIMO)

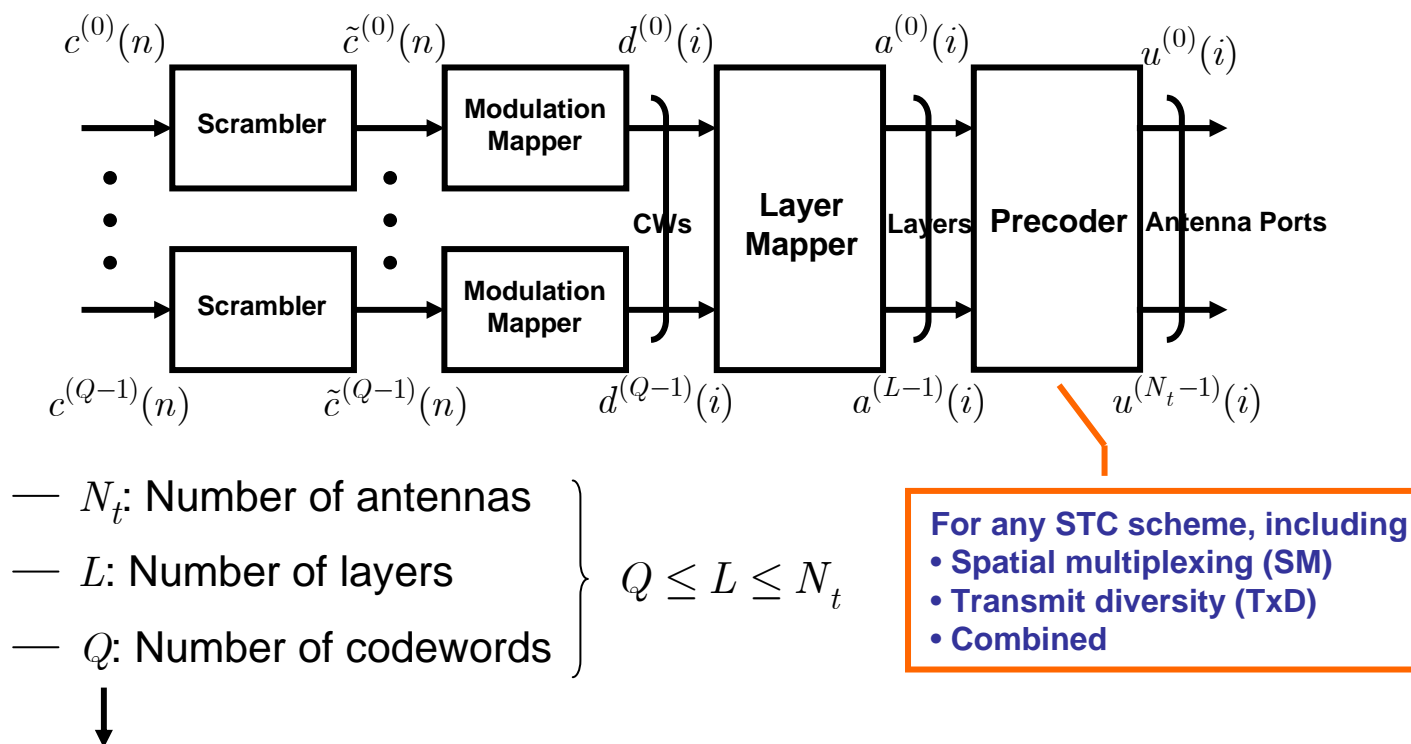

Now is FFS and needs to be determined for further evaluation!

Single Codeword (SCW) vs. Multiple Codeword (MCW)

- SCW
 - Data block is coded and modulated into single coded block ($Q = 1$)
 - When rank of channel $r = 1$, SCW is used
- MCW
 - Data block is segmented, coded and modulated separately into multiple coded sub-blocks ($Q > 1$)
- For SU-MIMO, maximum number of CWs per data block (or that can be received by UE) is determined by
 - Number of modulation & coding sets (MCSs)
 - Channel quality indicator (CQI) feedback overhead

Layer Mapping

- In spatial multiplexing (or combined schemes), number of layers for MIMO channel is determined by
 - Number of transmit and receive antennas
 - Channel state information (CSI), including rank of channel
 - CQI feedback
- In transmit diversity, number of layers is equal to number of transmit antennas
- Number of CWs is constrained by number of layers and controlled through layering unit

Layer Mapping

- CW-to-layer mapping for spatial multiplexing
 - SCW (Example: $Q = 1, L = 1, 2, 3, 4$)

(a) Rank 1: CW 1 to Layer 1

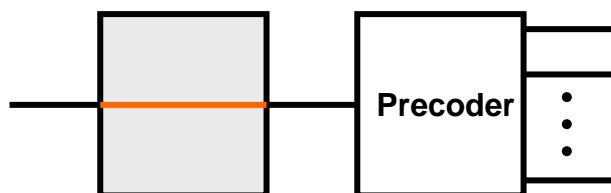

(b) Rank 2: CW 1 to Layers 1 & 2

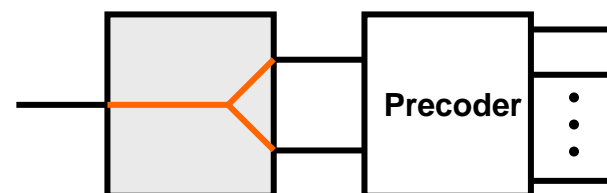

(c) Rank 3: CW 1 to Layers 1, 2 & 3

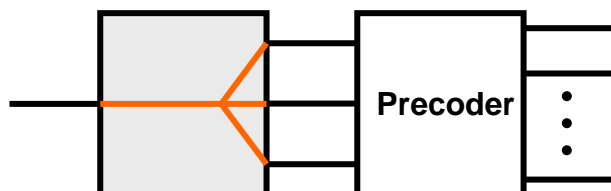

(d) Rank 4: CW 1 to Layers 1 to 4

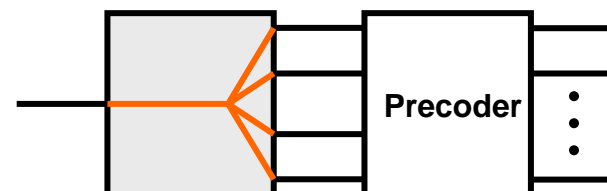

Layer Mapping

- CW-to-layer mapping for spatial multiplexing
 - MCW (Example: $Q = 2, L = 2, 3, 4$)

(e) Rank 2: CW 1 to Layer 1
CW 2 to Layer 2

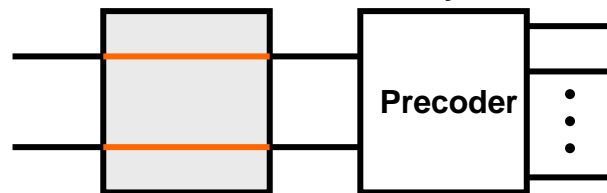

(f) Rank 3: CW 1 to Layer 1
CW 2 to Layers 2 & 3

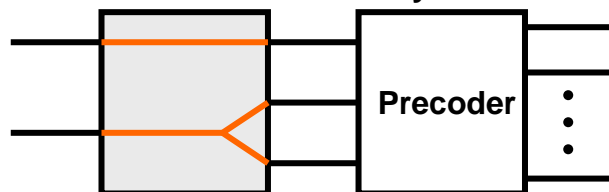

(g) Rank 4: CW 1 to Layer 1 & 2
CW 2 to Layers 3 & 4

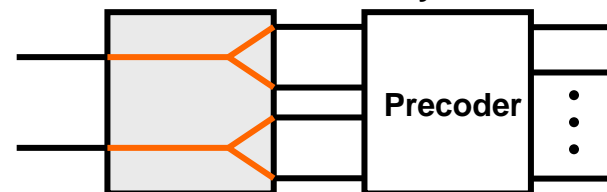

Conclusion

- Crucial parameters at transmitter need to be determined for DL SU-MIMO
 - Maximum antenna configuration
 - Maximum number of layers (independent streams) for spatial multiplexing
 - Maximum number of CWs
- Re-evaluate CW-to-layer mapping for spatial multiplexing in DL SU-MIMO

Text Proposal

- ***Insert the following subsection into Physical Layer of SDD (IEEE C802.16m-08/003):***

----- *Start of Text Proposal* -----

11. Physical Layer

11.x.y.z Codeword-to-Layer Mapping Scheme

TBD

----- *End of Text Proposal* -----