

Project	IEEE 802.16 Broadband Wireless Access Working Group < http://ieee802.org/16 >	
Title	Mobility Zone for Uplink MIMO	
Date Submitted	2008-07-15	
Source(s)	Yang-Han Lee, Yih-Guang Jan, Ming-Hsueh Chuang, Hsien-Wei Tseng, Ting-Chien Wang, Po-Jung Lin, Tamkang University (TKU)	E-mail: yhlee@ee.tku.edu.tw
	Kanchei (Ken) Loa, Chih-Wei Su, Yung-Ting Lee, Hua-Chiang Yin, Youn-Tai Lee Institute for Information Industry (III)	E-mail: loa@nmi.iii.org.tw
	Shiann-Tsong Sheu National Central University (NCU)	E-mail: stsheu@ce.ncu.edu.tw
	Whai-En Chen National Ilan University (NIU)	E-mail: wechen@niu.edu.tw
Re:	IEEE 802.16m-08/024: Call for Contributions on Project 802.16m System Description Document (SDD). Target topic: "Uplink MIMO".	
Abstract	This contribution provides the pilot for UL MIMO operation	
Purpose	To be discussed and adopted by TGM for the 802.16m SDD	
Notice	This document does not represent the agreed views of the IEEE 802.16 Working Group or any of its subgroups. It represents only the views of the participants listed in the "Source(s)" field above. It is offered as a basis for discussion. It is not binding on the contributor(s), who reserve(s) the right to add, amend or withdraw material contained herein.	
Release	The contributor grants a free, irrevocable license to the IEEE to incorporate material contained in this contribution, and any modifications thereof, in the creation of an IEEE Standards publication; to copyright in the IEEE's name any IEEE Standards publication even though it may include portions of this contribution; and at the IEEE's sole discretion to permit others to reproduce in whole or in part the resulting IEEE Standards publication. The contributor also acknowledges and accepts that this contribution may be made public by IEEE 802.16.	
Patent Policy	The contributor is familiar with the IEEE-SA Patent Policy and Procedures: < http://standards.ieee.org/guides/bylaws/sect6-7.html#6 > and < http://standards.ieee.org/guides/opman/sect6.html#6.3 >. Further information is located at < http://standards.ieee.org/board/pat/pat-material.html > and < http://standards.ieee.org/board/pat >.	

Mobility Zone for Uplink MIMO

Yang-Han Lee, Yih-Guang Jan, Ming-Hsueh Chuang, Hsien-Wei Tseng, Ting-Chien Wang, Po-Jung Lin

Tamkang University (TKU)

Kanchei (Ken) Loa, Chih-Wei Su, Yung-Ting Lee, Hua-Chiang Yin, Youn-Tai Lee

Institute for Information Industry (III)

Shiann-Tsong Sheu

National Central University (NCU)

Whai-En Chen

National Ilan University (NIU)

1. Introduction

Based on the Mobility-Zone (MB-Zone) structure as proposed in C802.16m-08_444r2, we implement the MB-Zone design and simulation by using certain pilot patterns proposed by some companies. In the MB-Zone design the original structure of the pilot patterns is maintained but its number of pilot increases when the mobile speed increases.

2. Basic Simulation Parameters

The Basic simulation parameters are listed in Table 1.

Parameter	Baseline
Carrier Frequency	2.5 GHz
System BW	10 MHz
Channel Model	Veh A. with 3km/hr, 120km/hr and 350km/hr
Channel Coding	No Use
Antenna Configuration	2x2 MIMO
Modulation and Coding	QPSK
Resource Allocation	1. 9 symbols * 4 subcarriers 2. 9 symbols * 9 subcarriers 3. 18 symbols * 6 subcarriers 4. 18 symbols * 12 subcarriers 5. 18 symbols * 18 subcarriers
Pilot Tone Boost	2.5dB over data tone
Channel Estimation	MMSE

Table 1 Simulation parameters

2.1 Different Speed Zone Structure: The Different Speed Zone as MB Zone proposed in C802.16m-08_442r2 has the structure as shown in Fig.1 and its simulation result is shown in Fig. 2. In the simulation we also include the results when the pilot patterns implemented for 3 km/hr and 120 km/hr are based on the pilot structure for high mobility situation, their results are identified by prefixing with HM, e.g. HM@3km/hr for MS with 3 km/hr MS. It reveals from the simulation result that when the mobile speed is low we can use few pilots to get the same results as obtained by using dense pilots to increase the number of data placement. If we use the pilot structure for high mobility to design the pilot pattern for low mobility situation some extra SNR gain around 1dB can be obtained.

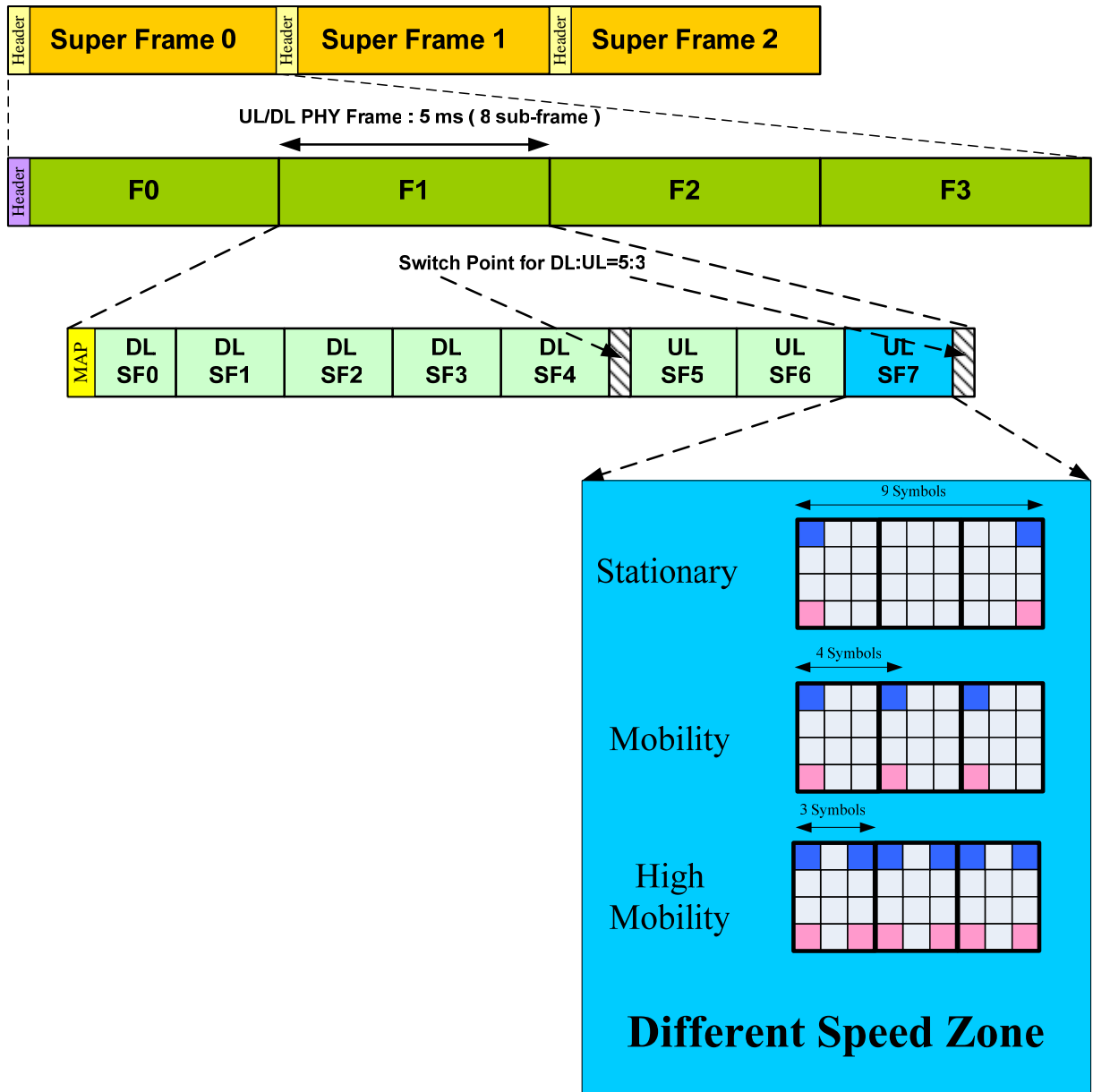

Fig. 1 Different Speed Zones

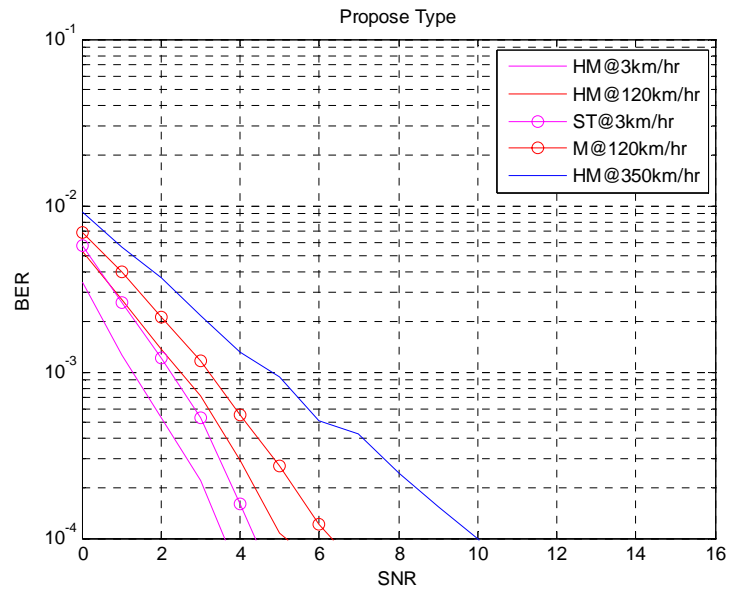

Fig .2 Simulation Result for Proposed Uplink Pilot Format

2. Simulation of Various Types of Pilot Patterns

2.1 Type A RB

As shown in Fig. 3 is an illustration of Type A Resource Block (RB) and at various mobile speeds they have the Different Speed Zones structure shown in Fig. 4. The simulation results when the mobile speeds are at 3 km/hr, 120 km/hr and 350 km/hr are shown in Fig. 5. In the simulation we also include the results when the pilot patterns implemented for 3 km/hr and 120 km/hr are based on the pilot structure for high mobility situation, their results are identified by prefixing with HM, e.g. HM@3km/hr for MS with 3 km/hr MS. When the mobile speed is low we can use few pilots to attain the same performance result.

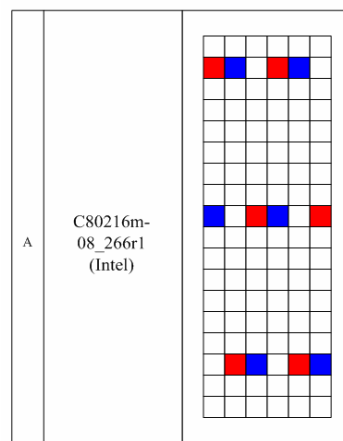

Fig. 3 Type A RB

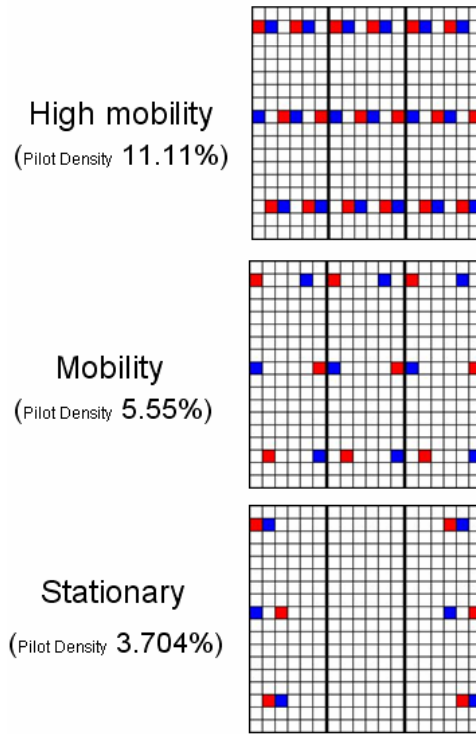

Fig. 4 Type A Different Speed Zones

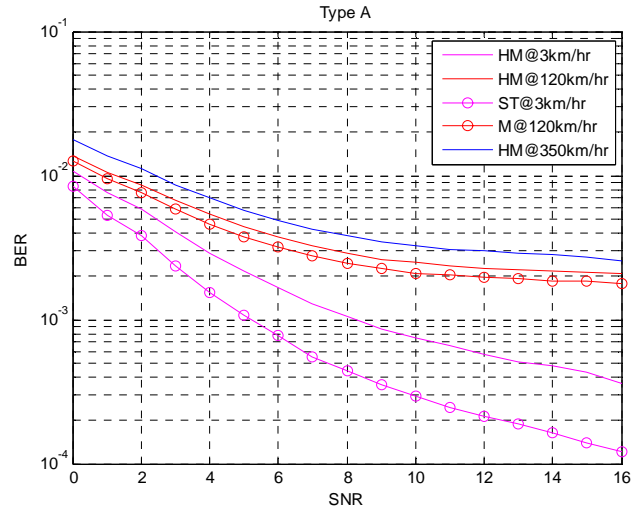

Fig. 5 Simulation Result for Type A Uplink Pilot Format

2.2 Type B RB

As shown in Fig. 6 is a Type B Resource Block, its Different Speed Zones has the structure as shown in Fig. 7. The simulation results at mobile speeds of 3 km/hr, 120 km/hr and 350 km/hr are shown in Fig. 8. In the simulation we also include the results when the pilot patterns implemented for 3 km/hr and 120 km/hr are based on the pilot structure for high mobility situation, their results are identified by prefixing with HM, e.g.

HM@3km/hr for MS with 3 km/hr MS. As shown in the simulation results it still can get the same system performance by using few pilots when the mobile speed is low.

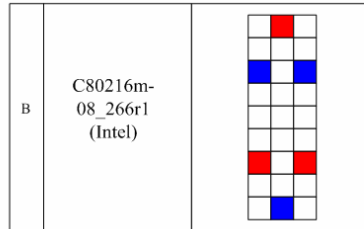

Fig. 6 Type B RB

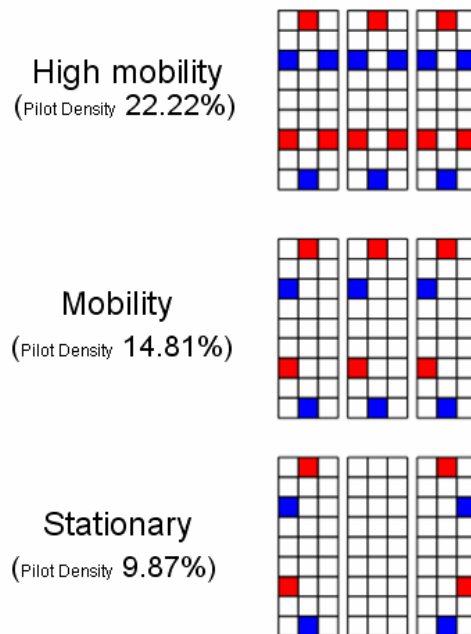

Fig. 7 Type B Different Speed Zones

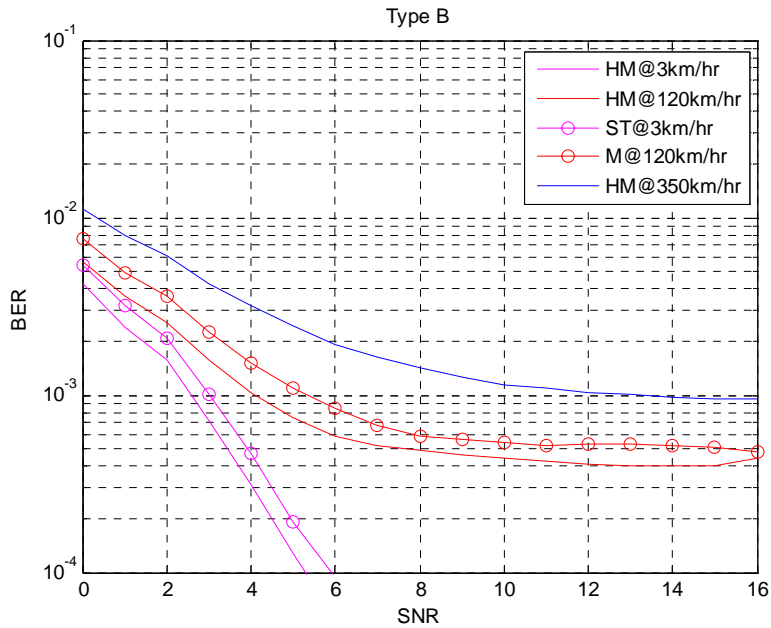

Fig. 8 Simulation Result for Type B Uplink Pilot Format

2.3 Type C RB

As shown in Fig. 9 is a Type C Resource Block, its Different Speed Zones has the structure as shown in Fig. 10. The simulation results at mobile speeds of 3 km/hr, 120 km/hr and 350 km/hr are shown in Fig. 11. In the simulation we also include the results when the pilot patterns implemented for 3 km/hr and 120 km/hr are based on the pilot structure for high mobility situation, their results are identified by prefixing with HM, e.g. HM@3km/hr for MS with 3 km/hr MS. As shown in the simulation results it still can get the same system performance by using few pilots when the mobile speed is low.

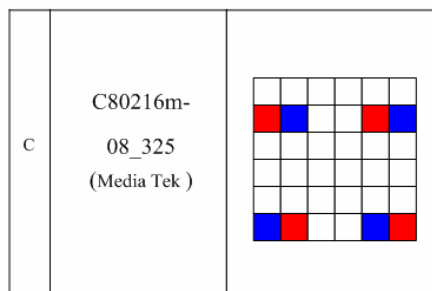

Fig. 9 Type C RB

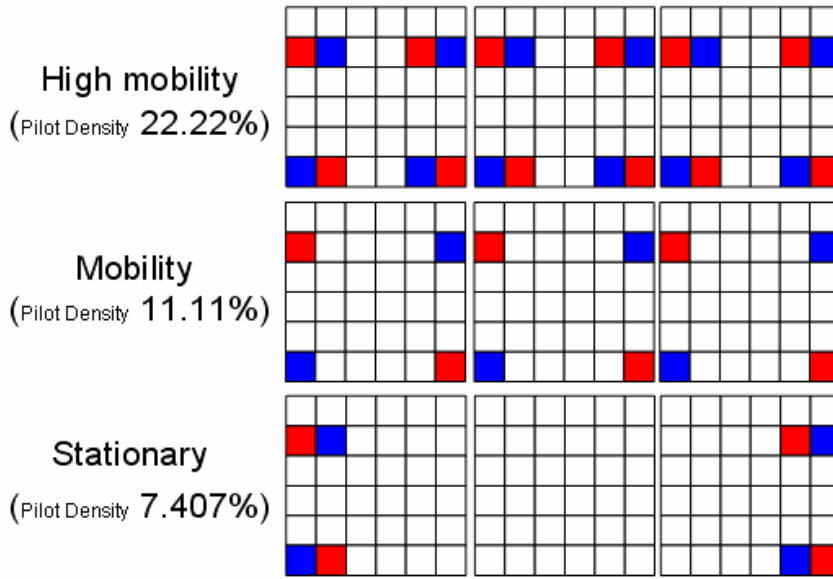

Fig. 10 Type C Different Speed Zones

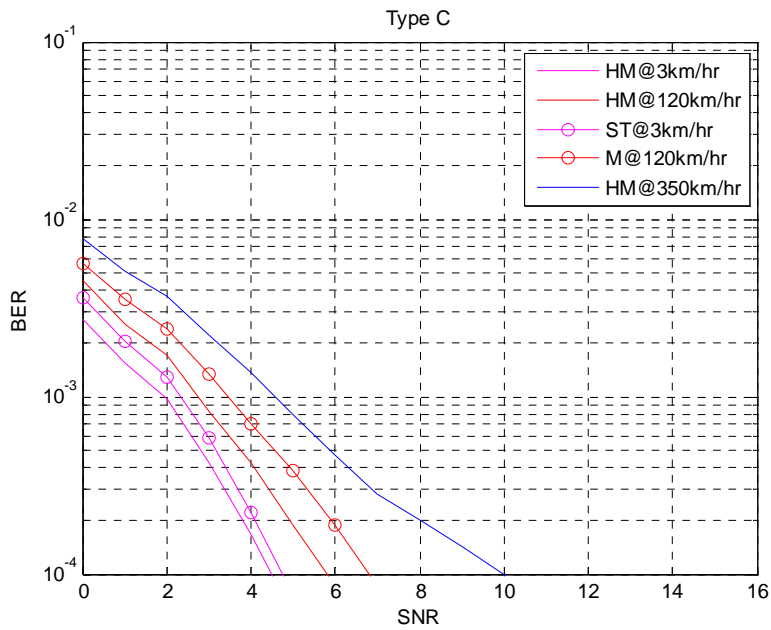

Fig. 11 Simulation Result for Type C Uplink Pilot Format

2.4 Type D RB

As shown in Fig. 12 is a Type D Resource Block, its Different Speed Zones has the structure as shown in Fig. 13. The simulation results at mobile speeds of 3 km/hr, 120 km/hr and 350 km/hr are shown in Fig. 14. In the simulation we also include the results when the pilot patterns implemented for 3 km/hr and 120 km/hr are based on the pilot structure for high mobility situation, their results are identified by prefixing with HM, e.g.

HM@3km/hr for MS with 3 km/hr MS. As shown in the simulation results it still can get the same system performance by using few pilots when the mobile speed is low.

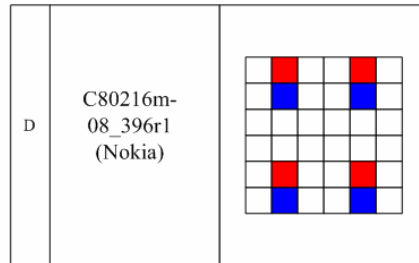

Fig. 12 Type D RB

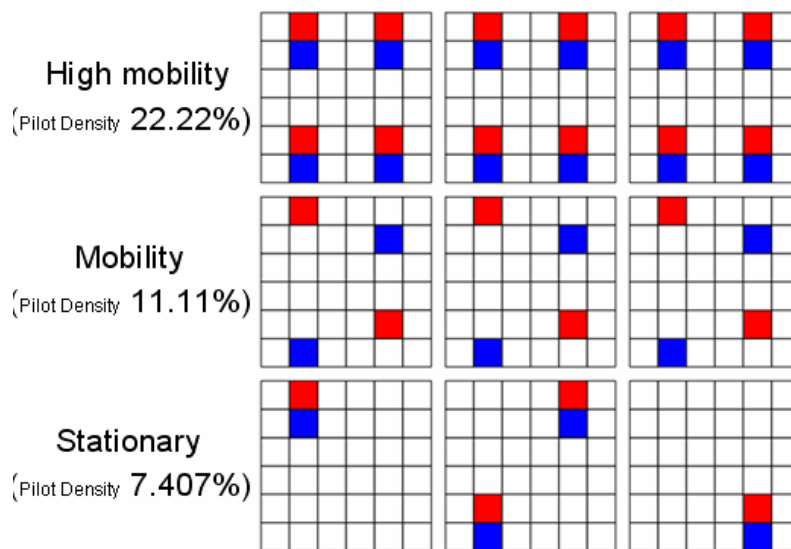

Fig. 13 Type D Different Speed Zones

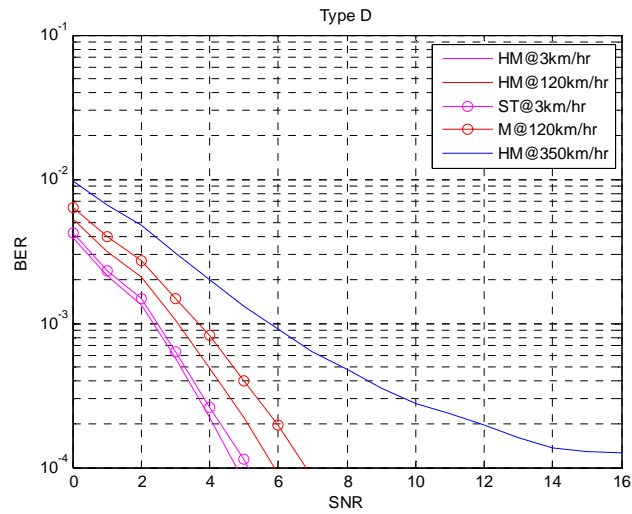

Fig. 14 Simulation Result for Type D Uplink Pilot Format

2.5 Type E RB

As shown in Fig.15 is a Type E Resource Block, its Different Speed Zones has the structure as shown in Fig. 16. The simulation results at mobile speeds of 3 km/hr, 120 km/hr and 350 km/hr are shown in Fig. 17. In the simulation we also include the results when the pilot patterns implemented for 3 km/hr and 120 km/hr are based on the pilot structure for high mobility situation, their results are identified by prefixing with HM, e.g. HM@3km/hr for MS with 3 km/hr MS. As shown in the simulation results it still can get the same system performance by using few pilots when the mobile speed is low.

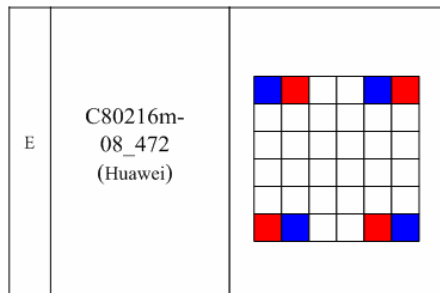

Fig. 15 Type E RB

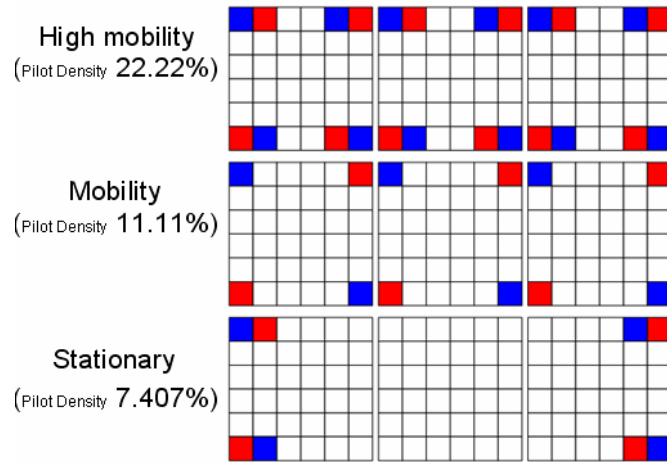

Fig. 16 Type E Different Speed Zones

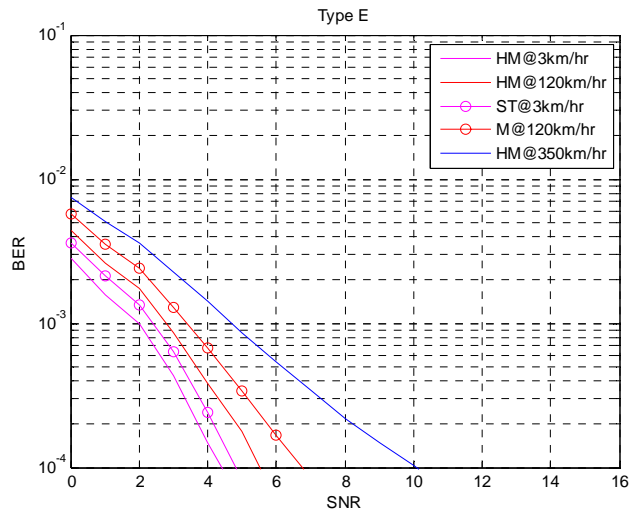

Fig. 17 Simulation Result for Type E Uplink Pilot Format

2.6 Type F RB

As shown in Fig. 18 is a Type F Resource Block, its Different Speed Zones has the structure as shown in Fig. 19. The simulation results at mobile speeds of 3 km/hr, 120 km/hr and 350 km/hr are shown in Fig. 20. In the simulation we also include the results when the pilot patterns implemented for 3 km/hr and 120 km/hr are based on the pilot structure for high mobility situation, their results are identified by prefixing with HM, e.g. HM@3km/hr for MS with 3 km/hr MS. As shown in the simulation results it still can get the same system performance by using few pilots when the mobile speed is low.

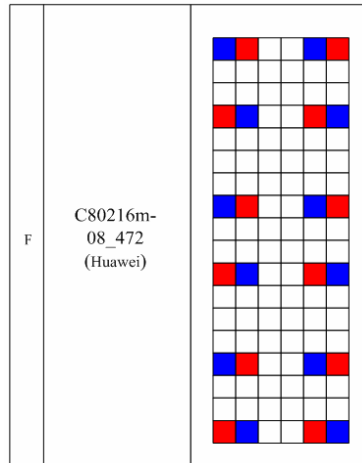

Fig. 18 Type F RB

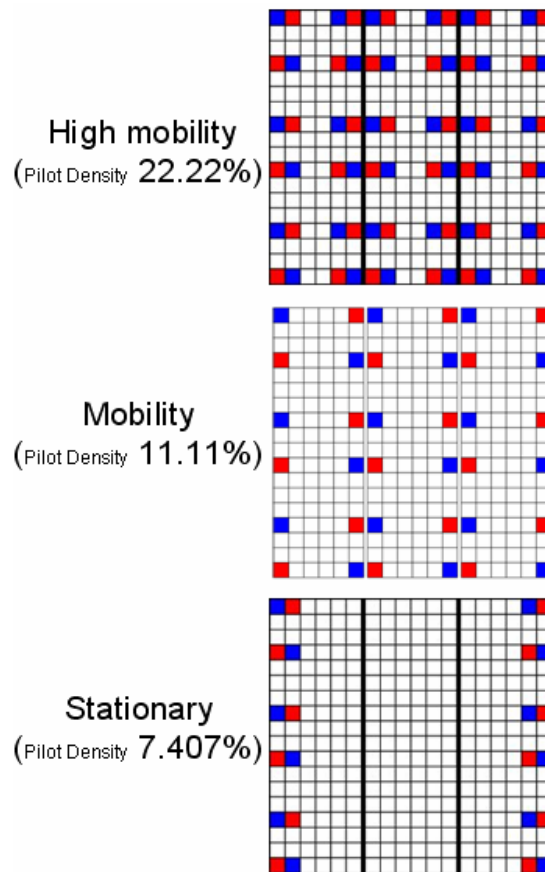

Fig. 19 Type F Different Speed Zones

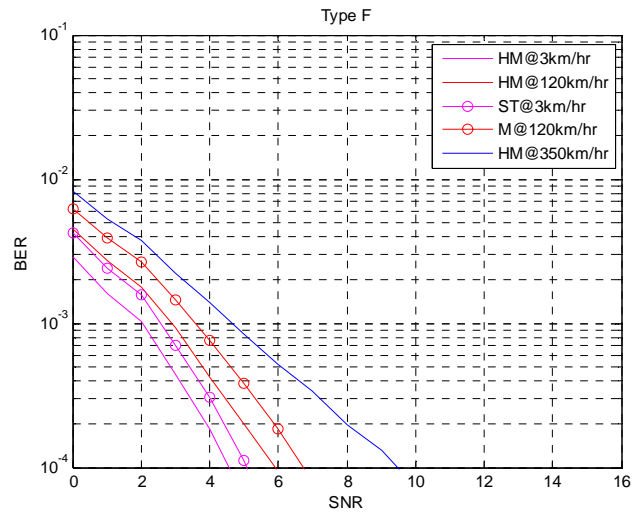

Fig. 20 Simulation Result for Type F Uplink Pilot Format

2.7 Type G RB

As shown in Fig. 21 is a Type G Resource Block, its Different Speed Zones has the structure as shown in Fig. 22. The simulation results at mobile speeds of 3 km/hr, 120 km/hr and 350 km/hr are shown in Fig. 23. In the simulation we also include the results when the pilot patterns implemented for 3 km/hr and 120 km/hr are based on the pilot structure for high mobility situation, their results are identified by prefixing with HM, e.g. HM@3km/hr for MS with 3 km/hr MS. As shown in the simulation results it still can get the same system performance by using few pilots when the mobile speed is low.

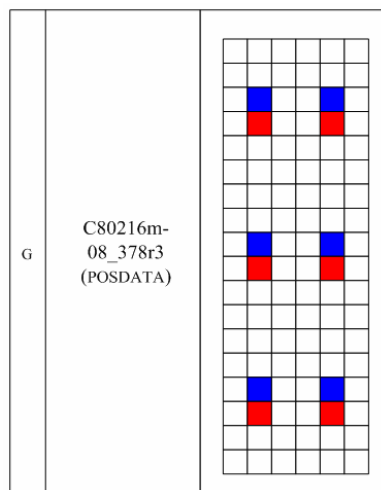

Fig. 21 Type G RB

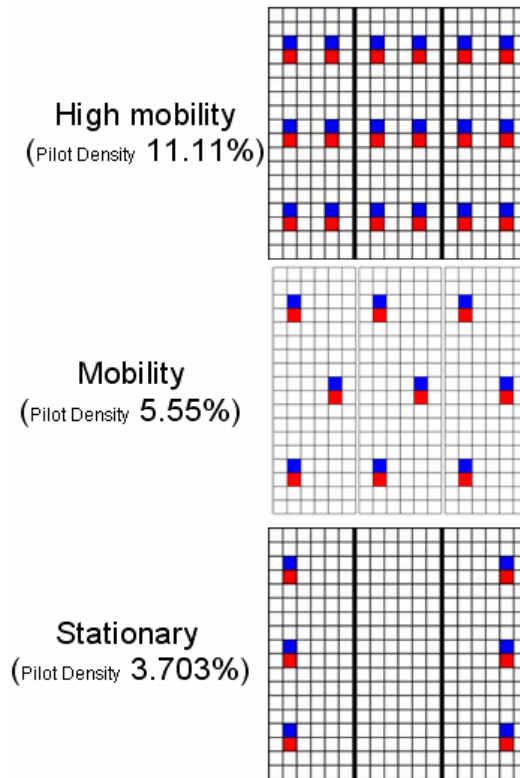

Fig. 22 Type G Different Speed Zones

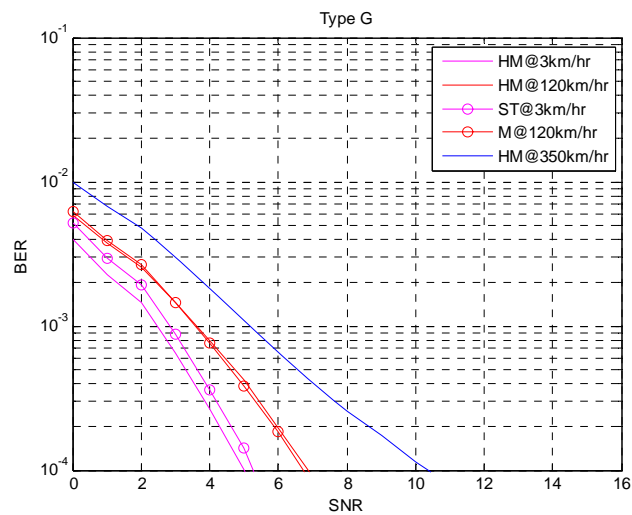

Fig. 23 Simulation Result for Type G Uplink Pilot Format

2.8 Type H RB

As shown in Fig. 24 is a Type H Resource Block, its Different Speed Zones has the structure as shown in Fig. 25. The simulation results at mobile speeds of 3 km/hr, 120 km/hr and 350 km/hr are shown in Fig. 26. In the simulation we also include the results when the pilot patterns implemented for 3 km/hr and 120 km/hr are

based on the pilot structure for high mobility situation, their results are identified by prefixing with HM, e.g. HM@3km/hr for MS with 3 km/hr MS. As shown in the simulation results it still can get the same system performance by using few pilots when the mobile speed is low.

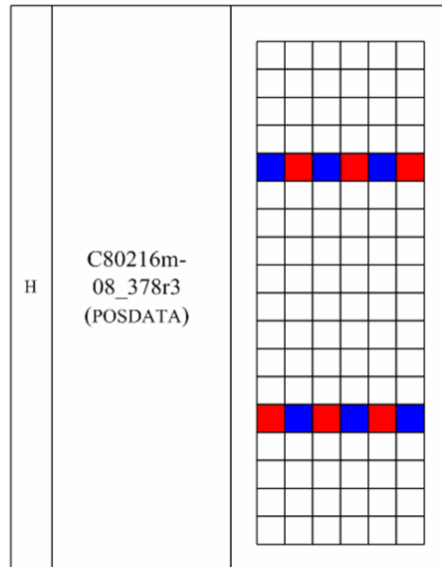

Fig. 24 Type H RB

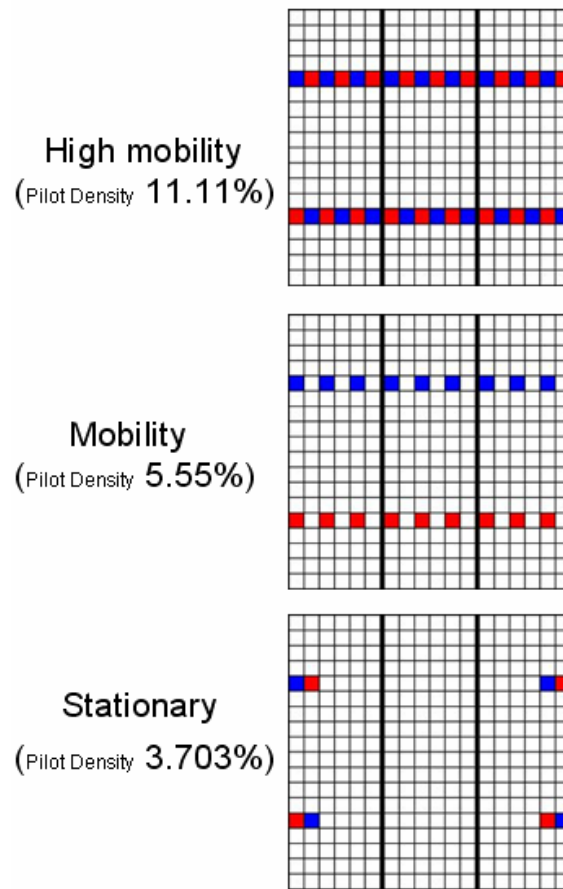

Fig. 25 Type H Different Speed Zones

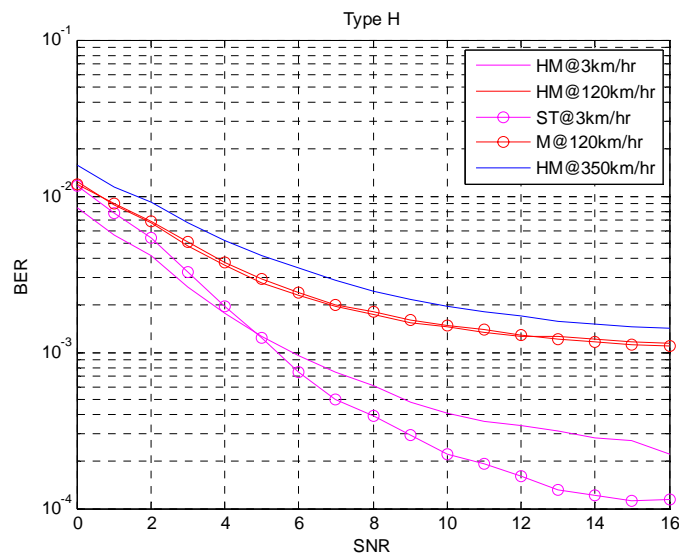

Fig. 26 Simulation Result for Type H Uplink Pilot Format

2.9 Type I RB

As shown in Fig. 27 is a Type I Resource Block, its Different Speed Zones has the structure as shown in Fig. 28. It is for 2 antennas situation. The simulation results at mobile speeds of 3 km/hr, 120 km/hr and 350 km/hr are shown in Fig. 29. In the simulation we also include the results when the pilot patterns implemented for 3 km/hr and 120 km/hr are based on the pilot structure for high mobility situation, their results are identified by prefixing with HM, e.g. HM@3km/hr for MS with 3 km/hr MS. As shown in the simulation results it still can get the same system performance by using few pilots when the mobile speed is low.

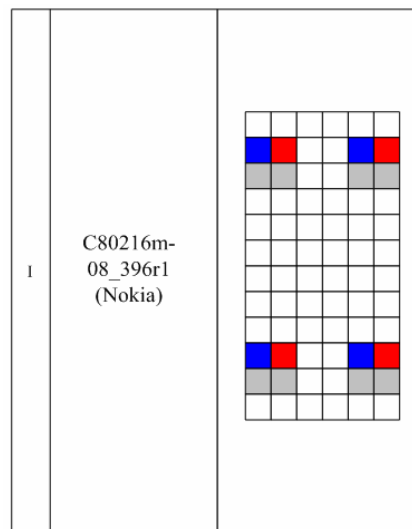

Fig. 28 Type I RB

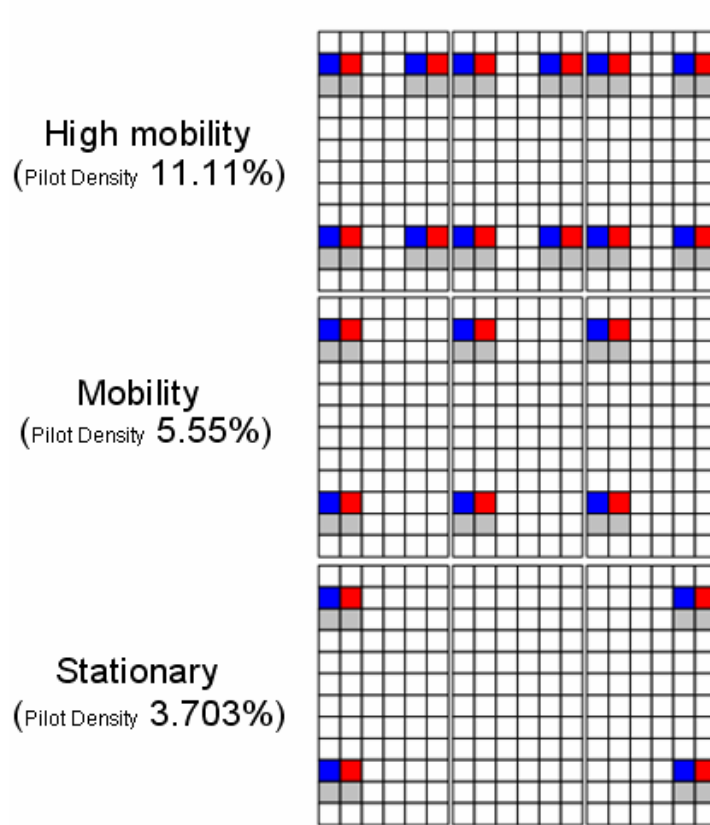

Fig. 28 Type I Different Speed Zones

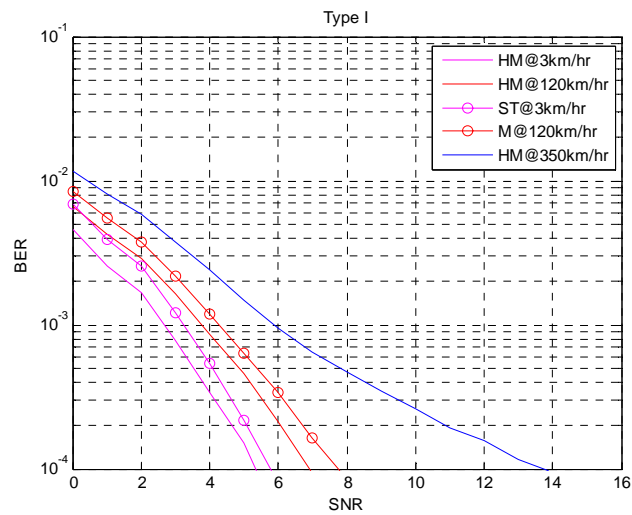

Fig. 29 Simulation Result for Type I Uplink Pilot Format

2.10 Type J RB

As shown in Fig. 30 is a Type J Resource Block, its Different Speed Zones has the structure as shown in Fig. 31. It is for 2 antenna situation. The simulation results at mobile speeds of 3 km/hr, 120 km/hr and 350 km/hr are shown in Fig. 32. In the simulation we also include the results when the pilot patterns implemented for 3 km/hr and 120 km/hr are based on the pilot structure for high mobility situation, their results are identified by prefixing with HM, e.g. HM@3km/hr for MS with 3 km/hr MS. As shown in the simulation results it still can get the same system performance by using few pilots when the mobile speed is low.

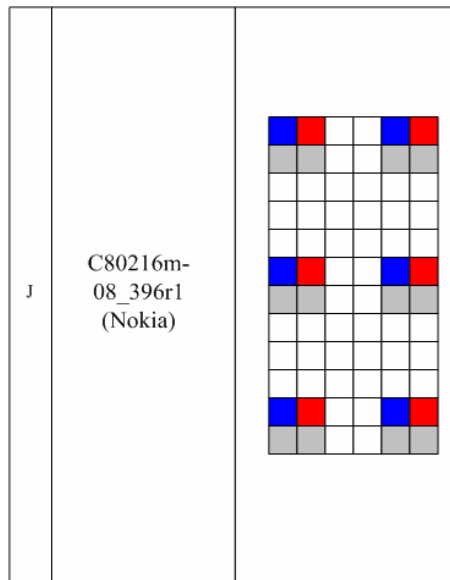

Fig. 30 Type J RB

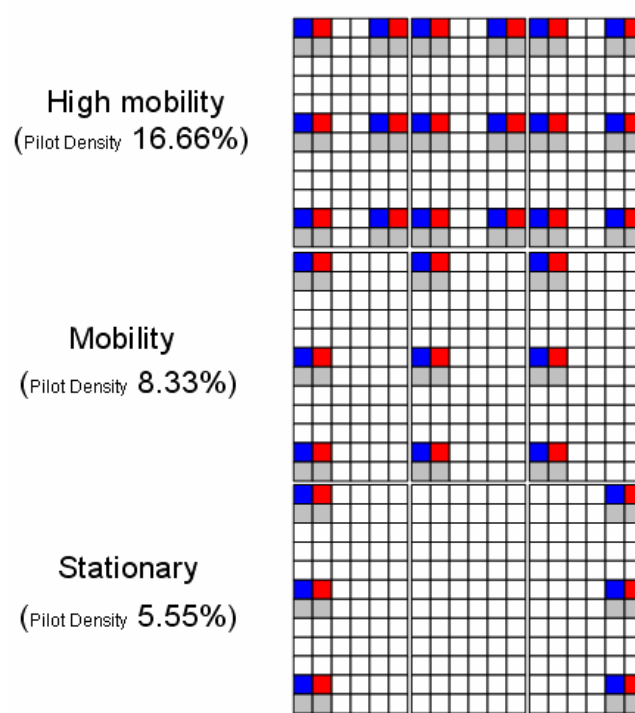

Fig. 31 Type J Different Speed Zones

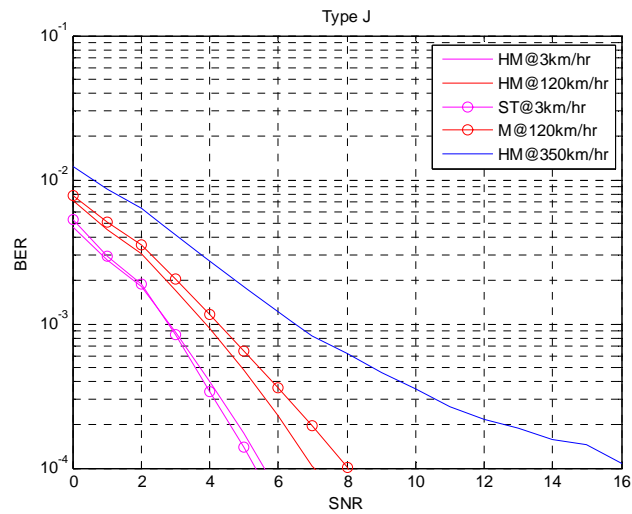

Fig. 32 Simulation Result for Type J Uplink Pilot Format

REFERENCES

- [1] *IEEE C802.16m-08/444r2, Yih-Guang Jan, Yang-Han Lee, Ming-Hsueh Chuang, Hsien-Wei Tseng, Jheng-Yao Lin, Hsi-Chun Tseng, Po-Jung Lin, Ting-Chien Wang, "Propose for Uplink Pilot Design in IEEE 802.16m"*
- [2] *IEEE C80216m-08_266r1, Yuval Lomnitz , Huaning Niu, Jong-kae (JK) Fwu, Sassan Ahmadi , Hujun Yin , Intel Corp., "UL symbol structure design for 802.16m -- symbol structure and pilot design "*
- [3] *IEEE C80216m-08_325, Chih-Yuan Lin, Pei-Kai Liao, Ciou-Ping Wu, and Paul Cheng, "Design Considerations of Pilot Structures for Uplink MIMO Transmission"*
- [4] *IEEE C80216m-08_396r1, Jianfeng Kang, Chao Wei, Xin Qi et. al., NSN & Nokia, "Uplink Physical Resource Allocation Unit (Resource blocks and Symbol Structures)"*
- [5] *IEEE C80216m-08_472, Hongjie Si, Xin Chang, Qi Li, Zhigang Rong, Jianmin Lu, "Uplink Pilot Structures"*
- [6] *IEEE C80216m-08_378r3, Dongjun Lee, Zhengzi Li, Jungnam Yun, Jaehyeong Kim, "Pilot Structures as relevant to Uplink MIMO"*
- [7] *IEEE C80216m-08_396r1, Jianfeng Kang, Chao Wei, Xin Qi et. al., NSN & Nokia, "Uplink Physical Resource Allocation Unit (Resource blocks and Symbol Structures)"*

Text Proposal for the 'Uplink MIMO Schemes'

=====Start of Proposed Text=====

XX.X Uplink MIMO Schemes

Different densities of pilot patterns can be exploited to estimate the channel impulse response to the same extent of accuracy when mobile speed varies. In Fig.X.1, it shows an example of pilot structures when the SS is moving in different speed zones.

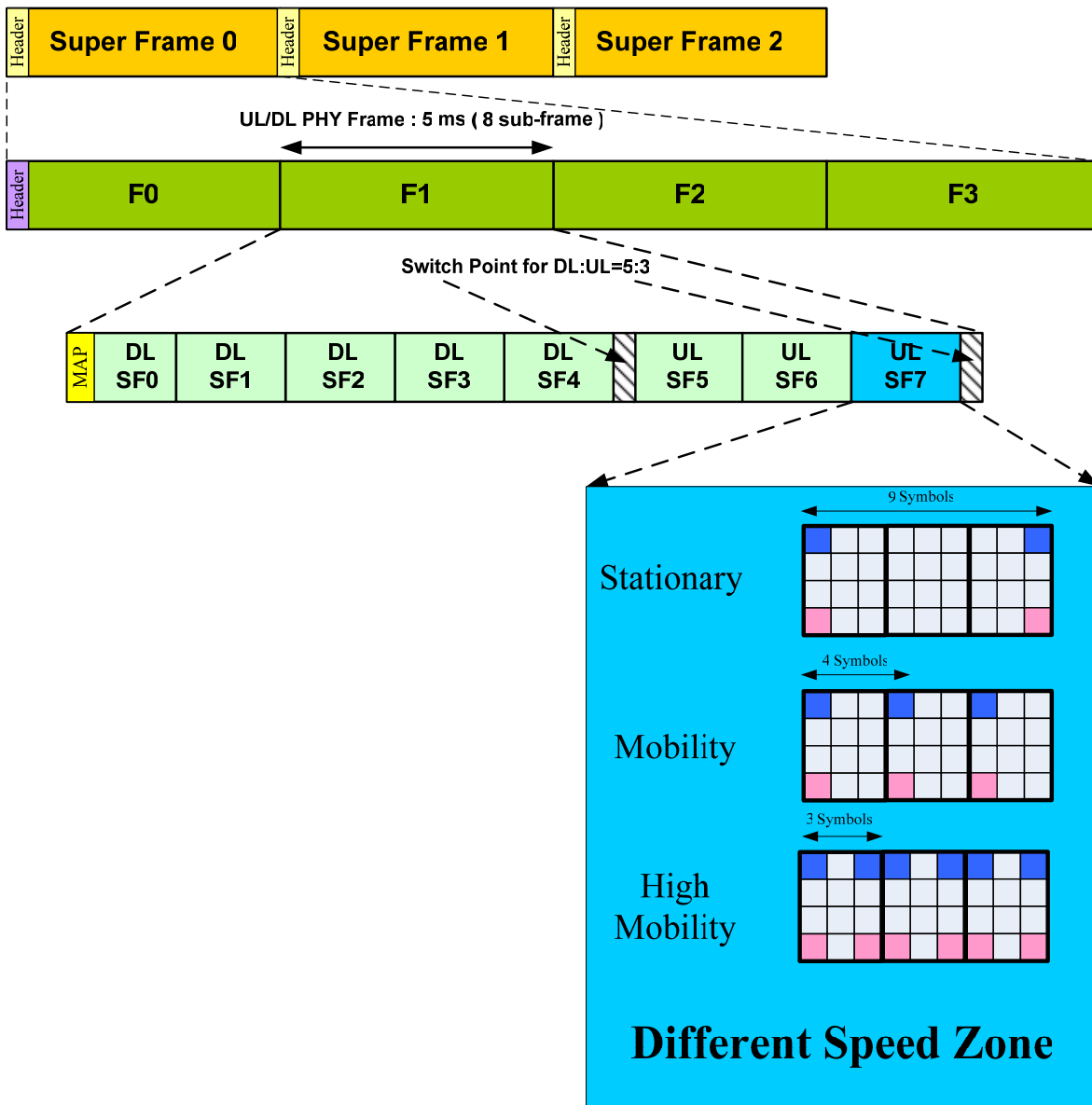

Fig.X.1. Pilot structures in different speed zones

=====*End of Proposed Text*=====