

Proposed A-MAP Relevance and HARQ Timing for the IEEE 802.16m (Design Principles and Key Features)

IEEE 802.16 Presentation Submission Template (Rev. 9)

Document Number:

IEEE C802.16m-09/0538r1

Date Submitted:

2009-03-11

Source:

Jaeweon Cho, Mihyun Lee, Hokyu Choi, Heewon Kang
Samsung Electronics Co., Ltd.

+82-31-279-5796

jaeweon.cho@samsung.com

Venue:

“802.16m AWD”

IEEE 802.16m-09/0012, “Call for Contributions on Project 802.16m Amendment Working Document (AWD) Content”.

- Call for Contributions for P802.16m AWD Proposals: Target topic – HARQ timing.

Base Contribution:

None

Purpose:

To be discussed and adopted by TGm for the 802.16m Amendment Working Document

Notice:

This document does not represent the agreed views of the IEEE 802.16 Working Group or any of its subgroups. It represents only the views of the participants listed in the “Source(s)” field above. It is offered as a basis for discussion. It is not binding on the contributor(s), who reserve(s) the right to add, amend or withdraw material contained herein.

Release:

The contributor grants a free, irrevocable license to the IEEE to incorporate material contained in this contribution, and any modifications thereof, in the creation of an IEEE Standards publication; to copyright in the IEEE’s name any IEEE Standards publication even though it may include portions of this contribution; and at the IEEE’s sole discretion to permit others to reproduce in whole or in part the resulting IEEE Standards publication. The contributor also acknowledges and accepts that this contribution may be made public by IEEE 802.16.

Patent Policy:

The contributor is familiar with the IEEE-SA Patent Policy and Procedures:

<<http://standards.ieee.org/guides/bylaws/sect6-7.html#6>> and <<http://standards.ieee.org/guides/opman/sect6.html#6.3>>.

Further information is located at <<http://standards.ieee.org/board/pat/pat-material.html>> and <<http://standards.ieee.org/board/pat>>.

Proposed A-MAP Relevance and HARQ Timing for the IEEE 802.16m (Design Principles and Key Features)

Jaeweon Cho, Mihyun Lee, Hokyung Choi, Heewon Kang

Samsung Electronics Co., Ltd.

March 2009

About this Contribution

- Goal and scope of this contribution
 - Introduce Design requirements for HARQ timing
 - Propose HARQ timing structure (in mathematical formula)
 - Show Benefits of the proposed HARQ timing
 - Present HARQ timings for various configurations in Appendix
- The proposed text for inclusion into the IEEE 802.16m AWD is shown in another contribution [IEEE C802.16m-09/0539](#)

HARQ Timings

- HARQ protocols specified in the 16m SDD
 - Asynchronous HARQ for DL
 - Synchronous HARQ for UL
- Open issue: the detailed timing of HARQ operation
 - HARQ Feedback Delay
 - Both synchronous and asynchronous HARQ benefit from a predefined HARQ feedback delay
 - HARQ Retransmission Time
 - Synchronous HARQ in UL requires a predefined HARQ ReTx interval
 - The predefined HARQ ReTx interval is of benefit to power saving even in DL with asynchronous HARQ

A-MAP Relevance

- DL A-MAP Relevance

- A-MAP Tx period = 1

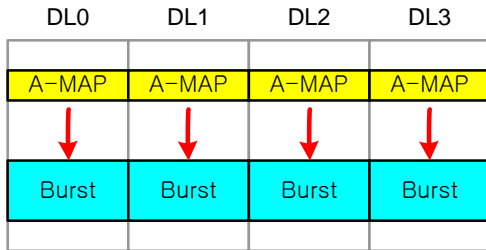

- A-MAP Tx period = 2

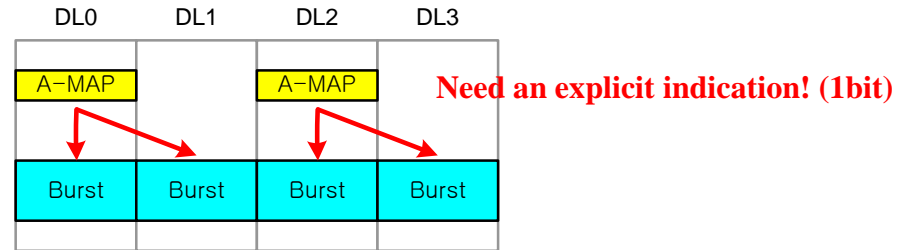

- UL A-MAP Relevance

- A-MAP Tx period = 1

No need of an explicit indication.
Just need a mapping rule.

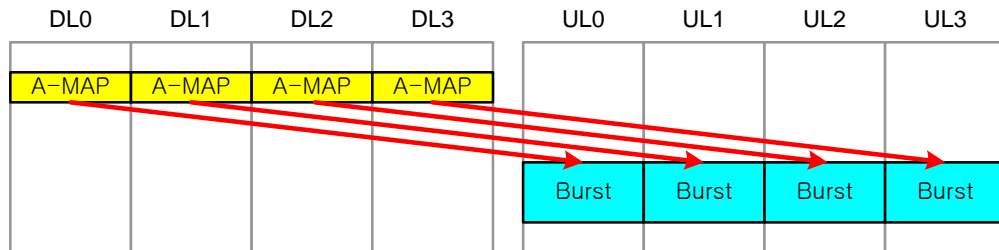

- A-MAP Tx period = 2

Need both an explicit indication
(1bit) and a mapping rule.

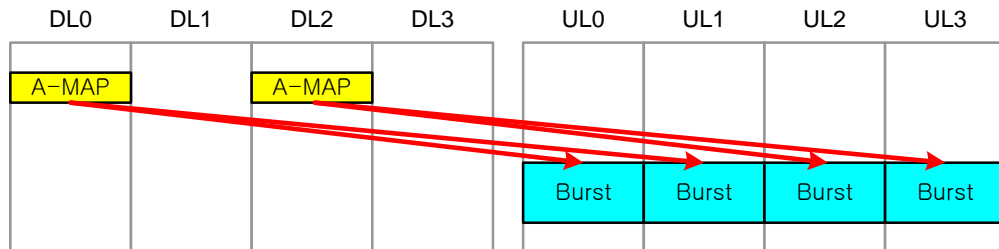

- In design of HARQ timing, A-MAP relevance shall be also considered.

Design Requirements

HARQ timing should ...

- ① Represented by Mathematical formula for various configurations
 - FDD and TDD (3:5, 4:4, 5:3, 6:2)
 - 5/10/20MHz, 8.75MHz, 7MHz BWs (8, 7, 6 subframes per frame)
 - Legacy support
 - A-MAP Tx period = 1 or 2
 - Long TTI transmission
- ② Maximize MS power saving and Efficiently support CLC (Co-Located coexistence)
 - Provide a periodic HARQ timing for both feedback and Re-Tx
 - Provide the synchronized DL and UL HARQ operations
- ③ Provide uniformly-distributed HARQ feedback timings
- ④ Support BS/MS with various capabilities in an efficient way
 - Tx/Rx processing times of 2 subframes and 3 subframes
- ⑤ Be aligned with A-MAP relevance (particularly, in UL)

Tx/Rx Processing Time

- One of key considerations in design of MAP relevance and HARQ timing
 - ① Rx processing time at MS includes ...
 - DL A-MAP decoding, Data burst decoding, ACK/NACK encoding
 - ② Tx processing time at MS includes ...
 - UL A-MAP or ACK/NACK decoding, Data burst encoding
 - ③ Rx processing time at BS includes ...
 - Data burst decoding, Scheduling, ACK/NACK or UL A-MAP encoding
 - ④ Tx processing time at BS includes ...
 - ACK/NCACK decoding, Scheduling, DL A-MAP encoding, Data burst encoding
- The processing time in 16m: *2 subframes, 3 subframes*
 - Reasonable assumption, considering the implementation in near future and competitiveness with other standards
 - Note: 3 subframes in LTE, 2 subframes and 3 subframes in UMB

HARQ Timing in FDD DL

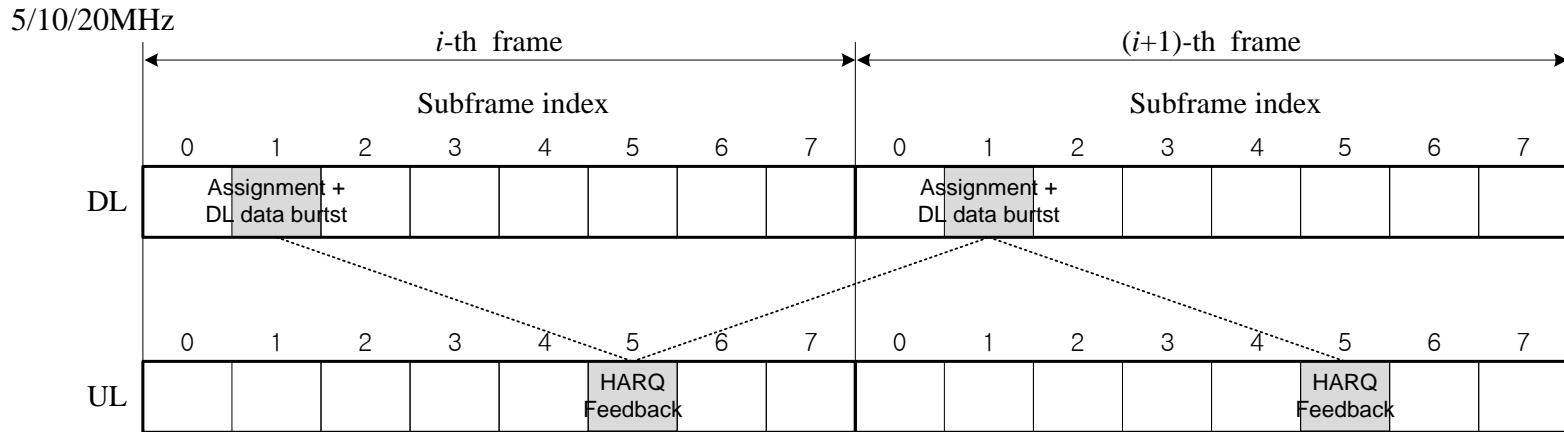

Content	Subframe index	Frame index
Tx of Assignment IE in DL	l	i
Data burst Tx in DL	$m = \begin{cases} l, & \text{for } N_{A-MAP} = 1 \\ l \text{ or } l + 1, & \text{for } N_{A-MAP} = 2 \end{cases}$	i
HARQ feedback in UL	$n = \text{ceil}(m+F/2) \bmod F$	$j = (i + \text{floor}(\text{ceil}(m+F/2)/F) + z) \bmod 4$

- N_{A-MAP} : A-MAP transmission period
- F : num of subframe / frame (8 for 5/10/20MHz, 7 for 8.75MHz, 6 for 7MHz)
- z : DL HARQ feedback offset - 0 for fast feedback timing, 1 for slow feedback timing (see the slide 12)

HARQ Timing in FDD UL

5/10/20MHz

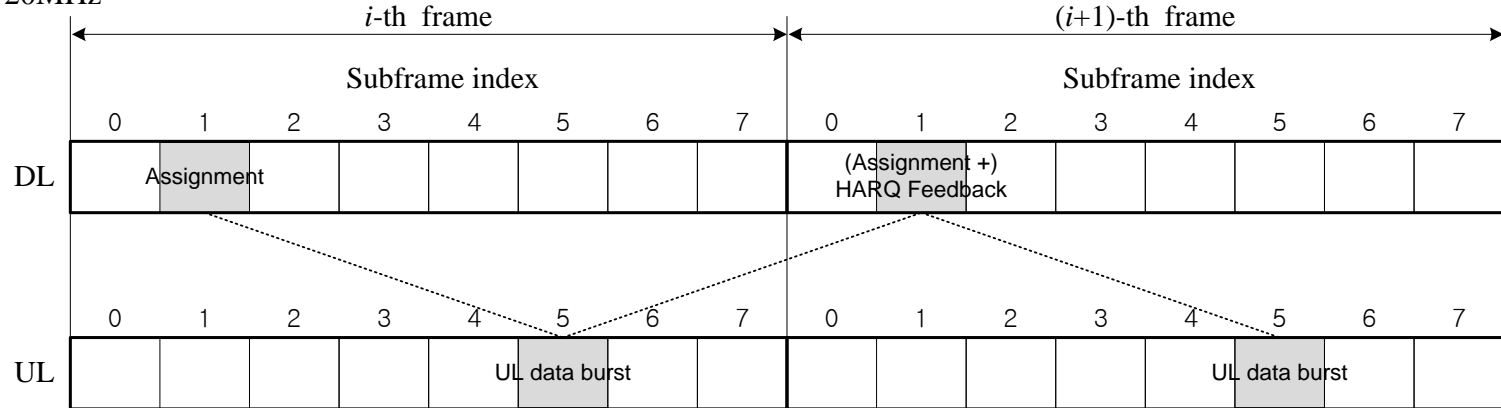

Content	Subframe index	Frame index
Tx of Assignment IE in DL	l	i
Data burst Tx in UL	$m = \begin{cases} n, & \text{for } N_{A-MAP} = 1 \\ n \text{ or } n + 1, & \text{for } N_{A-MAP} = 2 \end{cases}$ <p>where $n = \text{ceil}(l + F/2) \bmod F$</p>	$j = (i + \text{floor}(\text{ceil}(l + F/2)/F) + \nu) \bmod 4$
HARQ feedback in DL	l	$k = (j + \text{floor}((m + F/2)/F) + w) \bmod 4$
Data burst Tx in UL	m	$p = (k + \text{floor}(\text{ceil}(l + F/2)/F) + \nu) \bmod 4$

- N_{A-MAP} : A-MAP transmission period
- F : num of subframe / frame (8 for 5/10/20MHz, 7 for 8.75MHz, 6 for 7MHz)
- w : UL HARQ feedback offset - 0 for fast feedback timing, 1 for slow feedback timing (see the slide 13)
- ν : UL HARQ Tx offset - 0 for fast Tx timing, 1 for slow Tx timing (see the slide 13)

HARQ Timing in TDD DL

5/10/20MHz D:U=5:3

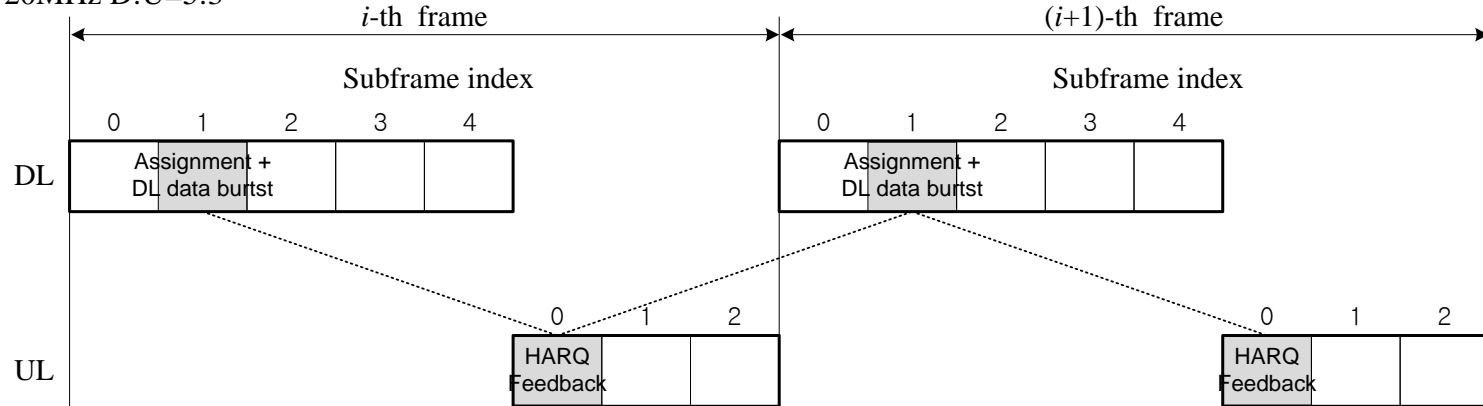

Content	Subframe index	Frame index
Tx of Assignment IE in DL	l	i
Data burst Tx in DL	$m = \begin{cases} l, & \text{for } N_{A-MAP} = 1 \\ l \text{ or } l + 1, & \text{for } N_{A-MAP} = 2 \end{cases}$	i
HARQ feedback in UL	For $D \geq U$, $n = \begin{cases} 0, & \text{for } 0 \leq m < K \\ m - K, & \text{for } K \leq m < U + K \\ U - 1, & \text{for } U + K \leq m < D \end{cases}$ For $D < U$, $n = m - K$	$j = (i+z) \bmod 4$

- N_{A-MAP} : A-MAP transmission period
- $K = \text{ceil}((D-U)/2)$ for $D \geq U$, and $K = -\text{ceil}((U-D)/2)$ for $D < U$.
- z : DL HARQ feedback offset - 0 for fast feedback timing, 1 for slow feedback timing (see the slide 12)

HARQ Timing in TDD UL (1/2)

Content	Subframe index	Frame index
Tx of Assignment IE in DL	l	i
Data burst Tx in UL	<p>For $\text{ceil}(D/N_{A-MAP}) \geq U$,</p> $m = \begin{cases} 0, & \text{for } 0 \leq l < K \\ l - K, & \text{for } K \leq l < U + K \\ U - 1, & \text{for } U + K \leq l < D \end{cases}$ <p>For $\text{ceil}(D/N_{A-MAP}) < U$,</p> <p>For $N_{A-MAP} = 1$,</p> $m = \begin{cases} 0 \text{ or } 1, & \text{for } l = 0 \\ l - K, & \text{for } 0 < l < D - 1 \\ U - 1, & \text{for } l = D - 1 \end{cases}$ <p>For $N_{A-MAP} = 2$,</p> $m = \begin{cases} 0 \text{ or } 1, & \text{for } l = 0 \\ l - K \text{ or } l - K + 1, & \text{for } 0 < l < D - 1 \\ U - 1, & \text{for } l = D - 1 \end{cases}$	$j = (i+v) \bmod 4$
HARQ feedback in DL	l	$k = (j+1+w) \bmod 4$
Data burst ReTx in UL	m	$p = (k+v) \bmod 4$

- N_{A-MAP} : A-MAP transmission period
- w : UL HARQ feedback offset - 0 for fast feedback timing, 1 for slow feedback timing (see the slide 13)
- v : UL HARQ Tx offset - 0 for fast Tx timing, 1 for slow Tx timing (see the slide 13)

HARQ Timing in TDD UL (2/2)

5/10/20MHz D:U=5:3

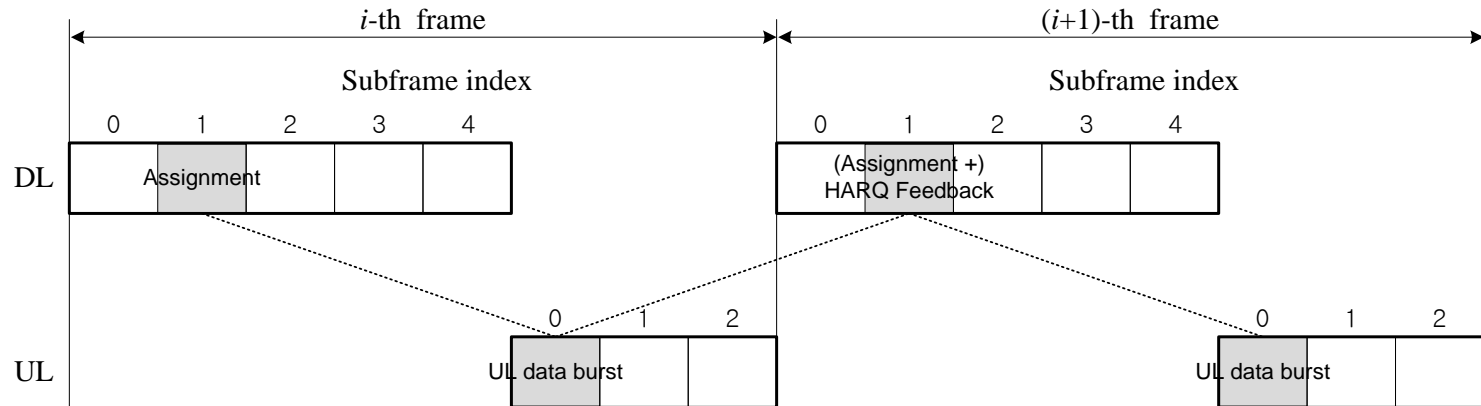

HARQ Timing Illustration – TDD 5:3

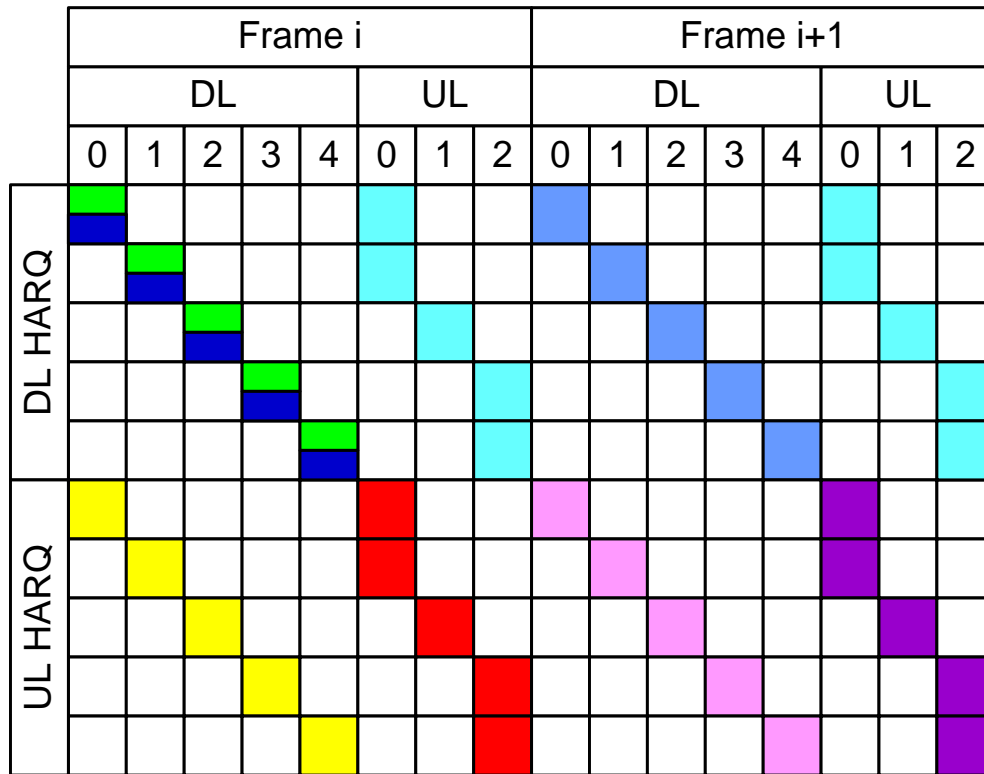

- The timing above provides a time gap of at least 2 subframes for Tx/Rx processing
- If a longer time gap (i.e. 3 subframes) should be secured,
 - DL: a slow interlace is applied to subframe DL4 (see the slide after next)
 - UL: Tx of UL A-MAP is limited to subframe DL1, DL2, and DL3.

HARQ Timing Illustration – TDD 3:5

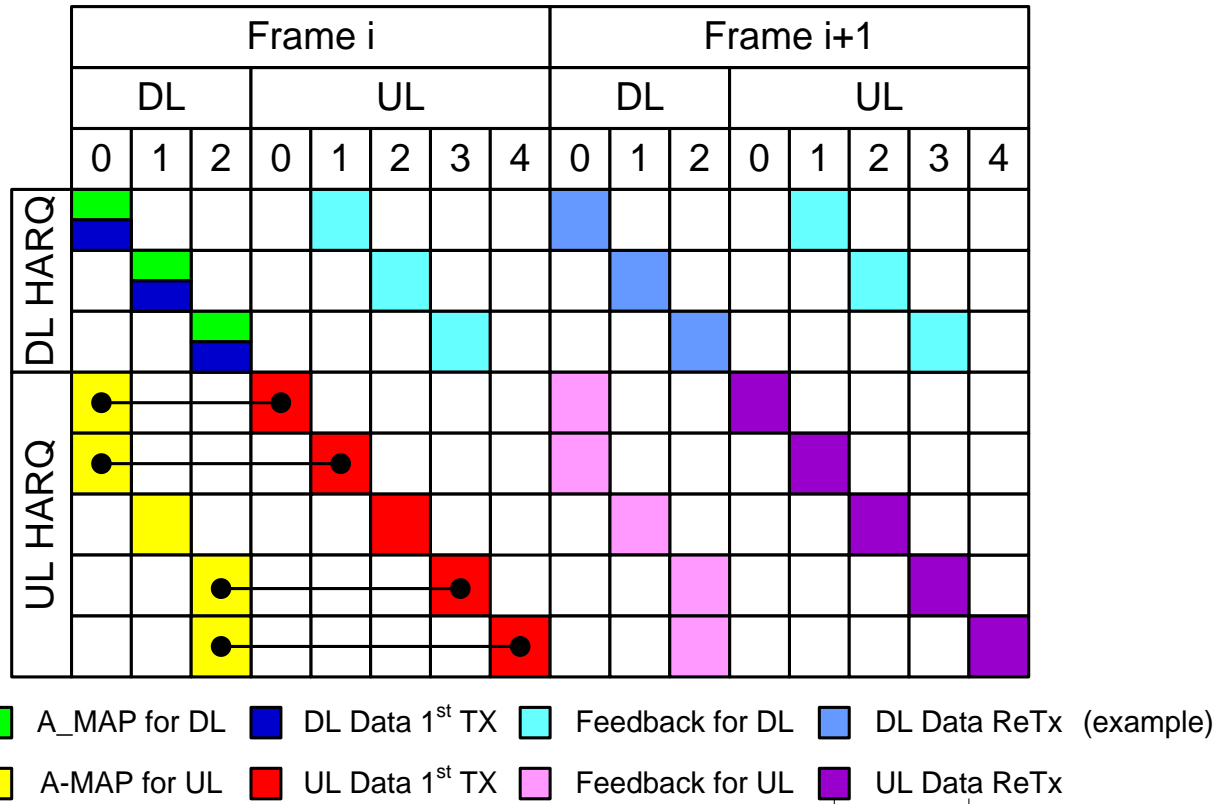

- Both A-MAPs for UL0 and UL1 are transmitted in the same DL subframe (DL0)
- So, UL A-MAP IE shall include an indication of the assigned UL subframe

Two HARQ Timing Options (DL)

- DL feedback timing
 - ① Fast feedback (in the same frame) : $z = 0$
 - ② Slow feedback (in the next frame) : $z = 1$
- Example – the last DL subframe in 5:3 TDD
 - If Rx processing time at MS = 2 subframe, the fast feedback ($z = 0$) is applied

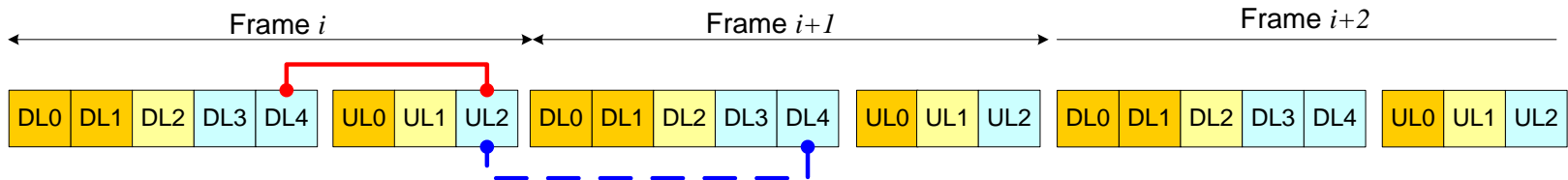

- Else (Rx processing time = 3 subframe), the slow feedback ($z = 1$) is applied

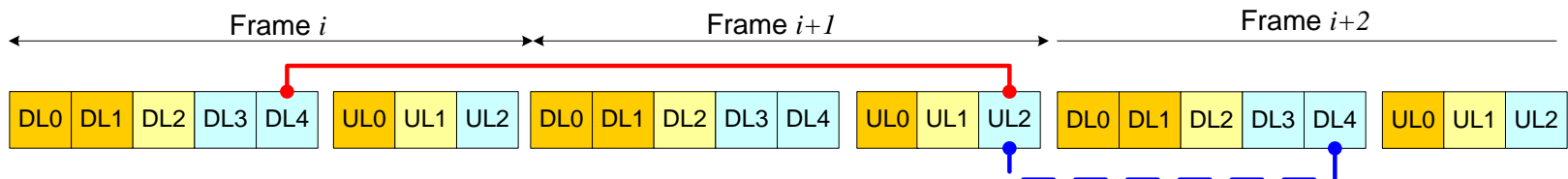

Two HARQ Timing Options (UL)

- UL data Tx timing (UL A-MAP relevance & ReTx timing)

- ① Fast transmission : $v = 0$,
- ② Slow transmission : $v = 1$

- Example – the first UL subframe in 3:5 TDD

- If Rx processing time at MS = 2 subframe, the fast transmission ($v = 0$) is applied

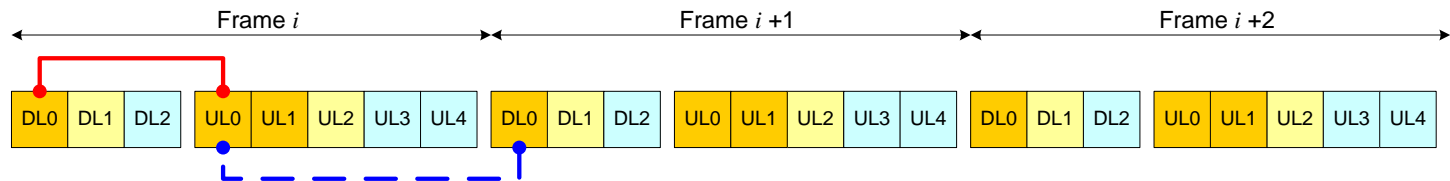

- Else (Rx processing time = 3 subframe), the slow transmission ($v = 1$) is applied

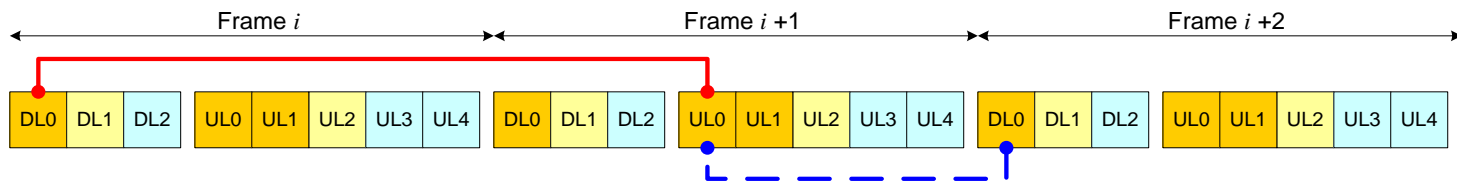

- UL feedback timing

- ① Fast feedback : $w = 0$,
- ② Slow feedback : $w = 1$

- Same as in downlink

Timings for Various D/U ratios

Tx/Rx processing = 2 subframes

D:U = 3:5	DL			UL				
	0	1	2	0	1	2	3	4
DL HARQ	F	F	F		F	F	F	
UL HARQ	F	F	F	F	F	F	F	F

Tx/Rx processing = 3 subframes

D:U = 3:5	DL			UL				
	0	1	2	0	1	2	3	4
DL HARQ	F	F	F		F	F	F	
UL HARQ	S/F	F	F/S	S	F	F	F	S

DL HARQ

F: fast feedback
(ACK in the same frame)
S: slow feedback
(ACK in the next frame)

D:U = 4:4	DL				UL			
	0	1	2	3	0	1	2	3
DL HARQ	F	F	F	F	F	F	F	F
UL HARQ	F	F	F	F	F	F	F	F

D:U = 4:4	DL				UL			
	0	1	2	3	0	1	2	3
DL HARQ	F	F	F	F	F	F	F	F
UL HARQ	F	F	F	F	F	F	F	F

UL HARQ

F: fast interlace
(5ms Re-Tx interal)
S: slow interlace
(10ms Re-Tx interal)

D:U = 5:3	DL					UL		
	0	1	2	3	4	0	1	2
DL HARQ	F	F	F	F	F	F	F	F
UL HARQ	F	F	F	F	F	F	F	F

D:U = 5:3	DL					UL		
	0	1	2	3	4	0	1	2
DL HARQ	F	F	F	F	S	F	F	F/S
UL HARQ		F	F	F		F	F	F

D:U = 6:2	DL						UL	
	0	1	2	3	4	5	0	1
DL HARQ	F	F	F	F	F	S	F	F/S
UL HARQ		F	F	F	F		F	F

D:U = 6:2	DL						UL	
	0	1	2	3	4	5	0	1
DL HARQ	F	F	F	F	S	S	F	F/S
UL HARQ			F	F			F	F

Features/Benefits of the Proposal

The proposed HARQ timing represented in the mathematical formula ...

- Can be applied to all needed scenarios in 802.16m:
 - FDD, TDD (3:5, 4:4, 5:3, 6:2)
 - 5/10/20MHz (8 subframes/frame), 8.75MHz (7 subframes/frame), 7MHz (6 subframes/frame)
 - Frame Structure of Legacy support
 - A-MAP Tx period = 1 or 2
 - Long TTI transmission
- Maximize the efficiency of MS power saving and CLC
 - Periodic HARQ timing for both feedback and re-transmission
 - Synchronize DL and UL active cycles
- Balance the load of UL control signaling among subframes
 - By providing Uniformly-distributed HARQ feedbacks
- Very flexible but efficient to support the Tx/Rx processing times of 2 subframes and 3 subframes
- Be aligned with A-MAP relevance in UL
 - The same interval for “from A-MAP to Data Tx” and “from Feedback to Data Re-Tx”

Periodic HARQ Timing

- A periodic Rx/Tx (duty cycle) is easily utilized for ...
 - **Power Saving and CLC support**

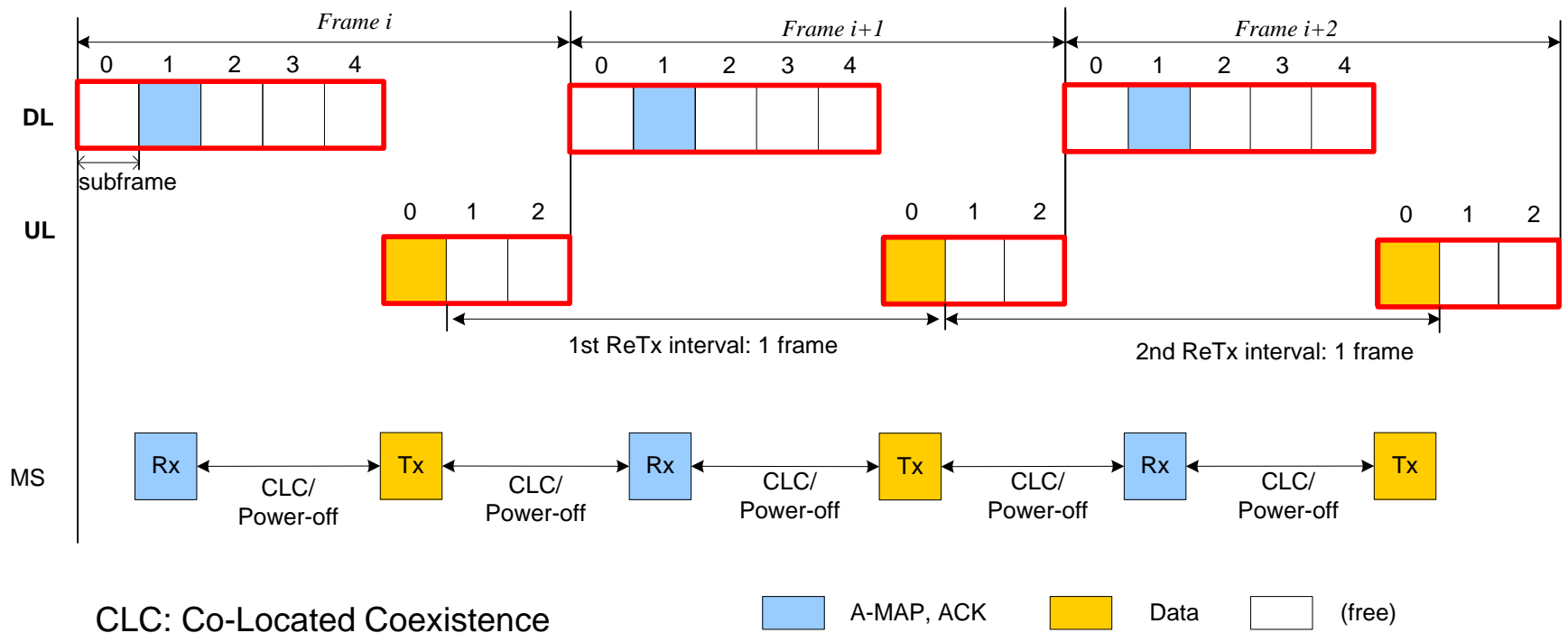

Synchronize DL and UL Active Cycles

- Maximize Power Saving at MS
 - Same association of subframe for DL and UL HARQ operations
 - ⇒ Synchronize DL and UL active cycles

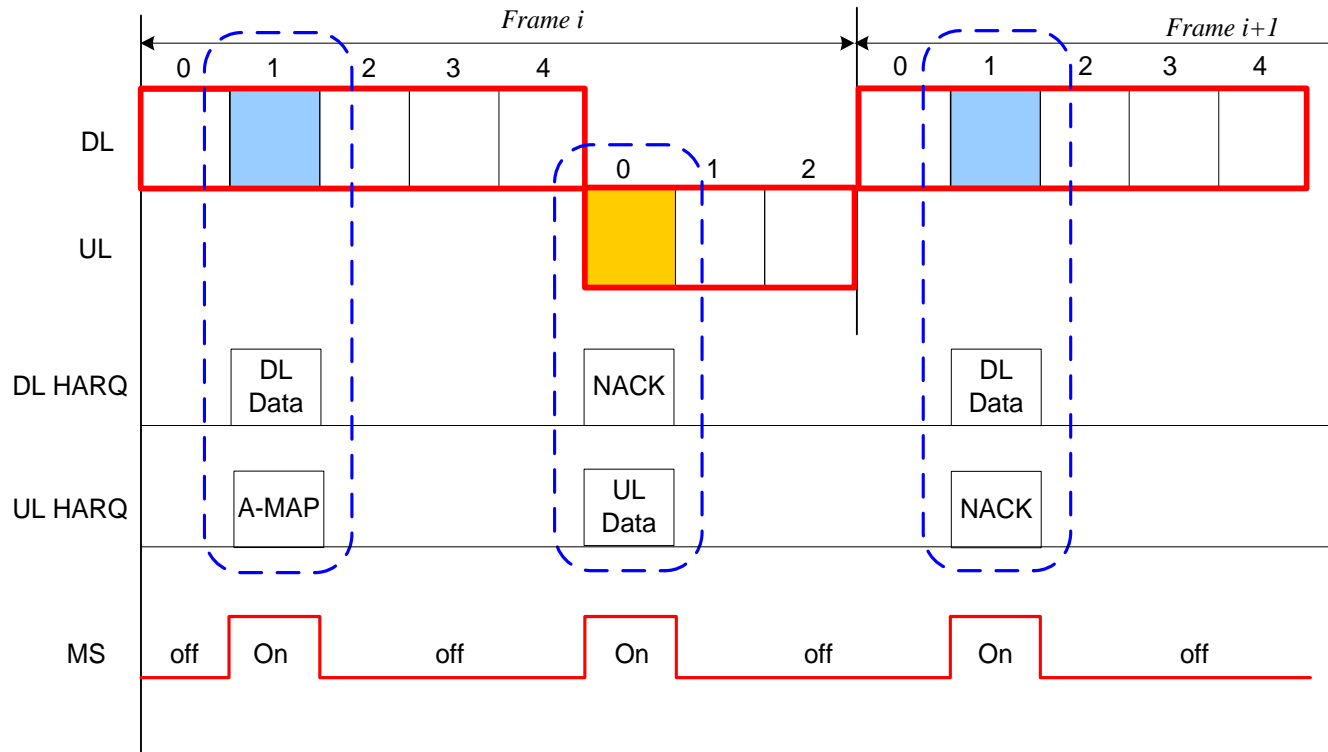

Note: MS is active only in DL subframe #1 and UL subframe #0; 1/4 activity

Uniformly-Distributed Feedbacks

- Each subframe has the same/similar number of associated subframes
 - Avoid the case when a number of HARQ feedbacks flow into a specific subframe

6 : 2 TDD

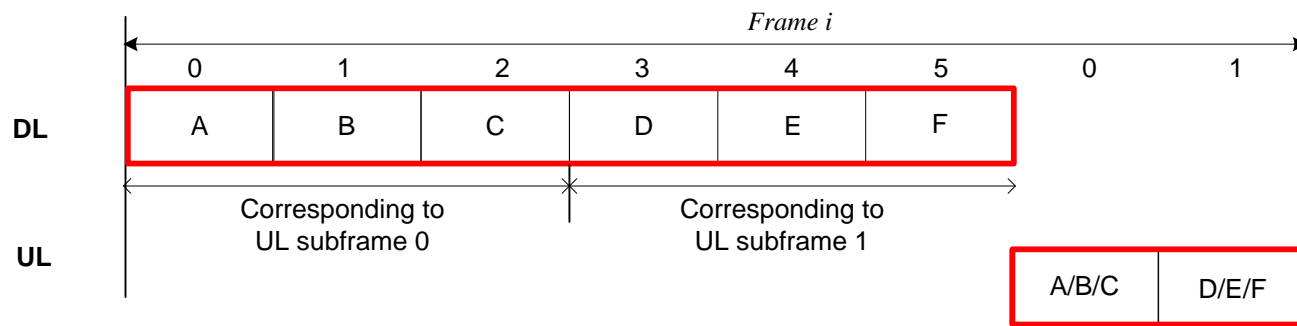

6 : 2 TDD, 2 subframe processing time

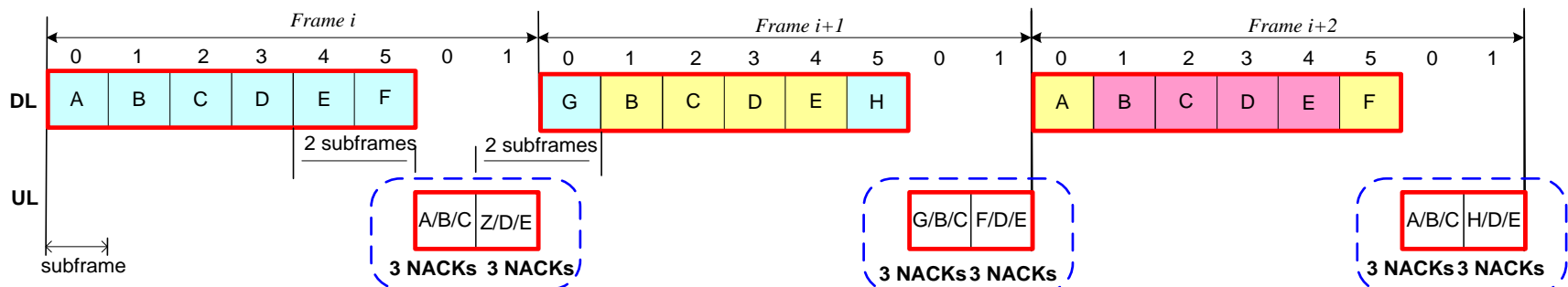

5ms RTT: B, C, D, E

10ms RTT: A, F, G, H

Initial Tx 1st Re-Tx 2nd Re-Tx

Appendix: HARQ timing illustration for ...

- 1) Legacy Support
- 2) 8.75MHz, 7MHz Frames
- 3) A-MAP Tx period = 2
- 4) Long TTI transmission

Legacy Support – TDD 5:3 (1/2)

- 16e:16m = 2:3 (UL FDM)

⇒ D:U = 3:3 at 16m (the same equation applied)

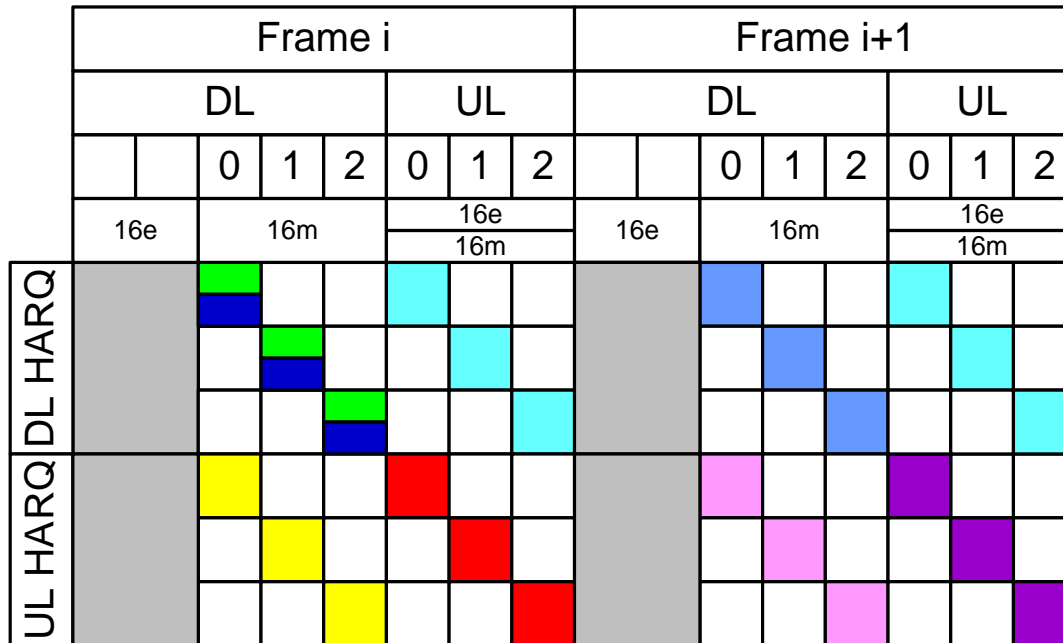

- A-MAP for DL
- DL Data 1st TX
- Feedback for DL
- DL Data ReTx (example)
- A-MAP for UL
- UL Data 1st TX
- Feedback for UL
- UL Data ReTx

Legacy Support – TDD 5:3 (2/2)

- 16e:16m = 3:2 (UL FDM)

⇒ D:U = 2:3 at 16m (the same equation applied)

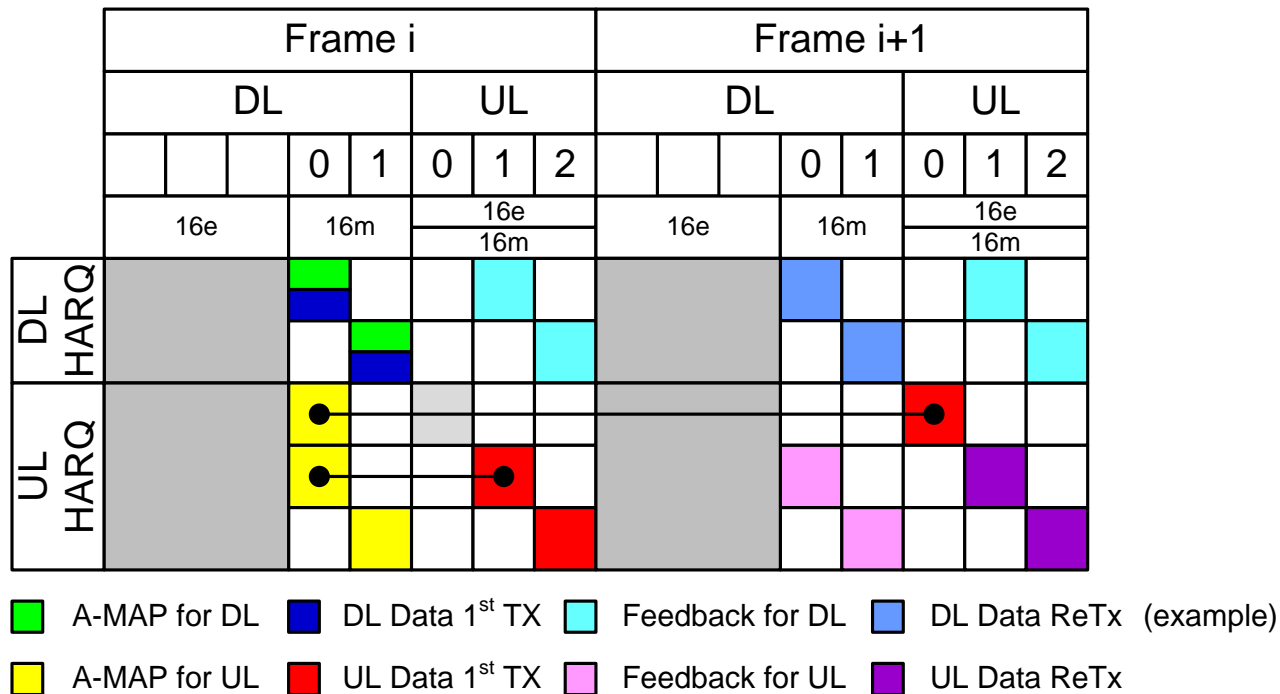

- Both A-MAPs for UL0 and UL1 are transmitted in the same DL subframe (DL0)
- So, UL A-MAP IE shall include an indication of the assigned UL subframe

8.75MHz Frame Structure (TDD 5:2)

- The same equation applied [For the details of 8.75MHz frame structure, see IEEE C802.16m-09/0275r1]

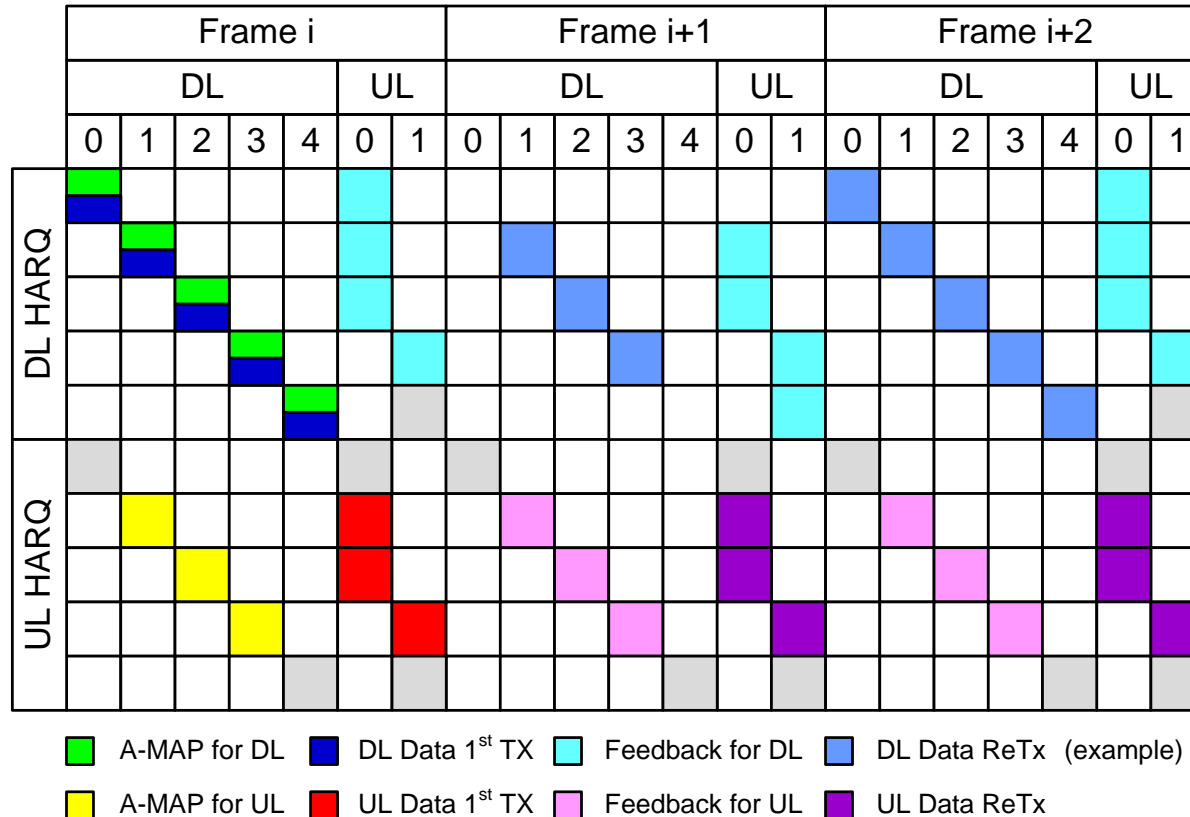

- The timing above provides a time gap of at least 2 subframes for Tx/Rx processing
- The gray-filled square indicates the expected timing but no transmission due to a too short Tx/Rx interval (1 subframe)
- If a longer time gap (3 subframes) should be secured, a slow interlace is applied

7MHz Frame Structure (TDD 4:2)

- The same equation applied [For the details of 7MHz frame structure, see IEEE C802.16m-09/0275r1]

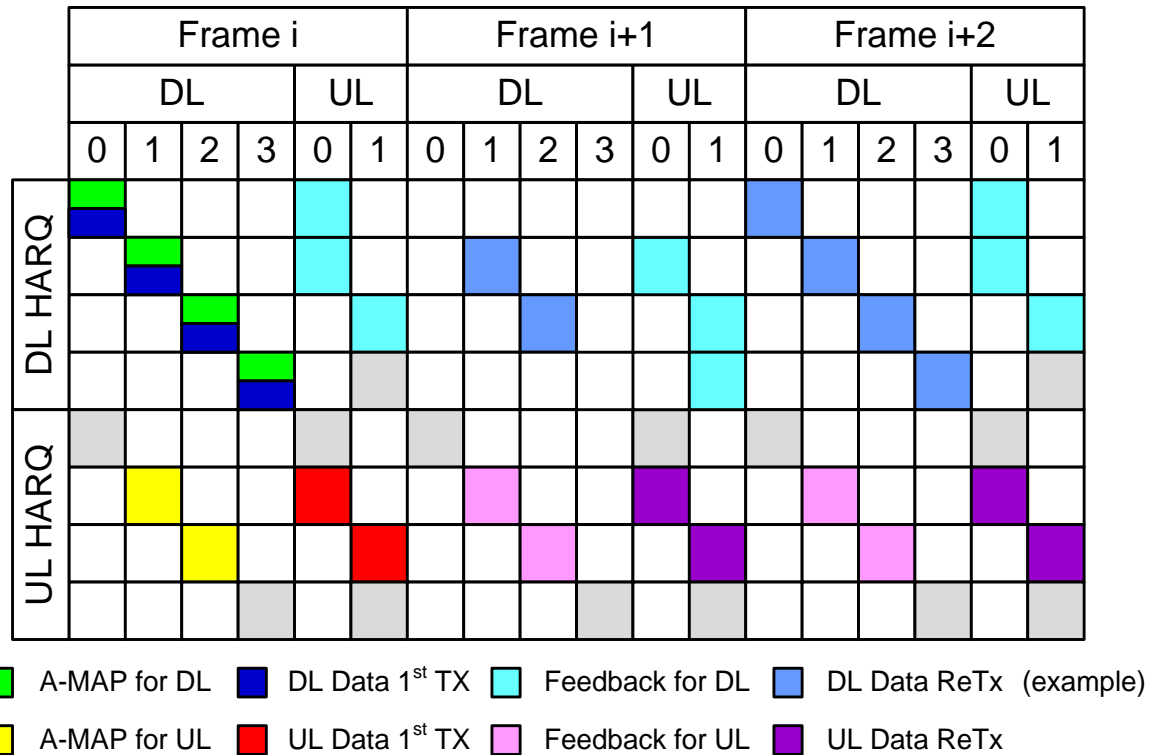

- The timing above provides a time gap of at least 2 subframes for Tx/Rx processing
- The gray-filled square indicates the expected timing but no transmission due to a too short Tx/Rx interval (1 subframe)
- If a longer time gap (3 subframes) should be secured, a slow interlace is applied

A-MAP Tx Period = 2 subframes

5:3 TDD

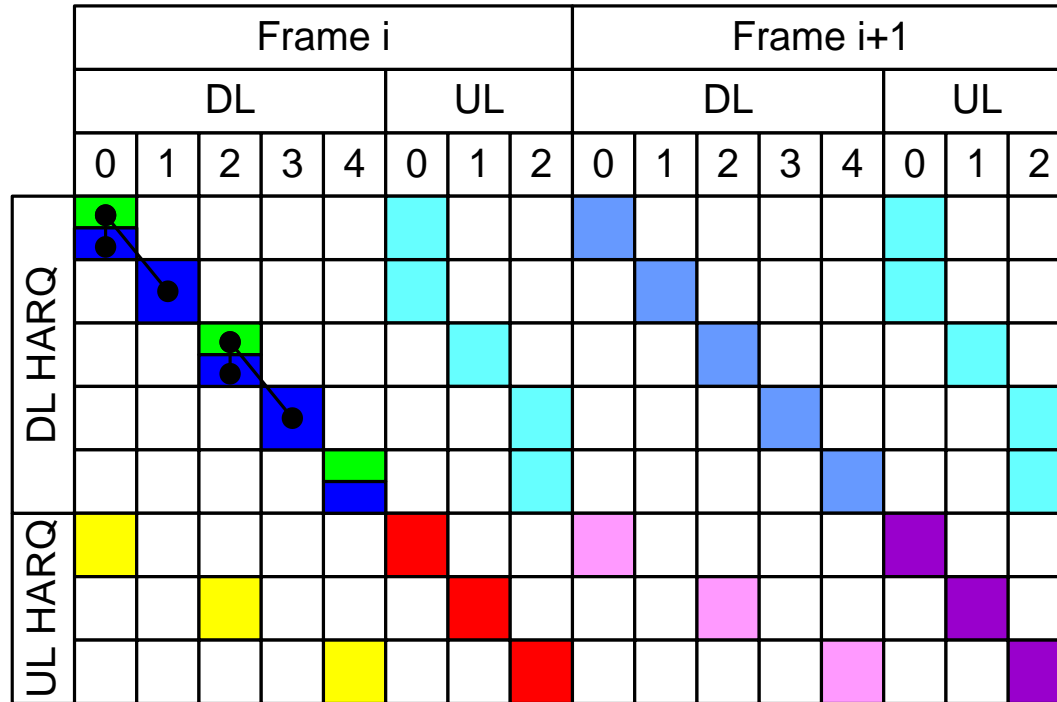

- A-MAP for DL
- DL Data 1st TX
- Feedback for DL
- DL Data ReTx (example)
- A-MAP for UL
- UL Data 1st TX
- Feedback for UL
- UL Data ReTx

- The timing above provides a time gap of at least 2 subframes for Tx/Rx processing
- If a longer time gap (3 subframes) should be secured,
 - DL: a slow interlace is applied to subframe DL4
 - UL: a slow interlace is applied to subframe UL0 and UL2

Long TTI Transmission

- Apply the same equation and rule as the default TTI transmission
 - Subframe index (m) of data transmission indicates the 1st subframe occupied by the long TTI burst
 - The slow feedback/interlace is applied
 - Long TTI size = 4 subframes (FDD), the whole DL/UL subframes (TDD)
- [for more details, see IEEE C802.16m-09/0536]
- Example of HARQ timing for a UL long TTI Tx

