

Project	<b>IEEE 802.20 Working Group on Mobile Broadband Wireless Access</b> < <a href="http://grouper.ieee.org/groups/802/20/">http://grouper.ieee.org/groups/802/20/</a> >	
Title	<b>A Partial Proposal of Rotational OFDM Transmission Scheme</b>	
Date Submitted	<b>2005-10-28</b>	
Source(s)	Toshinori Suzuki Hiroyasu Ishikawa Yasuyuki Hatakawa KDDI R&D Laboratories, Inc. Hikarinooka 7-1, Yokosuka Kanagawa 239-0847	Voice: +81-46-847-6350 Fax: +81-46-847-0947 Email: <a href="mailto:tn-suzuki@kddi.com">tn-suzuki@kddi.com</a> <a href="mailto:hi-ishikawa@kddi.com">hi-ishikawa@kddi.com</a> <a href="mailto:ya-hatakawa@kddi.com">ya-hatakawa@kddi.com</a>
Re:	<b>IEEE 802.20 Working Group Call for Proposals</b>	
Abstract	As a partial proposal, this contribution discusses the rotational OFDM transmission scheme, which improves spectrum efficiency at the multi-path channel by making use of frequency diversity effect. This scheme can be applied to multi-carrier systems such as OFDMA.	
Purpose	To propose a new multi-carrier transmission technology which improves the performance of current multi-carrier based technologies. This technology can be applied or merged to complete system proposals based on TDD or FDD.	
Notice	This document has been prepared to assist the IEEE 802.20 Working Group. It is offered as a basis for discussion and is not binding on the contributing individual(s) or organization(s). The material in this document is subject to change in form and content after further study. The contributor(s) reserve(s) the right to add, amend or withdraw material contained herein.	
Release	The contributor grants a free, irrevocable license to the IEEE to incorporate material contained in this contribution, and any modifications thereof, in the creation of an IEEE Standards publication; to copyright in the IEEE's name any IEEE Standards publication even though it may include portions of this contribution; and at the IEEE's sole discretion to permit others to reproduce in whole or in part the resulting IEEE Standards publication. The contributor also acknowledges and accepts that this contribution may be made public by IEEE 802.20.	
Patent Policy	The contributor is familiar with IEEE patent policy, as outlined in Section 6.3 of the IEEE-SA Standards Board Operations Manual < <a href="http://standards.ieee.org/guides/opman/sect6.html#6.3">http://standards.ieee.org/guides/opman/sect6.html#6.3</a> > and in <i>Understanding Patent Issues During IEEE Standards Development</i> < <a href="http://standards.ieee.org/board/pat/guide.html">http://standards.ieee.org/board/pat/guide.html</a> >.	

### 1 Introduction

In OFDMA, two types of transmissions are generally considered [1-2]. According to [1], there are called block-wise transmission in localized mode and transmission on non-consecutive (scattered) sub-carriers in distributed mode. The later one makes use of frequency diversity, and is recommended for high speed users and/or delay sensitive traffic.

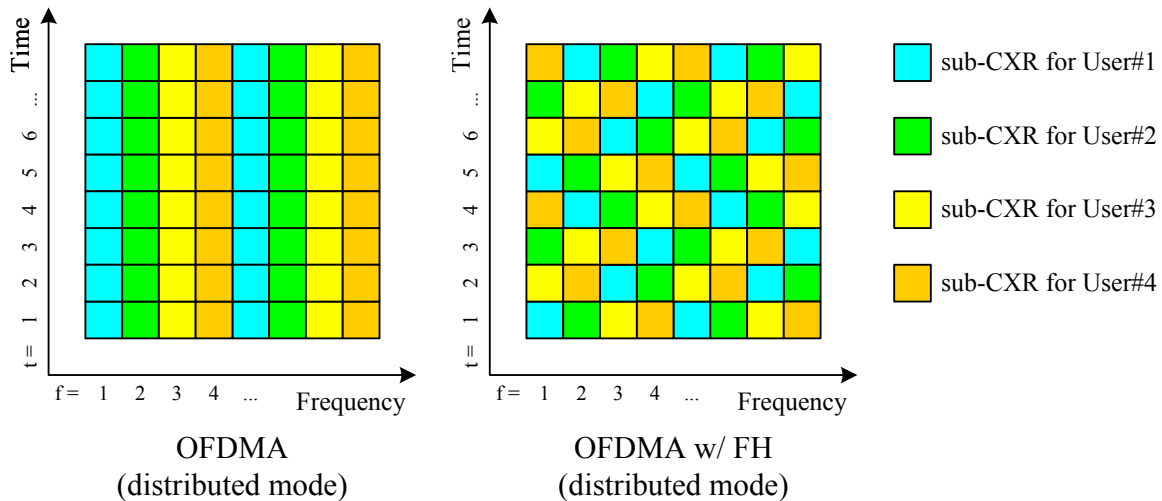

Figure 1: Distributed mode in OFDMA

Originally, OFDM has no frequency diversity effect, but in reality, it obtains the frequency diversity effect by use of FEC. This means that, even in distributed mode, the higher the channel coding rate is, the lower the frequency diversity effect becomes. To compensate this weak point, we present the rotational code-multiplexed OFDM with advanced receiver.

### 2 OFDM Transmission with and without Walsh Code-Multiplexing

#### 2.1 Without Code-Multiplexing

Figure 2 overviews the block diagram for distributed mode, where 2 modulation symbols, A and B, are mapped onto 2 scattered sub-carriers, F1 and F2, respectively. Due to the frequency selective channel, sub-carrier powers are differently received. As a result, there is no frequency diversity effect at the modulation symbols. However, by using the error correction scheme, some frequency diversity is derived, which depends on the coding rate of FEC, though.

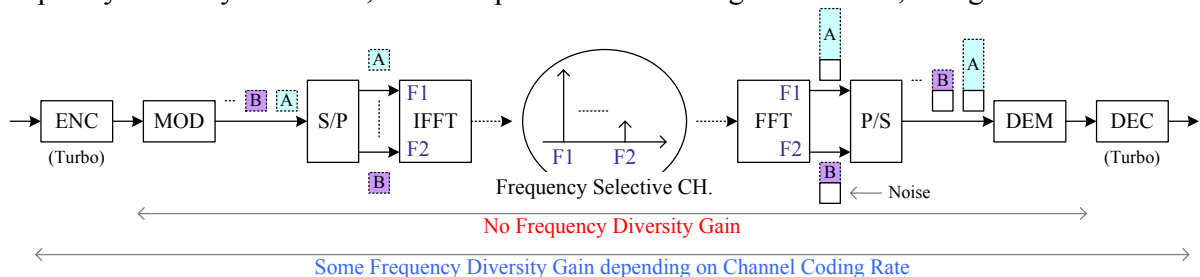

Figure 2: Normal OFDM in distributed mode.

### 2.2 With Walsh Code-Multiplexing

In contrast, OFDM with code-multiplexing, whose diagram is depicted in Figure 3, was expected to obtain the best diversity gain on frequency domain. However, the overall performance with FEC becomes worse than that of OFDM without code-multiplexing mentioned in previous section, because of inter-symbol (or inter-code) interference [3].

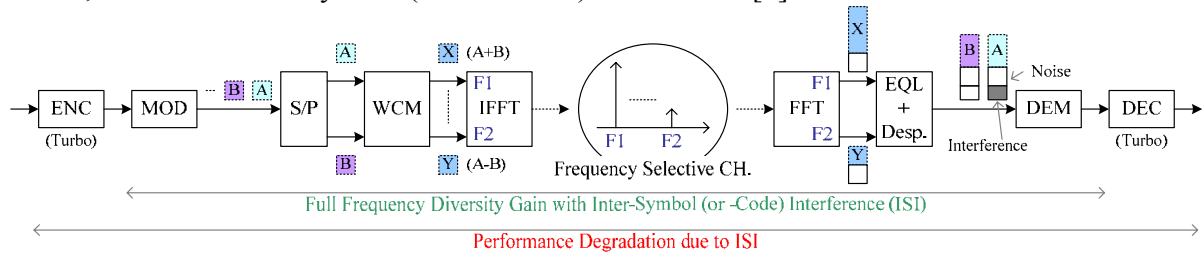

Figure 3: OFDM with Walsh code-multiplexing.

Note that, in Figure 2, WCM means Walsh Code Multiplexing to operate the following formula for 2 dimensions.

$$\begin{pmatrix} X \\ Y \end{pmatrix} = \begin{pmatrix} 1 & 1 \\ 1 & -1 \end{pmatrix} \begin{pmatrix} A \\ B \end{pmatrix} \tag{1}$$

In receiver side, MMSE (Minimum Mean Squared Error) equalization and despreader are used before demodulation.

## 3 Rotational OFDM Transmission

### 3.1 Overview

The rotational OFDM transmission is overviewed in Figure 4. There are three features; the rotational code-multiplexer (RCM), multi-dimensional demodulator (MD-DEM) and dual iteration decoder. In the following, those features are introduced briefly in case of QPSK modulation and 2 dimensional code-multiplexing.

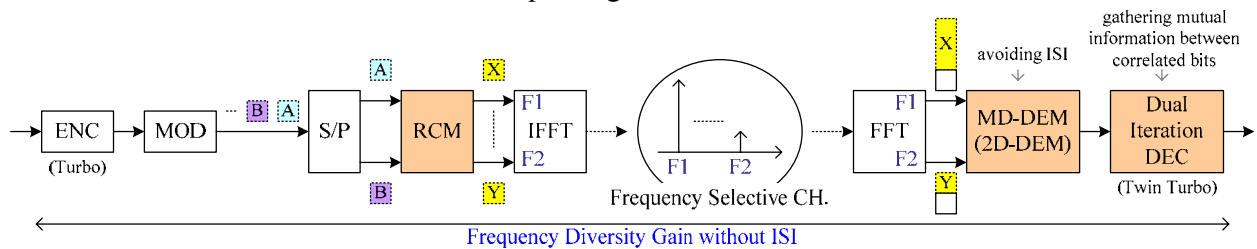

Figure 4: Rotational OFDM (R-OFDM) in distributed mode.

### 3.2 Features in Rotational OFDM Transmission

#### 3.2.1 Rotational Code-Multiplexer (RCM)

RCM converts modulation symbols, A and B, into sub-carrier symbols X and Y, as follows.

$$\begin{pmatrix} X \\ Y \end{pmatrix} = \mathbf{R}_2 \begin{pmatrix} A \\ B \end{pmatrix} = \begin{pmatrix} \cos \theta_1 & \sin \theta_1 \\ -\sin \theta_1 & \cos \theta_1 \end{pmatrix} \begin{pmatrix} A \\ B \end{pmatrix} \quad (2)$$

where  $\theta_1$  is a rotation angle. If  $\theta_1 = 0$ , then the signal becomes the same as that of the normal OFDM without code-multiplexing, as mentioned in section 2.1. On the other hand, when  $\theta_1 = \pi/4$ , the transmission performance is equivalent to that of Walsh code-multiplexed OFDM, as mentioned in section 2.2.

By adjusting the rotation angle, optimum correlation is obtained between modulation symbols A and B, which produces the best frequency diversity. Note that the rotational matrix can be expanded to higher dimensions as follows.

$$\mathbf{R}_4 = \begin{pmatrix} \mathbf{R}_2 \cos \theta_2 & \mathbf{R}_2 \sin \theta_2 \\ -\mathbf{R}_2 \sin \theta_2 & \mathbf{R}_2 \cos \theta_2 \end{pmatrix} \quad (3)$$

Let's assume the QPSK modulation. QPSK symbol consists of I-phase component bit and Q-phase component bit. In this explanation, I-phase bits are paid attention without loss of generality. Let the I-phase bit of modulation symbol A be "a", and that of symbol B be "b". Then, the signal constellation constructed by I-phase channels on F1 and F2 is as shown in Figure 4. At the constellation, the minimum distance between signals, such as the distance between "00" and "01", dominates the transmission performance. Rotating the constellation by  $\pi/4$  ( $\theta_1 = \pi/4$ ), makes the minimum distance stable against the Rayleigh fading, due to 2-branch (2-sub-carriers) diversity. However, the diagonal distance, such as in-between "00" and "11", tends to fluctuate by  $\pi/4$  rotation, due to loss of 2-branch diversity. Although the diagonal distance is longer than the minimum distance for 3dB, that drawback is not negligible with FEC. Therefore, optimum rotation angle exists between 0 and  $\pi/4$ .

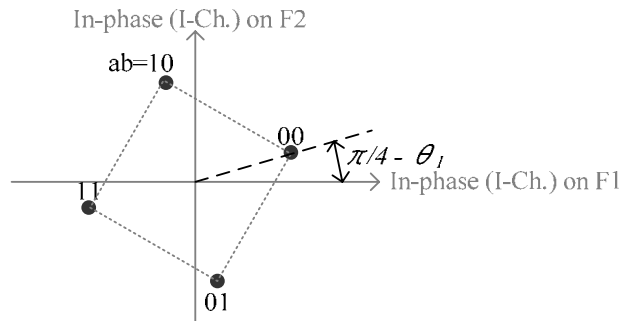

Figure 5: Signal Constellation at Transmitter Side.

### 3.2.2 Multi-Dimensional Demodulator (MD-DEM)

Because of the frequency selectivity, signal constellation of Figure 5 is generally distorted as shown in Figure 6. The conventional receiver uses MMSE equalization and despreading, as shown in Figure 3, which brings inter-symbol (or inter-code) interference (ISI). To avoid the ISI, multi-dimensional demodulator is used here, detecting the likelihood of the code-multiplexed symbol, as shown in Figure 6.

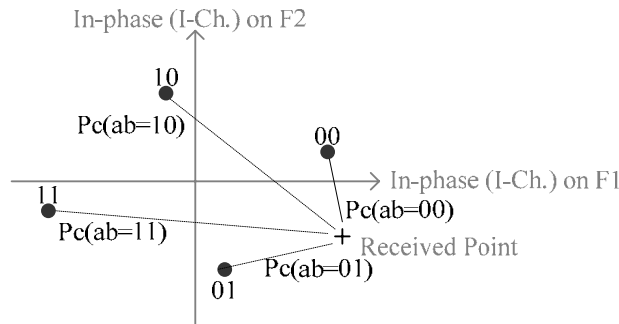

Figure 6: Signal Constellation and the Symbol Likelihood at Receiver Side.

### 3.2.3 Dual Iteration Decoder (Twin Turbo Decoder)

In general, MAP decoding assumes no correlation between inputted soft decisions as well as Viterbi decoding. Therefore, for correlated signals, their mutual information is discarded in conventional decoder. In order to take it in, Twin Turbo Decoder [4] seems appropriate for this rotational OFDM. Figure 7 shows the overview of the twin turbo decoder. In addition to the conventional feedback loop for “Brief Propagation”, there is a 2<sup>nd</sup> feedback loop for “Brief Coupling”. In this decoder, soft decisions are updated during Turbo decoding.

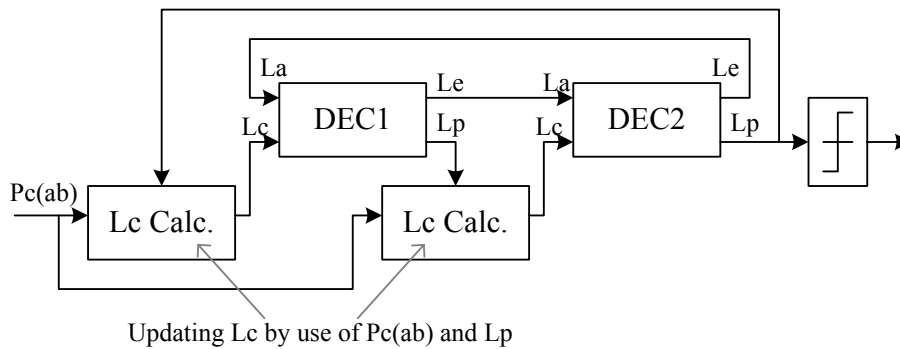

Figure 7: Twin Turbo Decoder.

## 3.3 Performance Evaluation

### 3.3.1 Simulation Assumption

Table 1 lists the simulation parameters. In this simulation, one user frame occupies whole sub-carriers. Code-multiplexed symbols (X and Y in Figure 4) are randomly assigned to sub-carriers. For Walsh code-multiplexed OFDM, the despreader with MMSE equalizer was assumed.

Table 1. Simulation Parameters

Occupied Bandwidth $W$	5.0 MHz
Sampling rate $t_s$ ( $= 1 / W$ )	0.2 $\mu$ sec.
# of sub-carriers	512
Data symbol duration	102.4 $\mu$ sec.
CP duration	11.2 $\mu$ sec.
# of info.bits / frame (incl. tail bits)	1024 ( $R = 1/2$ ), 3072 ( $R = 3/4$ )
Frame length	1 OFDM symbol ( $R = 1/2$ & 16QAM), 2 OFDM symbols ( $R = 1/2$ & QPSK, $R = 3/4$ & 16QAM), 4 OFDM symbols ( $R = 3/4$ & QPSK)
Channel coding	Turbo code ( $K = 4$ )
Coding rate ( $= R$ )	1/2, 3/4
Decoding algorithm	Max Log-MAP / 8 iterations
Modulation	QPSK, 16QAM
Rotation dimension ( $= D$ )	2, 4
Rotation angle for rotational OFDM	$\theta_1, \theta_2 = 0.3 \sim 0.7 \pi/4$
Channel model	Pedestrian B (3 km/h), Vehicular B (30 km/h) [6]
# of receiving antenna	1
Channel estimation	Ideal

### 3.3.2 Simulation Results

In this simulation, 2 kinds of OFDM transmission are taken into account for distributed mode. As normal OFDM transmissions, there are no code-multiplexing OFDM mentioned in section 2.1. For the rotational OFDM transmission scheme, 2 dimensions and 4 dimensions were assumed. Figure 8 and 9 compare the FER performances among 2 OFDM schemes in case of QPSK modulation. When the coding rate is higher, rotational OFDM becomes better than normal ones. Figure 10 and 11 are for 16QAM cases. Although the gain of rotational OFDM scheme decreases, significant gains have been confirmed.

## 4 Conclusion

In this contribution, we presented a rotational OFDM transmission scheme for distributed mode. By using the RCM (Rotational Code Multiplexing) and advanced detection, frequency diversity gain increases, especially in case of higher channel coding rate. It should also be noted that the RCM is a parameterized function which contains normal OFDM scheme with no rotation angle. With this scheme, spectrum efficiency can be significantly improved for distributed mode in OFDMA.

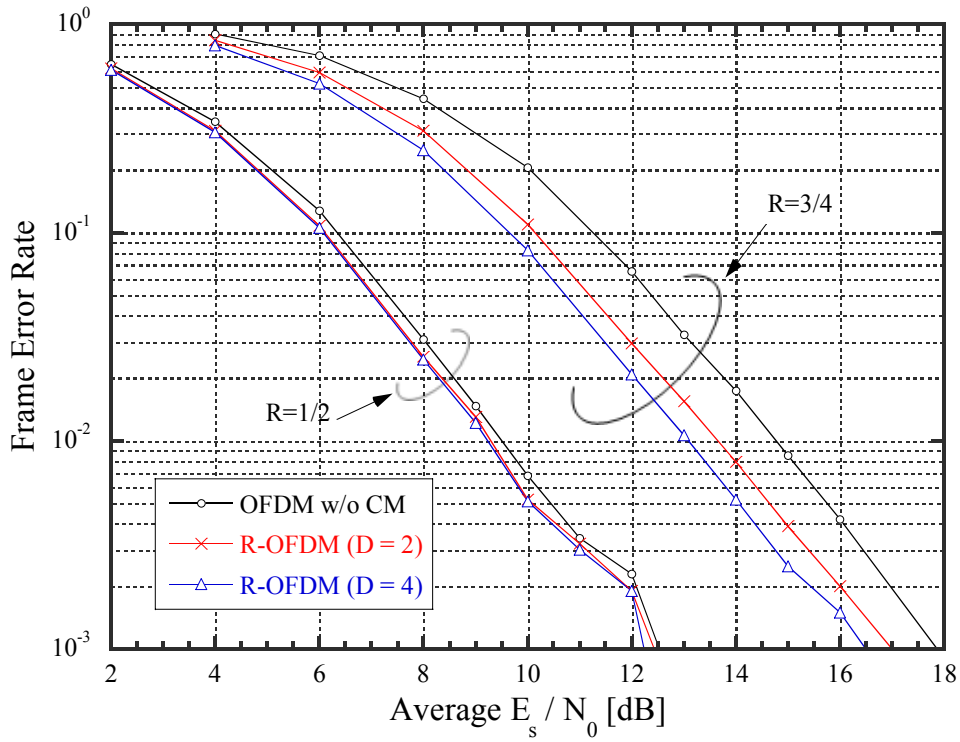

Figure 8: Frame Error Rates (QPSK in Pedestrian B channel).

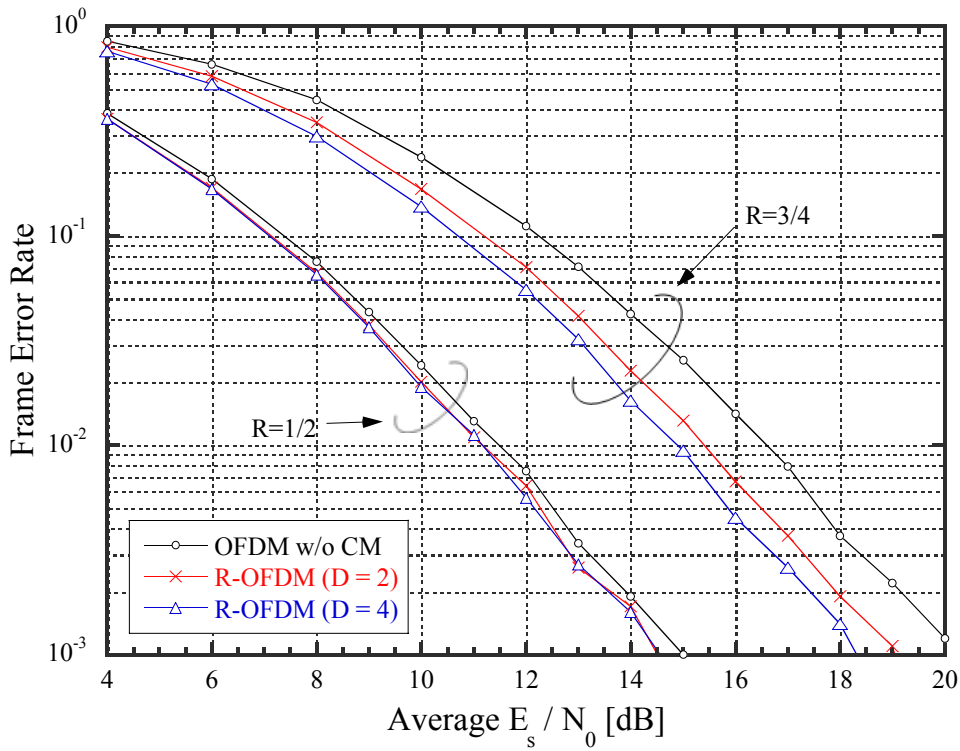

Figure 9: Frame Error Rates (QPSK in Vehicular B channel).

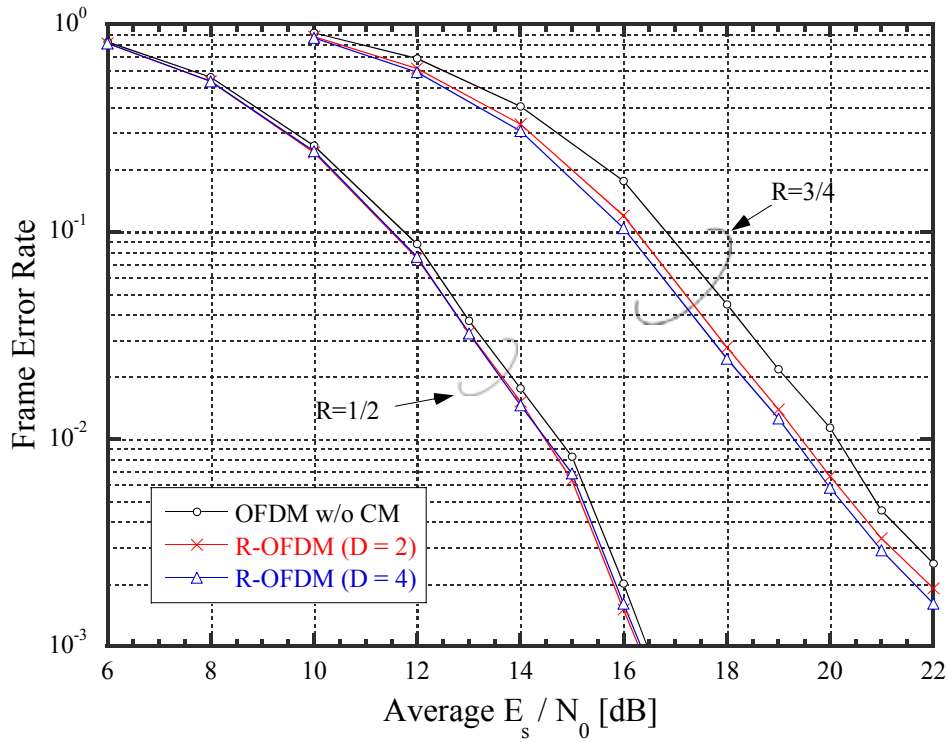

Figure 10: Frame Error Rates (16QAM in Pedestrian B channel).

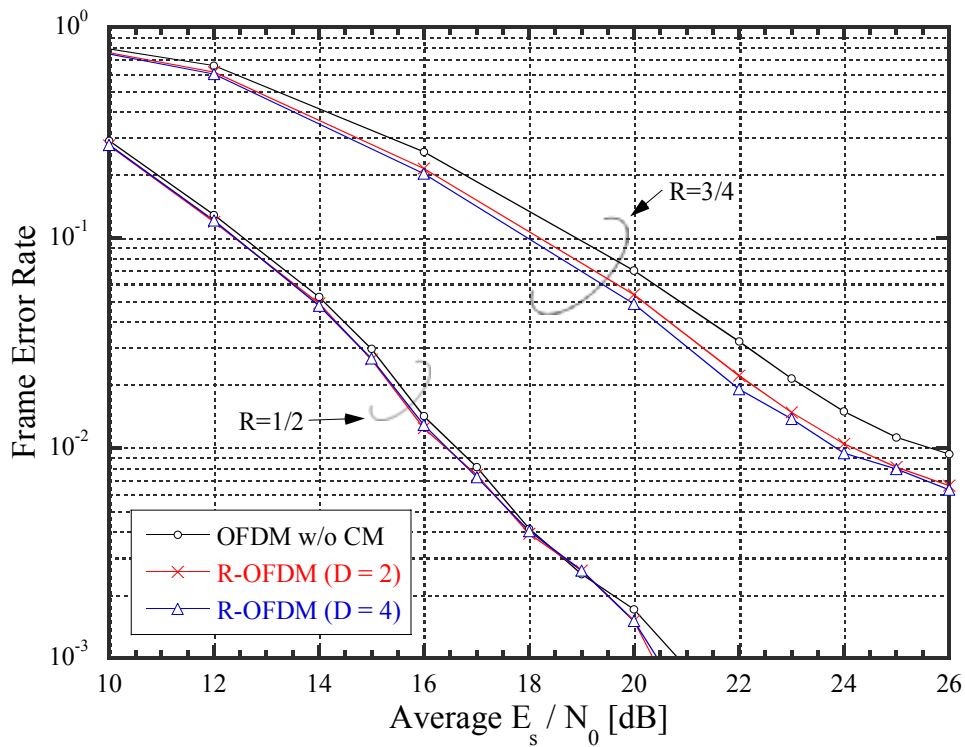

Figure 11: Frame Error Rates (16QAM in Vehicular B channel).



**References**

- [1] 3GPP TR 25.814 V0.2.1, "Physical Layer Aspects for Evolved UTRA (Release 7)", Sept. 2005.
- [2] IEEE P802.16e/D10, " IEEE Standard for Local and Metropolitan Area Networks Part 16: Air Interface for Fixed Broadband Wireless Access Networks, Amendment for Physical and Medium Access Control Layers for Combined Fixed and Mobile Operation in Licensed Bands", Aug. 2005.
- [3] D. Garg and F. Adachi, "Diversity-Coding-Orthogonality Trade-off for Coded MC-CDMA with High Level Modulation", IEICE Trans. on COM, Vol. E88-B, Jan. 2005.
- [4] T. Suzuki et.al., "A Proposal of Twin Turbo Detector and Its Evaluation for M-QAM OFDM", Proc. of 2005 IEICE Society Conference, B-5-6, Sept. 2005.
- [5] J. Boutros and E. Viterbo, " Signal space diversity: a power and bandwidth efficient diversity technique for the Rayleigh fading channel", IEEE Trans. Inform. Theory, vol.44, no.4, pp.1453-1467, July 1998.
- [6] ITU-RM.1225, "Guidelines for Evaluation of Radio Transmission Technologies for IMT-2000," 1997.

## Annex 1

### System Requirements Document Compliance Table

#	Requirement	SRD Section #	Requirement Type		Compliance Level	
			Shall	Should	Yes	Notes
1	PAR requirements	1.3	•		•	Only for physical layer
4	non-line of sight outdoor to indoor scenarios and indoor coverage	3.1	•		•	Note 1
6	Spectral efficiency – DL @ 3 km/hr: 2.0b/s/Hz/sector	4.1.1	•		•	Note 1
7	Spectral efficiency – DL @ 120km/hr: 1.5b/s/Hz/sector	4.1.1	•		•	Note 1
8	Spectral efficiency – UL @ 3km/hr: 1.0b/s/Hz/sector	4.1.1	•		•	Note 1
9	Spectral efficiency – UL @ 120km/hr: .75b/s/Hz/sector	4.1.1	•		•	Note 1
10	Block assignment support	4.1.2	•		•	Note 1
11	Duplexing Scheme	4.1.3	•		•	<i>Both FDD and TDD scheme are supported.</i>

#	Requirement	SRD Section #	Requirement Type		Compliance Level	
			Shall	Should	Yes	Notes
12	Support for Half Duplex FDD subscriber station.	4.1.3	●		●	Note 1
13	Support for different mobility rates	4.1.4	●		●	Note 1
14	Aggregated data rate consistent with item 6	4.1.5	●		●	Note 1
15	Aggregated data rate consistent with item 7	4.1.5	●		●	Note 1
16	Aggregated data rate consistent with item 8	4.1.5	●		●	Note 1
17	Aggregated data rate consistent with item 9	4.1.5	●		●	Note 1
18	Peak User Data Rate (DL) of 4.5 Mbps in 1.5 MHz	4.16	●		●	Note 1
19	Peak User Data Rate (UL) of 2.25 Mbps in 1.25 MHz	4.16	●		●	Note 1
20	Peak User Data Rate (DL) of 18 Mbps in 5.0 MHz	4.16	●		●	Note 1
21	Peak User Data Rate (UL) of 9 Mbps in 5.0 MHz	4.16	●		●	Note 1
25	MAC/PHY features to support multi-antenna	4.1.9	●		●	Note 1

#	Requirement	SRD Section #	Requirement Type		Compliance Level	
			Shall	Should	Yes	Notes
	capabilities at the BS					
26	Base station antenna diversity	4.1.10	•		•	Note 1
27	Support coverage enhancing technologies	4.1.11	•		•	Note 1
36	automatic selection of optimized user data rates that are consistent with the RF environment constraints and application requirements	4.2.1	•		•	Note 1
37	Graceful reduction or increase of user data rates, on the downlink and uplink	4.2.1	•		•	Note 1
38	Link adaptation	4.2.1	•		•	Note 1
40	Application in dense urban, urban, suburban, rural, outdoor-indoor, pedestrian, and vehicular environments and the relevant channel models.	4.2.2	•		•	Note 1
41	Physical layer Measurements - BS	4.2.4	•		•	Note 1
42	Physical layer Measurements -	4.2.4	•		•	Note 1

#	Requirement	SRD Section #	Requirement Type		Compliance Level	
			Shall	Should	Yes	Notes
	MS					
43	Design extensible to wider channels.	4.3	•		•	Note 1

Note 1: The Rotational OFDM will be a supplement to the complete system and shall be compliant to the requirement item while the complete system complies with the requirement.