

# Coexistence Lessons Learned

Date: 2014-11-08

## Authors:

Name	Company	Address	Phone	E-mail
Paul Nikolich	IEEE 802 Chair	Montclair NJ	+1-857-205-0050	p.nikolich@ieee.org
Steve Shellhammer	Qualcomm	5775 Morehouse Dr San Diego, CA 92121	+1-858-658-1874	shellhammer@ieee.org
Stanislav Filin	NICT			sfilin@nict.go.jp
Andrew Myles	Cisco Systems	Australia	+61 2 84461010	amyles@cisco.com
Peter Ecclesine	Cisco Systems	170 W. Tasman Dr. San Jose, CA 95134	+1-408-527-0815	pecclesi@cisco.com
Apurva N. Mody	WhiteSpace Alliance and BAE Systems		+1-404-819-0314	apurva.mody@baesystems.com Apurva.mody@WhiteSpaceAlliance.org
Vinko Erceg	Broadcom		+1-858-521-5884	verceg@broadcom.com

# IEEE 802 Approved Presentation

**This presentation was developed by IEEE Project 802<sup>®</sup>, the Local and Metropolitan Area Network Standards Committee (“IEEE 802”), an international standards development committee organized under the IEEE and the IEEE Standards Association (“IEEE-SA”).**

**The content herein was approved by the IEEE 802 Executive Committee, in accordance with the IEEE 802 policies and procedures, and represents the view of IEEE 802.**

# IEEE 802 Standards and Working Group Documents

- **References are made to both IEEE 802 standards and 802 working documents**
- **IEEE 802 standards are available for free, 6 months after publication, under the IEEE Get program at:**
  - <http://standards.ieee.org/about/get/>
- **IEEE 802 working documents (except draft standards) are available on the IEEE 802 Mentor web site**
  - <https://mentor.ieee.org/802/bp/StartPage>

# Presentation Outline

- **Part 1 – Let’s Work Together**
- **Part 2 – Lessons Learned**
  - IEEE 802.11
  - IEEE 802.15.2
  - IEEE 802.16h
  - IEEE 802.22
  - IEEE 802.19.1
- **Part 3 – Backup**
  - Coexistence History in IEEE 802
  - Coexistence Scenarios and Metrics
  - Examples of Coexistence Assurance Documents
  - Coexistence Mechanisms: IEEE 802.11, 802.15.2, 802.16h, and 802.22
  - Overview of 802.19.1 Standard for TVWS Coexistence
  - IEEE 802 Coexistence Process
  - References

# Part 1 – Let's Work Together

# **IEEE 802 wants to work with 3GPP on fair sharing mechanisms, based on a shared view of their importance**

- **Fair sharing mechanisms are vital to anyone making use of 802.11 systems**
- **Fair sharing mechanisms are also vital for many operators making use of 3GPP technology**
- **3GPP has identified fair sharing with 802.11 systems as the key challenge for LAA development**
- **3GPP has identified a reasonable initial definition of fair sharing**
- **Listen Before Talk (LBT) provides a useful starting point for fair sharing discussions between 3GPP and IEEE 802**
- **IEEE 802 wants to work with 3GPP to achieve consensus on fair sharing mechanisms for 802.11 and LAA**

# **Fair sharing mechanisms are vital to anyone making use of 802.11 systems**

- **The success of unlicensed spectrum (2.4 and 5 GHz) has been underpinned by the use of fair sharing mechanisms**
  - 802.11 coexistence mechanism make use of energy detect (ED) at high thresholds and carrier sense (CS) at lower thresholds
- **There are billions of 802.11 devices that make use of these mechanisms**
- **New 802.11 devices are increasingly being deployed in 5 GHz spectrum to satisfy a wide variety of important use cases**
- **These 802.11 devices will be adversely affected by another system that does not support fair sharing mechanisms**
- **Equally, other systems would be adversely affected if 802.11 devices stopped using fair sharing mechanisms**

# Fair sharing mechanisms are also vital for many operators making use of 3GPP technology

- Many 3GPP operators today currently leverage the benefits of 802.11 and want to continue to do so in the future
- The market and regulators have an expectation of fair sharing between LAA and 802.11, and will expect that LAA will not diminish the ongoing and expanded use of 802.11 in the 5 GHz band
- Indeed, 3GPP's doc. RP-141664 recognizes that, ... *it is not enough to minimize interference simply for regulatory aspects. It is also essential to insure that a deployed system will operate as a "good neighbor"*



## **3GPP has identified fair sharing with 802.11 systems as the key challenge for LAA development**

- **3GPP doc. RP-141664 has identified the importance of fairness and defined fairness in the context of LAA and 802.11 as follows:**
  - *Identify and define design targets for coexistence with other unlicensed spectrum deployments, including fairness with respect to Wi-Fi and other LAA services*
- **IEEE 802 agrees that fairness is vital for successful sharing of unlicensed spectrum between LAA and 802.11**
- **Fairness is in “the eye of the beholder” and so the challenge for 3GPP and IEEE 802 is to agree on a definition of fairness**
- **The IEEE 802 notes this challenge could also be applied to sharing between LAA and other systems**

# 3GPP has identified a reasonable initial definition of fair sharing

- **3GPP doc. RP-141664 has highlighted a potential definition of fair sharing of spectrum between LAA and 802.11**
  - *This should be captured in terms of relevant fair sharing metrics, e.g., that LAA should not impact Wi-Fi services (data, video and voice services) more than an additional Wi-Fi network on the same carrier; these metrics could include throughput, latency, jitter etc.*
- **IEEE 802 supports this conceptual definition of fair sharing as the basis for further discussion between 3GPP and IEEE 802**
- **This definition effectively treats LAA and 802.11 as having equal standing in access to the spectrum, which is aligned with the intent of the regulatory authorities in most countries**
- **Detailed system-level simulation scenarios will need to be specified that incorporate the throughput, latency and jitter metrics**

## **Listen Before Talk (LBT) provides a useful starting point for fair sharing discussions between 3GPP and IEEE 802**

- **3GPP doc. RP-141664 highlights the use of LBT as a coexistence mechanism that is often used to achieve fair sharing**
  - *In some regions in the world, unlicensed technologies need to abide to certain regulations, e.g. Listen-Before-Talk (LBT). Fair coexistence between LTE and other technologies such as Wi-Fi as well as between LTE operators is seen necessary.*
- **IEEE 802 notes that LBT has a long history of success in promoting fair sharing between non-coordinated systems in unlicensed spectrum and has wide acceptance as a coexistence mechanism from regulators**
- **IEEE 802 supports using the LBT coexistence mechanism as a useful starting point for fair sharing between LAA and 802.11, particularly as it is required by regulations in Europe**
- **IEEE 802 acknowledges that there may be other coexistence mechanisms for fair sharing between LAA and 802.11, and is willing to discuss them as they are proposed**

# **IEEE 802 wants to work with 3GPP to achieve consensus on 802.11/LAA sharing**

- **IEEE 802 would like the opportunity to review the 3GPP coexistence simulation studies related to LAA and 802.11 and provide feedback**
- **IEEE 802 would also like to review a range of documents throughout the period of the study item**
- **Examples of information that IEEE 802 is interested in reviewing include,**
  - The SI schedule as it develops
  - Details of the fairness criteria
  - The simulation scenarios
  - The LBT related parameters
  - The simulation methodology
  - Other coexistence mechanisms for fair sharing
- **Our goal is for IEEE 802 and 3GPP to build towards a consensus on the best way for LAA to fairly share the same spectrum with 802.11 systems**

# Part 2 – Lessons Learned

## **The lessons learned are highly dependent on the circumstances of the system and environment**

### **Lessons learned**

- **802.11: CSMA/CA is better suited to sharing unlicensed spectrum than TDMA-like systems**
- **802.15.2: Adaptive Frequency Hopping is an effective mechanism for sharing with 802.11**
- **802.16h: it is challenging to make scheduled systems, like 802.16h, compatible with 802.11 systems**
- **802.22: unique characteristics of TVWS allow spectrum etiquette using database access**
- **802.19.1: it is possible to leverage the capabilities of the TVWS devices to enhance coexistence**

## **IEEE 802.11 CSMA/CA is better suited to sharing unlicensed spectrum than TDMA-like systems**

- **CSMA/CA works in ISM bands (such as 2.4 and 5.8 GHz band) where there is uncontrolled energy in the band**
- **IEEE 802.11 attempted to use TDMA-like systems (PCF and HCCA), and they have failed in the marketplace for a variety of reasons**
  - It is impractical to coordinate access between low-cost independent systems, particularly for mobile devices moving across networks
  - The performance provided by CSMA/CA has proven by its wide adoption in the marketplace to be good enough for the vast majority of use cases
- **License-exempt wireless systems cannot rely on the guaranteed reception of radio management and control traffic**

## **IEEE 802.15.2 Adaptive Frequency Hopping is an effective mechanism for coexistence with 802.11**

- **IEEE 802.15.2 [2] standardizes coexistence methods for IEEE 802.15.1 (Bluetooth) with other wireless systems in the 2.4 GHz frequency band**
- **Multiple coexistence techniques are included in IEEE 802.15.2 to enable 802.15.1 to coexist with 802.11**
  - Several tables are provided in the backup slides giving a brief overview of these mechanisms
- **One of the most powerful coexistence mechanisms included is adaptive frequency hopping (AFH) in which 802.15.1 “hops over” a nearby 802.11 WLAN**
  - AFH has shown to be very effective
  - AFH was subsequently integrated into the Bluetooth specification



## **IEEE 802.16h: defines the use of 802.16 systems in shared licensed-exempt spectrum**

- **IEEE 802.16 as most commonly deployed is time-division duplex (TDD) system based on Orthogonal Frequency Division Multiple Access (OFDMA)**
- **IEEE 802.16h [4] is an amendment to the 802.16 standard on “Improved Coexistence Mechanisms for License-Exempt Operation”**
- **One band considered for 802.16h operation is the 3650-3700 MHz band, also considered for 802.11y operation**
- **During the development of 802.16h a coexistence assurance document [5] was developed which studied the coexistence of 802.16h and 802.11y**

## **IEEE 802.16h: it is challenging to make scheduled systems, like 802.16h, compatible with 802.11 systems**

- **Note: Of all the 802 systems, 802.16h is the closest analog to LTE in unlicensed bands**
- **The time-synchronization requirements of 802.16h systems are incompatible with deployed 802.11 systems**
- **Coordination access required a high-cost high-speed control channel between 802.16h and 802.11 systems, which may be impractical**
- **Coordination of policy between 802.16h and multiple 802.11 systems is challenging since 802.11 systems are often independently managed**

# IEEE 802.22 Defines a WRAN in the TV White Space

- **IEEE 802.22 is a wireless regional area network (WRAN) standard for operation in the TVWS**
- **Two or more WRAN networks may be running in the same area and be managed by different operators**
- **Two coexistence mechanisms are included in the standard**
  - *Spectrum etiquette* is used to select orthogonal primary and secondary channels when sufficient channels are available
  - *Frame-based on-demand spectrum contention* is used when a single TVWS channel must be shared
- **Additional detail is provided in the backup slides**

## **IEEE 802.22: Unique characteristics of TVWS allow spectrum etiquette using database access**

- **In the TVWS there are special requirements for geo-location and database access in a master device within the network**
- **In the TVWS these capabilities can be combined with an external database to enable coexistence, however, there has not yet been sufficient deployment in the TVWS to require any coexistence solutions beyond the spectrum etiquette**
- **A definition of fairness is necessary in order to design a fair coexistence mechanism**

## **IEEE 802.19.1: It is possible to leverage the capabilities of TVWS devices to enhance coexistence**

- **With the FCC and other regulatory agencies opening up unused TV white space spectrum for unlicensed use multiple protocols may be standardized for TVWS operation**
- **The IEEE took a proactive step to address TVWS coexistence by developing a standard**
- **The standard utilizes two unique capabilities of TVWS networks**
  - Location awareness
  - Access to geo-location database
- **An overview of the 802.19.1 standard is given in the backup**

# **Part 3 – Backup**

# **IEEE 802 has a long history of dealing with coexistence issues**

- **Appendix F in 802.11-1997 standard addresses coexistence of frequency hopping and direct sequence in the 2.4 GHz band**
- **The 802.15 working group was established in July 1999**
  - Both 802.11b and 802.15.1 operate in the 2.4 GHz ISM band
- **IEEE 802 formed 802.15 task group 2 on the coexistence of 802.11 and 802.15.1 in March 2000**
- **IEEE 802.15.2 was published in 2003**
  - Adaptive Frequency Hopping was later incorporated in to Bluetooth Specification

## IEEE 802 has a long history of dealing with coexistence issues

Years	Coexistence Work
1997	IEEE 802.11 Appendix F addressing coexistence of frequency hopping and direct sequence systems in 2.4 GHz band
2002	Formation of IEEE 802.19
2003	IEEE 802.15.2 Recommended Practice on Coexistence of WPAN devices with other devices in Unlicensed Frequency Bands
2006 – Present	Coexistence Assurance (CA) Documents <ul style="list-style-type: none"><li>• IEEE 802.11 – Six CA documents</li><li>• IEEE 802.15 – Twelve CA documents</li><li>• IEEE 802.16 – One CA document</li></ul>
To Present	General coexistence methods and self coexistence methods in MAC/PHY standards <ul style="list-style-type: none"><li>• 802.11, 802.15 802.16h and 802.22</li></ul>
2014	IEEE 802.19.1 Standard on TVWS Coexistence Methods



# **IEEE 802.19 reviews coexistence assurance documents from the working groups**

- **In 2002, IEEE 802 established a technical advisory group (TAG) on wireless coexistence, outside of the individual wireless working groups, which would operate at the 802 level.**
- **IEEE 802 developed rules on coexistence for new projects in 2004**
  - When a new project is proposed to the IEEE 802 Executive Committee the working group is required to state if the working group will develop a Coexistence Assurance (CA) document along with the draft standard
  - If the WG commits to developing a CA document, then the WG is required to produce a CA document which is to be reviewed by the WG and 802.19 during WG letter ballot
- **Around 20 CA documents have been reviewed**
- **Details of the process provided in subsequent slides**

# **IEEE 802.19.1 is a standard for coexistence in the TV white space**

- **In 2009 a new project was initiated focusing on coexistence in the TV white space (TVWS)**
- **This standard leverages the inherent cognitive capabilities of TVWS devices including location awareness and ability to access on-line databases**
- **The 802.19.1 standard was published in 2014**

# Evaluation of coexistence must consider various scenarios and metrics

- **Coexistence Scenarios - Specify Network Parameters of the two (or more) networks**
  - Number of network devices
  - Location of each of the network devices
    - Deterministic Geometry or Stochastic Geometry
  - Transmit power of the network devices
  - Bandwidth and center frequency of network devices
  - Statistics of channel occupancy of each of the networks
  - Statistics of data traffic on each of the networks
  - Protocol parameters
    - Some are specified in standard, like carrier sense threshold
    - Some are implementation specific, like rate adaptation algorithm

## Description of a coexistence scenario involves specification of network geometries

- In an unlicensed band the user may not be able to control the physical separation of devices of the two different networks
- Specify geometry as a function of the separation ( $d$ )
- Evaluate coexistence metrics as a function of the separation ( $d$ )
- Primary interference is between WLAN STA and WPAN Node 1

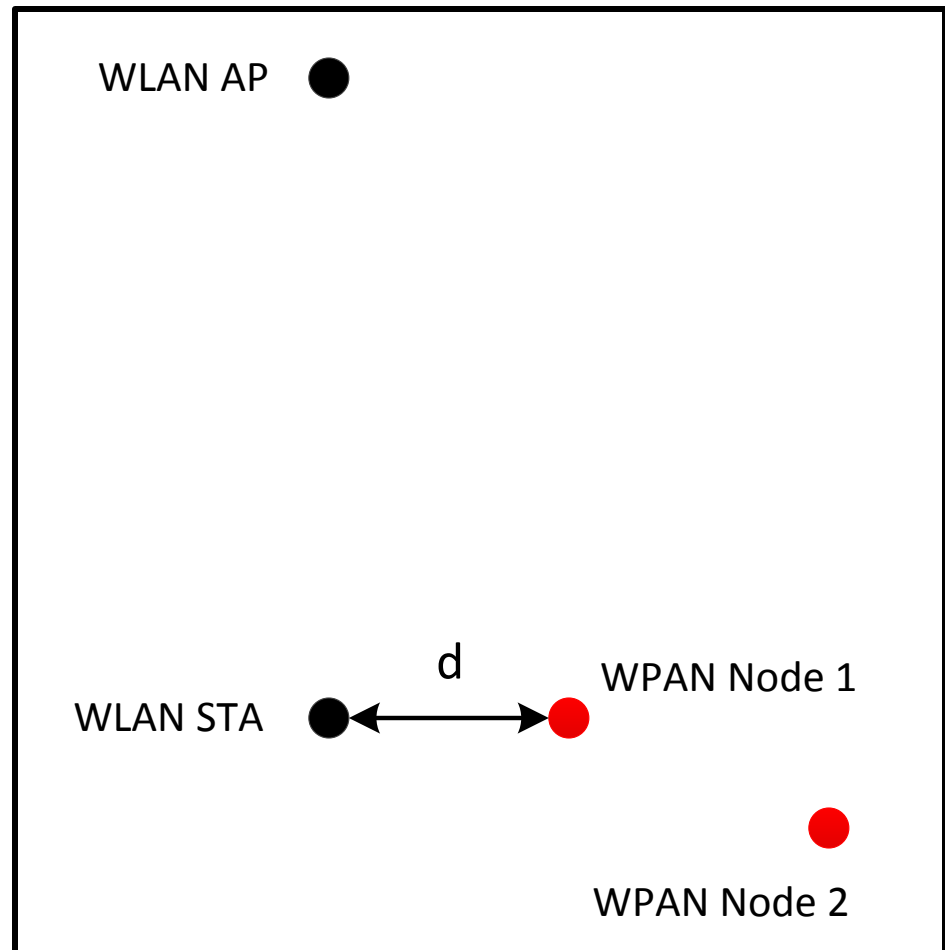

# **The network geometries can be specified stochastically**

- **Randomly place devices from each network in a given region with a specified density**
- **Placement of Base Stations or Access Points depend on how those devices are deployed (by operator or consumer)**
- **Evaluate coexistence metrics as function of the density of the two networks, which may have different densities**

# Coexistence Metrics

- **There are a number of coexistence metrics that can be studied when evaluating the coexistence of two networks. Typically these are network performance metrics. Examples include,**
  - Network Throughput (e.g. median and 10<sup>th</sup> percentile)
  - Network Latency (e.g. median and 90<sup>th</sup> percentile)
  - Packet Error Rate

# Examples from Coexistence Assurance Documents

- **Around 20 coexistence assurance documents have been developed in IEEE 802 to show how well new standards coexist with current standards**
- **These documents are available on the web at,**
  - <http://grouper.ieee.org/groups/802/19/pub/ca.htm>
- **One nice example is the CA document for 802.15.4k which specifies several PHYs for Low Energy, Critical Infrastructure Monitoring Networks (LECIM)**

## **Example CA Document: 802.15.4k CA Doc**

- **IEEE 802.15.4k supports multiple frequency bands**
- **The CA document summarizes which other systems operate in these bands**
- **The CA document specifies a fixed geometry of the victim network and varies the interference level, based on distance between interferer and victim node and path loss model**
- **Simulations of co-channel interference are performed**
  - Plotted bit error rate (BER) and Frame error rate (FER) versus distance between interferer and victim
- **Considered both 802.15.4k interference on other systems and interference of other systems on 802.15.4k**



# IEEE 802.11 Coexistence Mechanisms

- **The IEEE 802.11 MAC is based on a carrier sense multiple access (CSMA) technology**
- **IEEE 802.11 CSMA include two sensing techniques:**
  - Carrier Sense for 802.11 Frames
  - Energy Detection for other systems
- **The threshold for energy detection is typically set at a higher power level than 802.11 Frame detection since energy detection at very low power levels is typically unreliable**
- **Clause 18 of the 802.11 standard [1] specifies the energy detection threshold limits for the OFDM PHY**

Channel Bandwidth	ED Threshold Limit	CS Threshold Limit
20 MHz	ED_Thresh $\leq$ -62 dBm	CS_Thresh $\leq$ -82 dBm
10 MHz	ED_Thresh $\leq$ -65 dBm	CS_Thresh $\leq$ -85 dBm
5 MHz	ED_Thresh $\leq$ -68 dBm	CS_Thresh $\leq$ -88 dBm

## **IEEE 802.15.2 Coexistence Mechanisms**

- **IEEE 802.15.2 was developed to address the coexistence of IEEE 802.11 and 802.15.1 (Bluetooth)**
- **A number of coexistence mechanism are included in the standard. A table is provides on the next few slides**
- **One of the primary mechanisms, adaptive frequency hopping (AFH), was later adopted in the Bluetooth specification**
- **Additional information about coexistence mechanisms including simulation results available in [2]**

# IEEE 802.15.2 Coexistence Mechanisms

Coexistence Mechanism	Description
Alternative Wireless Medium Access (AWMA)	A time division multiplexing scheme to be used when 802.15.1 master is collocated in the same devices as one of the 802.11 STAs. Since 802.15.1 slaves transmissions are set by 802.15.1 master no changes are required in the 802.15.1 slaves.
Packet Traffic Arbitration (PTA)	Specifies a packet traffic arbitration unit in a device that contains both a 802.11 STA and an 802.15.1 node. Based on priorities when there is a potential TX scheduling overlap 802.11 or 802.15.1 packets are transmitted, under the control of the PTA unit
Deterministic interference suppression	Through a collocated 802.11 STA and 802.15.1 node, the 802.11 STA can know the frequency hopping sequence. The 802.11 STA receiver introduces a dynamic notch filter to suppress the interfering 802.15.1 transmission

# IEEE 802.15.2 Coexistence Mechanisms

Coexistence Mechanism	Description
Adaptive interference suppression	Unlike deterministic interference suppression, this approach does not require knowledge of the frequency hopping sequence. This technique estimates the narrowband interference and subtracts the interferer. This technique requires some delay to estimate and subtract the narrowband interferer
Adaptive Packet Selection	Intelligent scheduling of 802.15.1 SCO and ACL packet transmissions to optimize network throughput and as a result minimize channel occupancy, hence improving coexistence
Packet scheduling for ACL links	Scheduling of ACL packets to occur on channel frequencies which do not cause interference to 802.11 STA
Adaptive Frequency Hopping (AFH)	Modify the frequency hopping sequence by eliminating channels which cause interference to 802.11 STA

# IEEE 802.16h Coexistence Mechanisms

- The 802.16h base station collects information from the subscriber stations about interference
- Candidate Channel and Master Frame Assessment (CCMFA) is used to evaluate candidate channels, based on passive scanning, which is non-interfering
- A coexistence frame (CX-Frame) is introduced which is based on two time intervals
  - Coordinated Coexistence Schedule Based Interval (CXXBI)
  - Coordinated Coexistence Contention Based Interval (CXCBI)

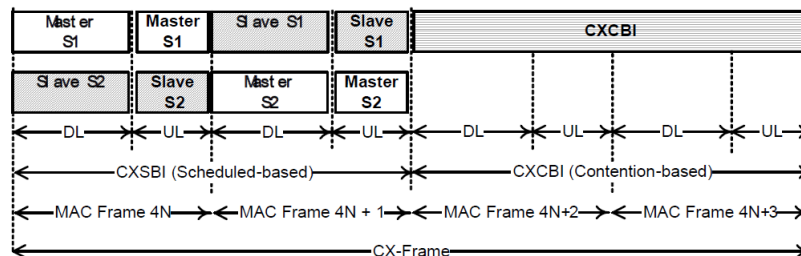

Figure 410—CX-Frame structure for CX-CBP

- For a simulation coexistence analysis see documents [5] and [6]

# IEEE 802.22 Self-Coexistence Mechanisms

## MAC self-coexistence schemes

## PHY coexistence mechanisms

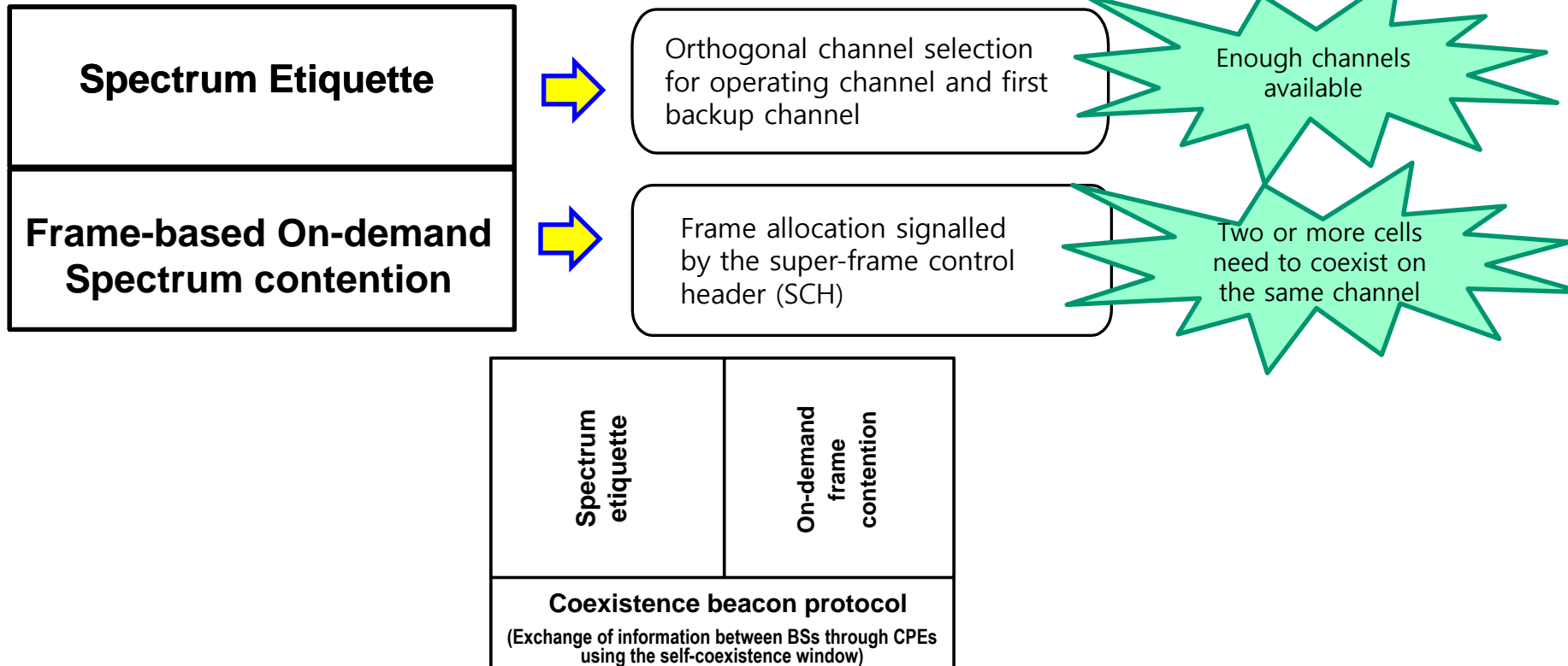

- Slides on 802.22 from [8]

# IEEE 802.22 Self-Coexistence Mechanisms

- **Spectrum Etiquette**

- Orthogonal channel assignment scheme between adjacent cells
  - different operating channel for overlapping or adjacent cells
  - different first backup channel

Requires that information on operating, backup and candidate channels of each cell is shared amongst WRAN cells: exchanged by CBP packets [5]

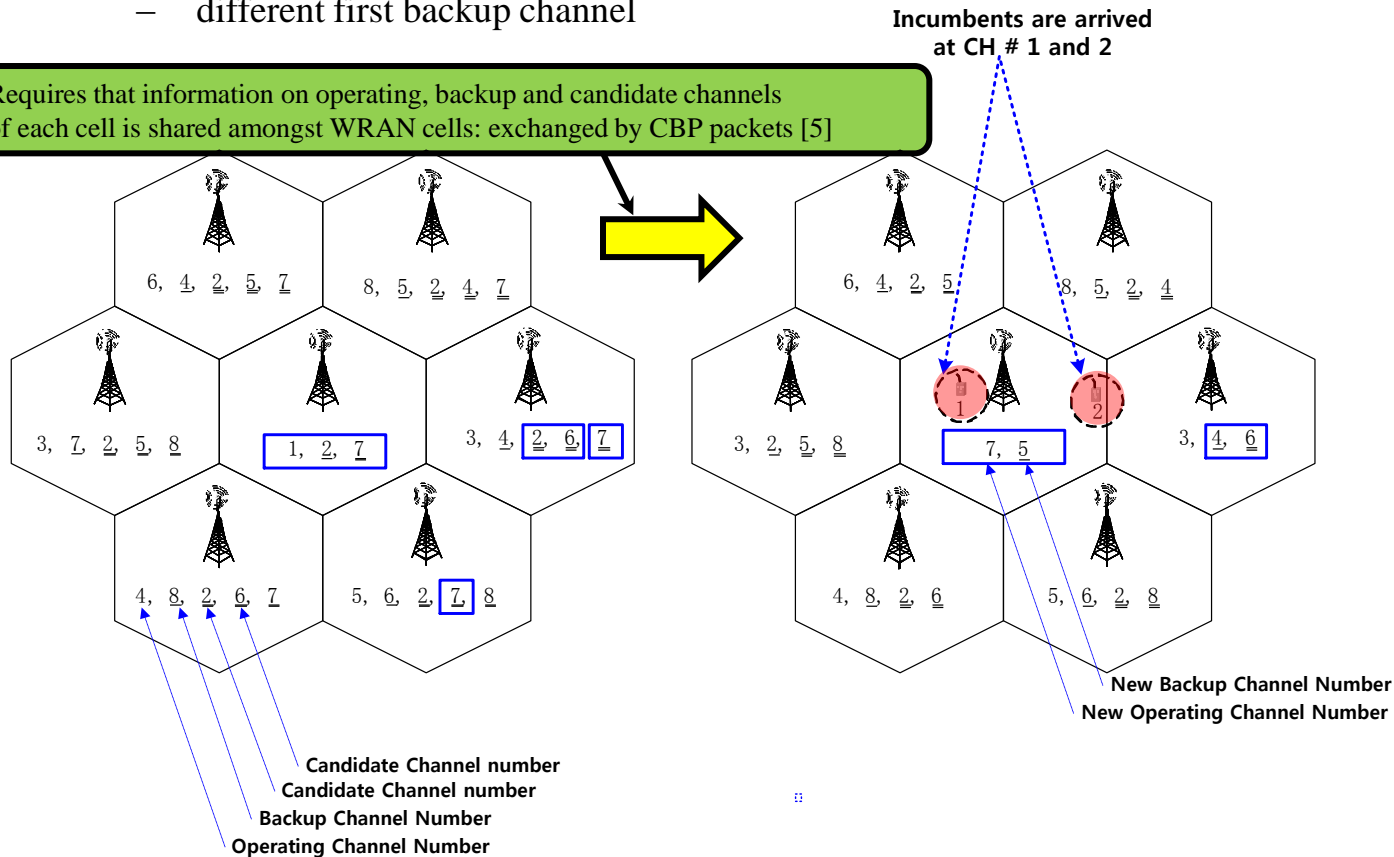

# IEEE 802.22 Self-Coexistence Mechanisms

- **On-demand Frame Contention**
  - Two or more cells need to co-exist on the same channel

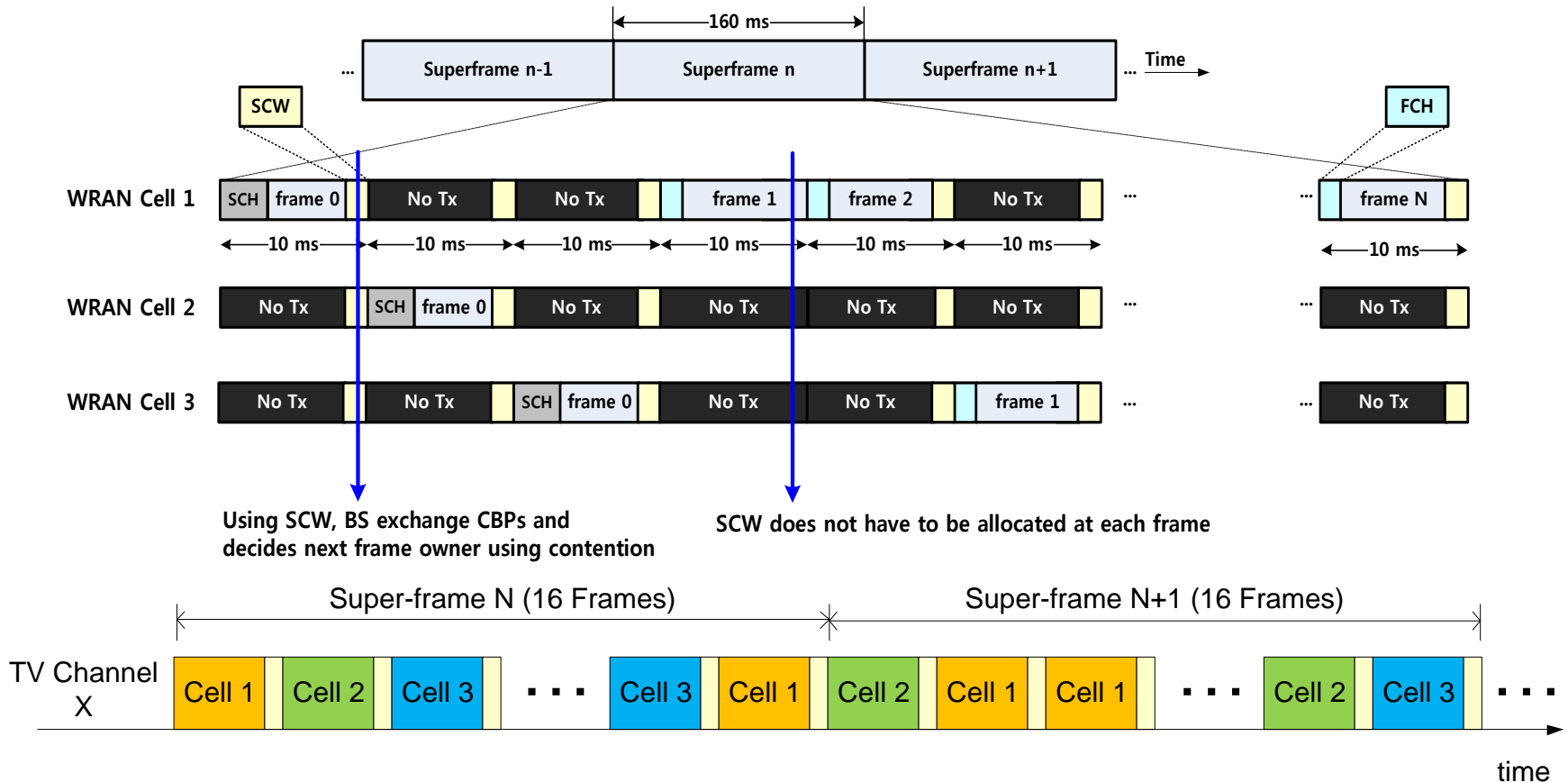



# Overview of IEEE 802.19.1

## Background

- **Radio regulations in some countries allow secondary radio systems to operate in TV white spaces**
- **White spaces are not exclusively assigned to a particular radio system, any system that fulfils the requirements of the radio regulation can operate**
- **Correspondingly, there is a need for coexistence mechanisms between different white space radio systems**
- **IEEE 802.19.1 [7] has addressed this need by developing standard for TV white space coexistence methods**

# Overview of IEEE 802.19.1

## System architecture

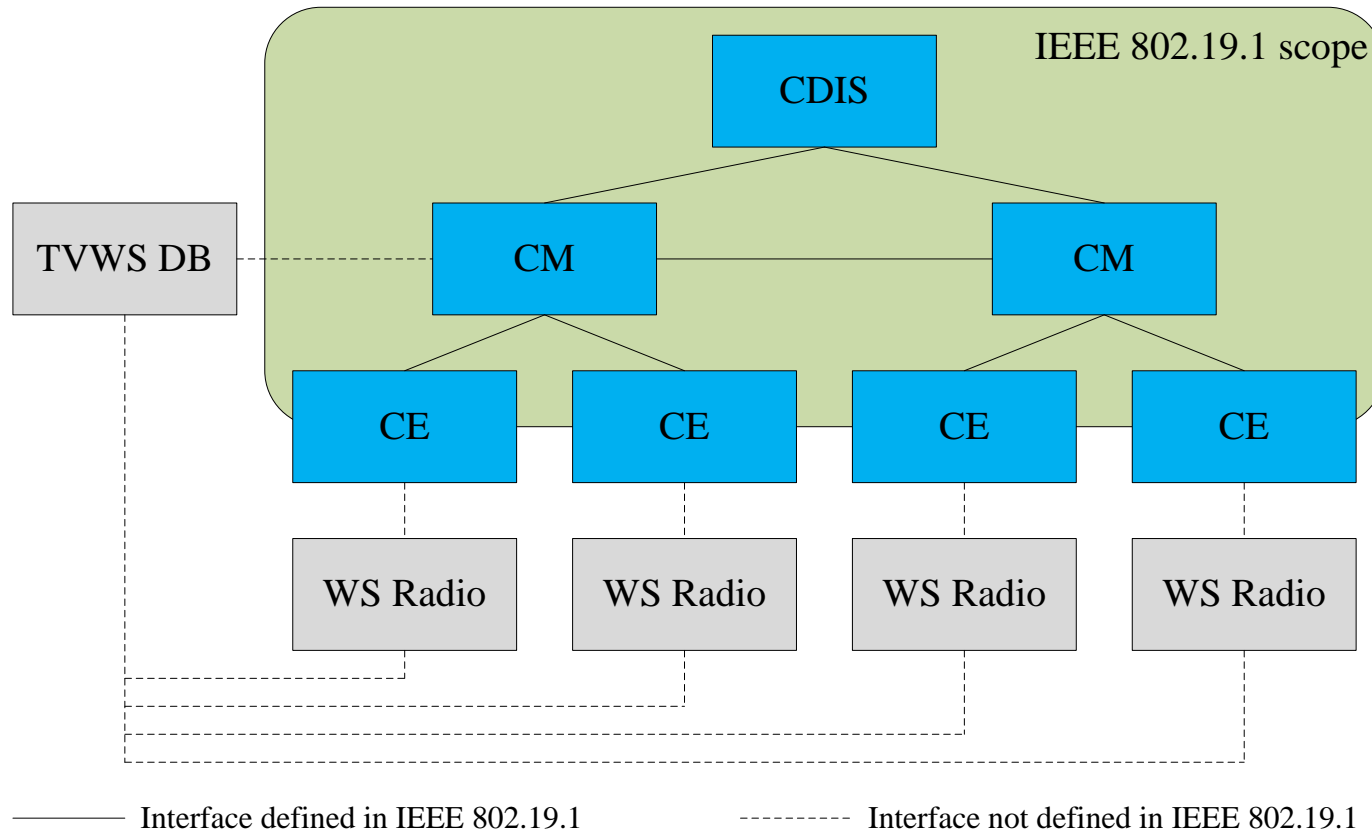

CDIS – Coexistence Discovery and Information Server    TVWS DB – TV whitespace database  
 CM – Coexistence Manager    WS Radio – whitespace radio  
 CE – Coexistence Enabler

# Overview of IEEE 802.19.1

## Coexistence discovery

- **Coexistence Discovery and Information Server (CDIS) supports discovery of the neighboring white space radio systems**
  - Two white space radio systems are neighbors if they are likely to cause one-way or mutual harmful interference to one another if they operate on the same frequency channel
- **Coexistence discovery information serves as an input to coexistence decisions making**

# Overview of IEEE 802.19.1

## Coexistence decision making

- **The IEEE standard 802.19.1 provides two ways to select parameters of a radio system**
  - Information service – coexistence system provides neighbor discovery information to a white space radio system and the white space radio system autonomously updates its operating parameters
  - Management service – coexistence system manages the operating parameters of a white space radio system using Coexistence Manager (CM)
- **These services are provided by the IEEE 802.19.1 coexistence system to subscribed white space radio systems**

# Overview of IEEE 802.19.1

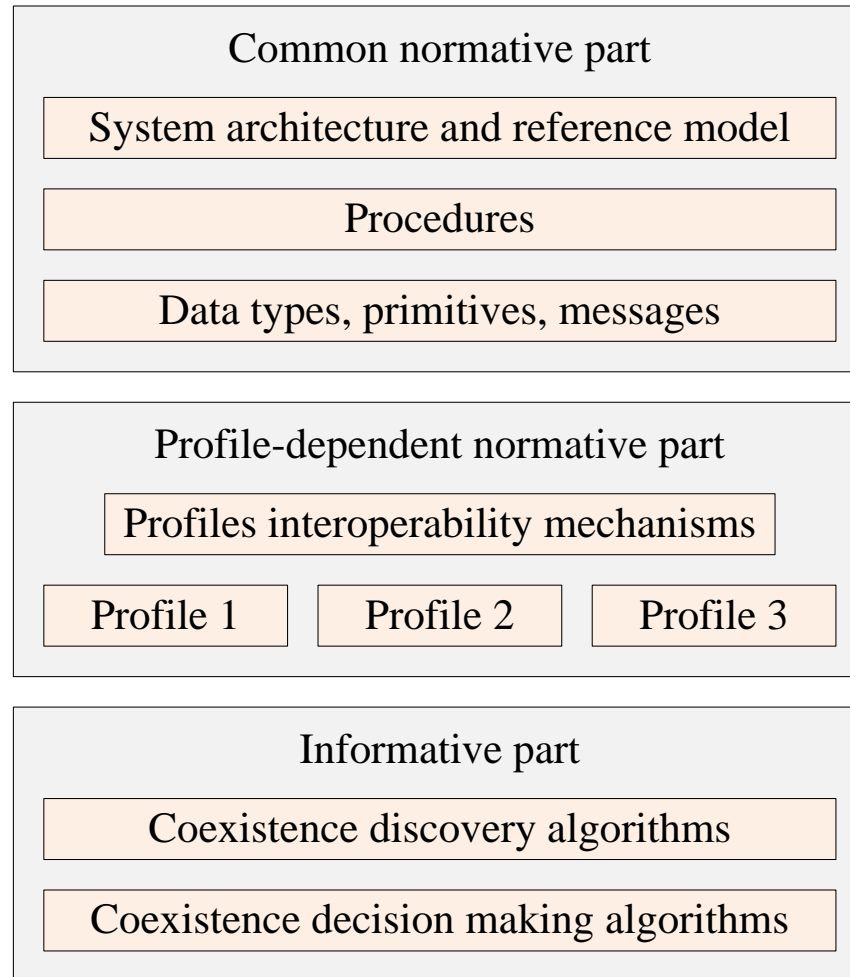

# Overview of IEEE 802.19.1

## Performance improvement

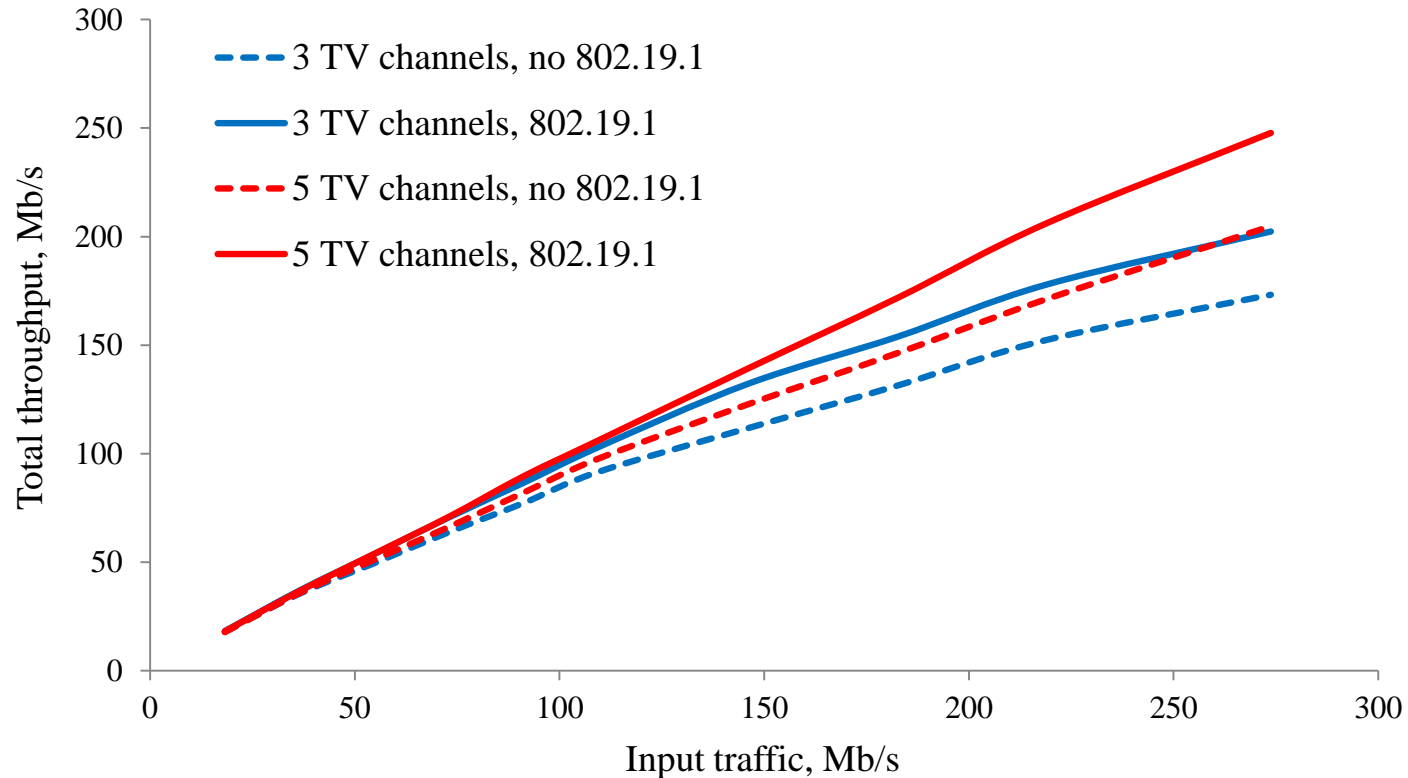

- **Gain in throughput is 17% for 3 TV channels**
- **Gain in throughput is 21% for 5 TV channels**

# Overview of IEEE 802.19.1

## Summary

- **IEEE 802.19.1 is standard that defines coexistence system for radio systems operating in TV whitespace**
- **IEEE 802.19.1 coexistence system can provide different level of services to the users based on their subscription**
- **Different profiles are defined to support various deployment scenarios and use cases**
- **Simulation shows performance improvement from using IEEE 802.19.1 coexistence system**
- **Implementation of the IEEE 802.19.1 coexistence system was done for feasibility study of the developed protocol (see IEEE 802.19-12/138r0 for more details)**

# IEEE 802 Coexistence Process (1 of 2)

- **The IEEE 802 Operations Manual includes a procedure on Coexistence Assurance**
  - [http://www.ieee802.org/PNP/approved/IEEE\\_802\\_OM\\_v15.pdf](http://www.ieee802.org/PNP/approved/IEEE_802_OM_v15.pdf)

## 13. Procedure for coexistence assurance

- *If indicated in the five criteria, the wireless WG shall produce a coexistence assurance (CA) document in the process of preparing for WG letter ballot and Sponsor ballot. The CA document shall accompany the draft on all wireless WG letter ballots.*
- *The CA document shall address coexistence with all relevant approved IEEE 802 LMSC wireless standards specifying devices for unlicensed operation. The WG should consider other specifications in their identified target band(s) in the CA document.*



## IEEE 802 Coexistence Process (2 of 2)

### 13. Procedure for coexistence assurance (cont.)

- *The IEEE 802.19 WG shall have one vote in WG letter ballots that include CA documents. As part of its ballot comments, the IEEE 802.19 WG will verify the CA methodology was applied appropriately and reported correctly.*
- *The ballot group makes the determination on whether the coexistence necessary for the standard or amendment has been met.*
- *A representative of the IEEE 802.19 WG should vote in all wireless Sponsor ballots that are in the scope of the IEEE 802.19 coexistence WG.*

# References

1. **IEEE Std 802.11-2012, “Wireless LAN Medium Access Control (MAC) and Physical Layer (PHY) Specifications,” March 29, 2012**
2. **IEEE Std 802.15.2-2003, “Coexistence of Wireless Personal Area Networks with Other Wireless Devices Operating in Unlicensed Frequency Bands,” August 28, 2003**
3. **Nada Golmie, “Coexistence in Wireless Networks: Challenges and System-Level Solutions in the Unlicensed Bands,” Cambridge University Press, 2006**
4. **IEEE Std 802.16h, “Air Interface for Broadband Wireless Access: Amendment 2 Improved Coexistence Mechanisms for License-Exempt Operation,” July 30, 2010**
5. **Shahar Huzner and Mariana Goldhamer, “Coexistence Assurance Document for 802.16h CX-CBP,” IEEE 802.19-09/7r0, March 9, 2009**
6. **John Sydor, “Messaging and Spectrum Sharing between ad-hoc Cognitive Radio Networks,” IEEE Symposium on Circuits and Systems, 2006**
7. **IEEE Std 802.19.1-2014, “TV White Space Coexistence Methods,” May 16, 2014**
8. **Apurva Mody, et. al., “Introduction to IEEE Std. 802.22-2011 and its Amendment PAR for P802.22b: Broadband Extension and Monitoring,” IEEE 802.22-11/132r3, November 2011**