

Project: IEEE P802.15 Working Group for Wireless Personal Area Networks (WPANs)

Submission Title: [HIPERPAN: a COFDM Scheme for IEEE's High Rate WPAN]

Date Submitted: [September 2000]

Source: [Marc de Courville & Veronique Buzenac] [David Skellern, John O'Sullivan & Andrew Myles]
Company: [Motorola] [Radiata Communications]

Address: [Espace technologique Saint Aubin] [1 Julius Ave, North Ryde,]

[Gif sur Yvette, 91193, France]

[Sydney NSW 2113 Australia]
[+61 2 8874 5404/+61 2 8874 5401],

email: [courvill@crm.mot.com] [daves@ieee.org]

Re: [TG3 PHY layer submission]

Abstract: [This contribution is a proposal for a high rate WPAN (up to 43 Mbit/s) operating in the 5GHz U-NII bands. The system uses Coded Orthogonal Frequency Division Multiplex modulation and is similar to the 802.11a / HIPERLAN/2 standards with some major simplifications that allow a lower complexity, low cost receiver. Note that this proposal is a merging of Motorola and Radiata former contributions.]

Purpose: [Response to WPAN-TG3 Call for Proposals]

Notice: This document has been prepared to assist the IEEE P802.15. It is offered as a basis for discussion and is not binding on the contributing individual(s) or organization(s). The material in this document is subject to change in form and content after further study. The contributor(s) reserve(s) the right to add, amend or withdraw material contained herein.

Release: The contributor acknowledges and accepts that this contribution becomes the property of IEEE and may be made publicly available by P802.15.

HiPerPAN: a COFDM Scheme for IEEE's High Rate WPAN *A globally harmonized revised proposal*

September 2000



MOTOROLA



Motivation for this merged proposal:

- ① **from coexistence to compatibility:** grant interoperability with 5GHz worldwide harmonized WLAN standards: IEEE802.11a, ETSI BRAN HIPERLAN/2, ARIB MMAC HiSWAN by providing a *common signal format for resource allocation*
- ② **personal means worldwide operation:** provide access to 5GHz band as spectrum opportunity for WPAN: regulatory issue for accessing this license exempt band in Europe, grants 12 channels of 20MHz in the US, 19 channels in Europe, 4 channels in Japan; elsewhere?

Proposal overview

- **5GHz OFDM proposal merging:** this PHY proposal is the result from the merging of the two 5GHz OFDM former proposals (Radiata and Motorola HIPERPAN)
- **MAC pairing:** this PHY proposal is to be paired with the Motorola (Walt Davis)/ShareWave joined enhanced MAC proposal
- Two operating modes are provided:
 - **coexistence:** requires Dynamic Frequency Selection (DFS) not to disturb WLANs and mandatory for operating in Europe (CEPT). Three different PHY modes defined for payload. Transmit Power Control (TPC) is not required.
 - **compatibility:** requires additional signalling and the associated PHY mode (BPSK + rate 1/2 bit interleaved convolutional code). QPSK 1/2 is also used for payload compatibility.
- Hooks for compatibility with IEEE802.11a and HIPERLAN/2 are provided at the PHY level, but *will require* MAC enhancements

Worldwide operation at 5 GHz is achieved through harmonization of signalling fields and frame formats

Illustration of the different operation modes

***Adhoc network: WPAN
only or 802.11a***

***Compatibility mode
with HIPERLAN/2***

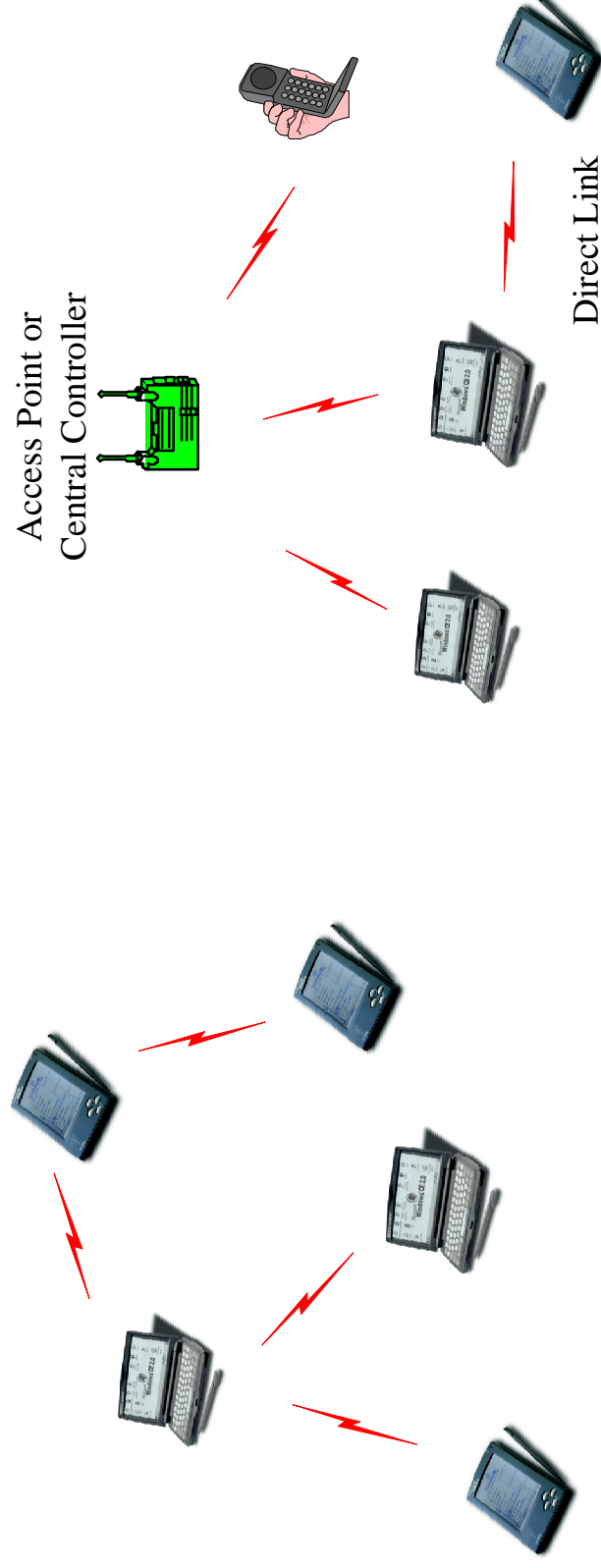

- Implementation of IEEE802.11a and HIPERLAN/2 signaling fields provide a way to embed WPAN transmissions in the 5GHz OFDM WLANs frame structure
 - through PLCP frame format of IEEE802.11a
 - through Direct Link resource allocation requests in HIPERLAN/2
- The WPAN payload is conveyed using dedicated WPAN constellations

PMD - Channels

- In US: Use same channels as IEEE 802.11a: 12 channels in the US non-contiguous 5 GHz Unlicensed National Information Infrastructure bands

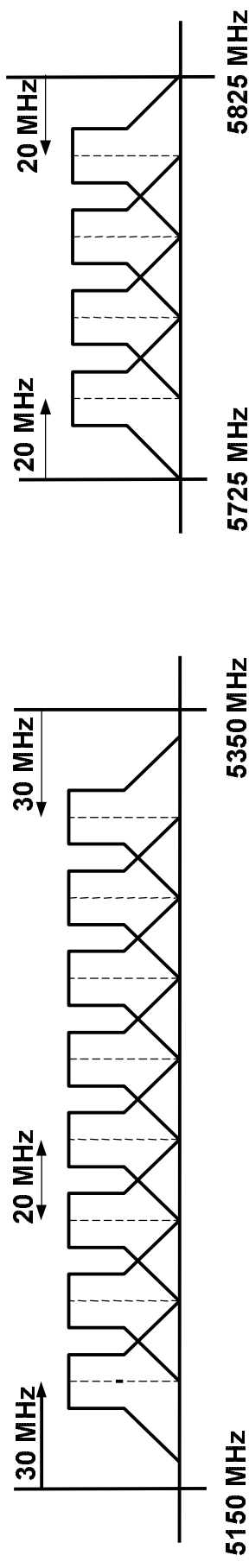

- In Europe: Use same channels as HIPERLAN/2: 19 channels in the non-contiguous 5 GHz license-exempt bands

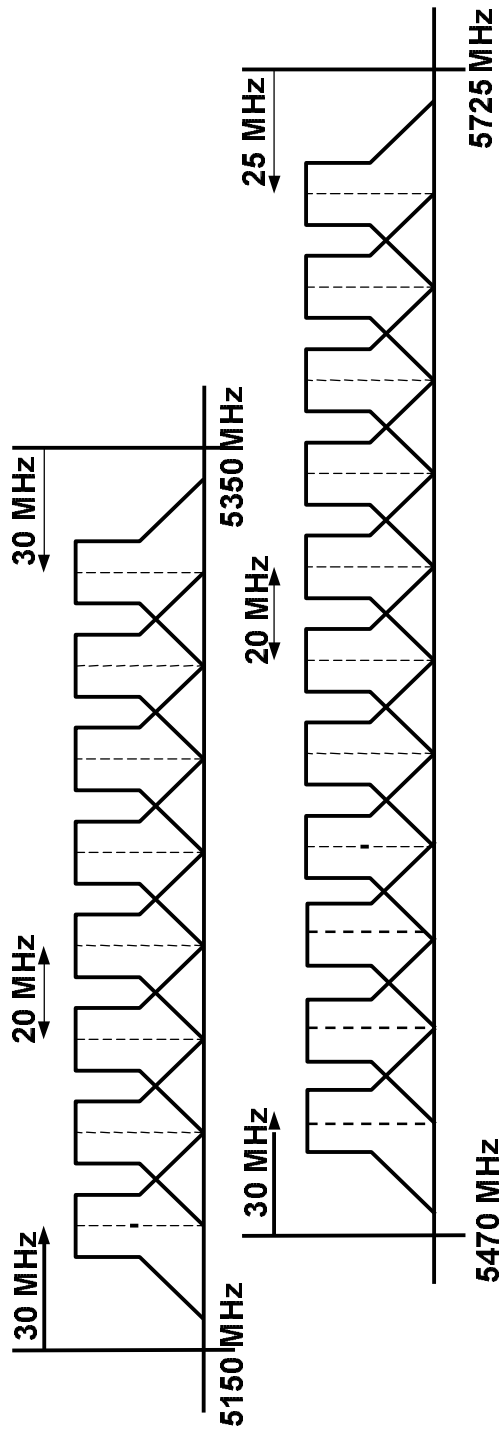

Spectrum regulation status: where to operate worldwide

Band	range GHz	USA	Europe
I	5.15-5.35	unlicensed	license exempt
II	5.47-5.725	unavailable	license exempt
III	5.725-5.825	unlicensed	unlicensed

Bands I and II are reserved to HIPERLANs in Europe (DFS&TPC mandatory, modulations: GMSK and OFDM)

Remarks:

- 1) HiPerPAN is able to operate full rate (43Mbps) in the US in the bands I and II
- 2) HiPerPAN is able to operate full rate (43Mbps) in EU in band III (25mW restricted)
- 3) for the moment HiPerPAN is able to operate at reduced rate (12Mbps) in EU in bands I and II. The goal (and this is under discussion at the ETSI), is to have WPAN included in the BRAN standard that would allow the full rate operation in these two bands as well.

PMD - OFDM Parameters

Propose use of a coexistence/compatibility COFDM system with 52 carriers in a 20 MHz channel with 400ns guard time for multipath signals.

<i>Parameter</i>	<i>Value</i>	<i>Signalling fields (compatibility)</i>	<i>Direct Link (payload)</i>
Sampling rate $f_s=1/T$	20 MHz		
Useful symbol part duration	64*T 3.2 us		
Cyclic prefix duration	16*T 0.8us	8*T 0.4us	
Symbol interval	80*T 4.0us	72*T 3.6us	
Number of data sub-carriers	48		52
Number of pilot sub-carriers	4		0
Total number of sub-carriers	52		52
Sub-carrier spacing	0.3125 MHz		
Spacing between the two outmost sub-carriers	16.25 MHz		

OFDM PHY overview

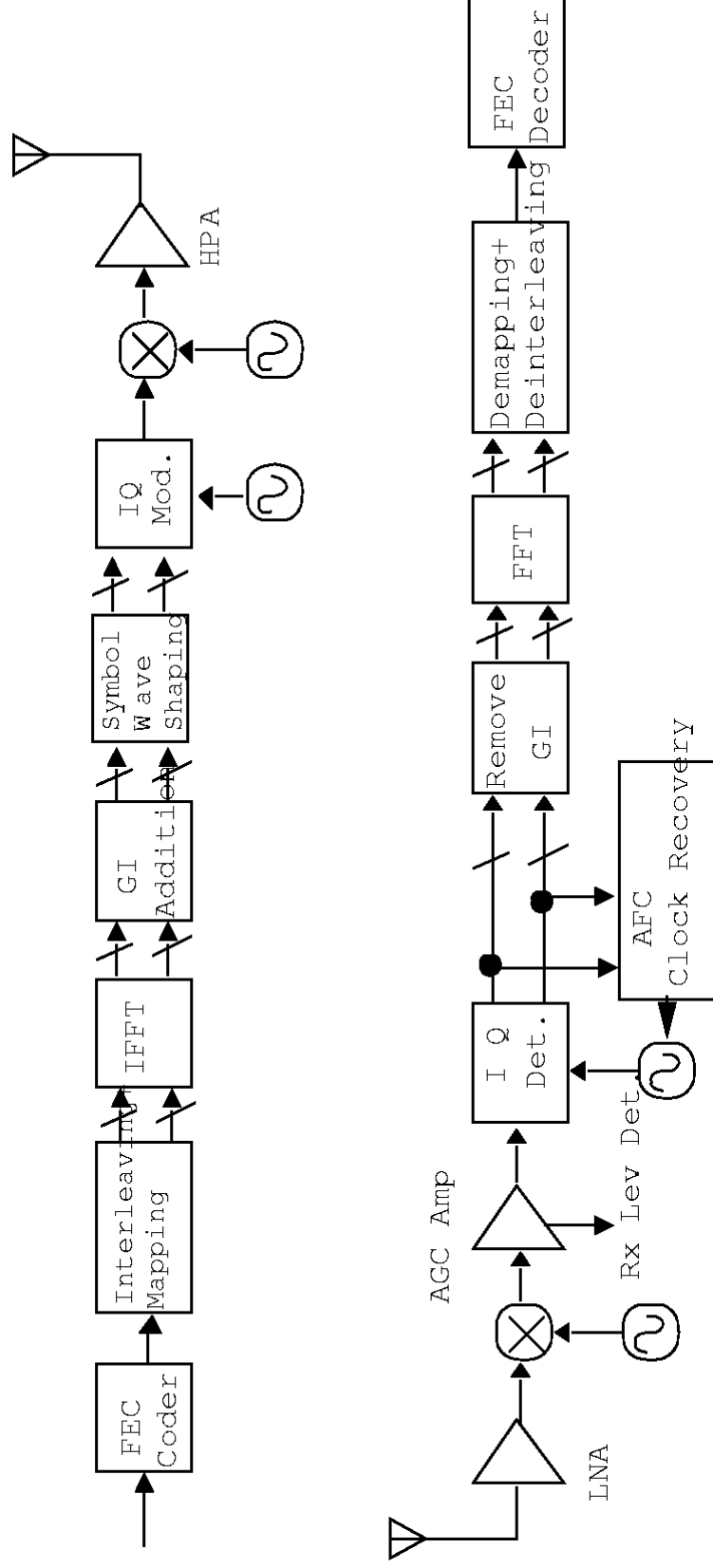

PLCP - Preamble & sync

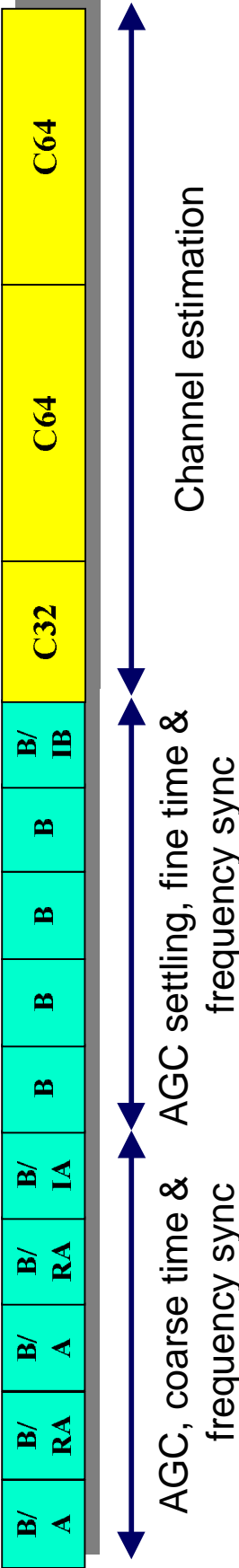
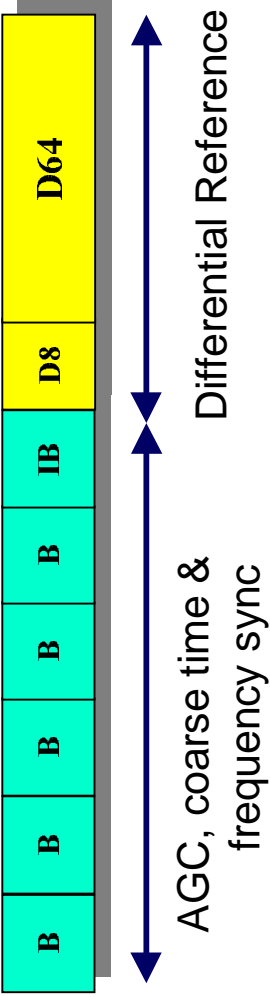
- Include support for 2 preambles formats:
 - IEEE802.11a / HIPERLAN/2 for compatibility
 - WPAN only: 802.15.3
- **Compatibility: 802.11a PLCP / HiPERLAN/2 BCH preamble (16 μ s)**

- **WPAN only: 802.15.3 preamble proposal (8.4 μ s)**

Note that differential modulation greatly simplifies synchronization, avoids equalization and reduces preamble length

PMD - PHY Rates

The proposal provides 6, 12, 14, 21, 29 & 43 Mbit/s using bit interleaved convolutional coded BPSK, QPSK, DQPSK and D8PSK, symbol interleaved trellis coded D8PSK and uncoded D8PSK modulations. Data is scrambled and a length 52 or 48 interleaving is used.

The BPSK and QPSK modes provide compatibility with standardized 5 GHz OFDM systems.

Data Rate Mbit/s	Modulation/ Code	Coding rate	coded bits per subcarrier	Eb/N0 BER 10 ⁻⁵	C/N BER 10 ⁻⁵	Range m (Free Space)	Range m (ITU 0 Floor)	Range m (ITU 1 Floor) ¹	Number of pilots
6,0	BPSK (2,1,7)	1/2	1	6	3,0	265	37	11	4
12,0	QPSK (2,1,7)	1/2	2	6	6,0	188	29	9	4
14,4	DQPSK (2,1,7)	1/2	2	7,3	7,3	162	27	8	0
21,7	D8PSK(2,1,7)	1/2	3	10,7	12,5	89	18	6	0
28,9	D8PSK trellis (4s)	2/3	3	12,5	15,5	63	14	4	0
43,3	D8PSK uncoded	1	3	17,3	22,1	29	9	3	0

- AWGN channel, range for 1mW Tx power, 0 dBi Tx antenna gain, 0 dBi Rx antenna gain, 7 dB Rx NF and path loss based on ITU P.1238

1 floor attenuation = 16dB

BER Performance (504 bytes packets, 5000 packets TX)

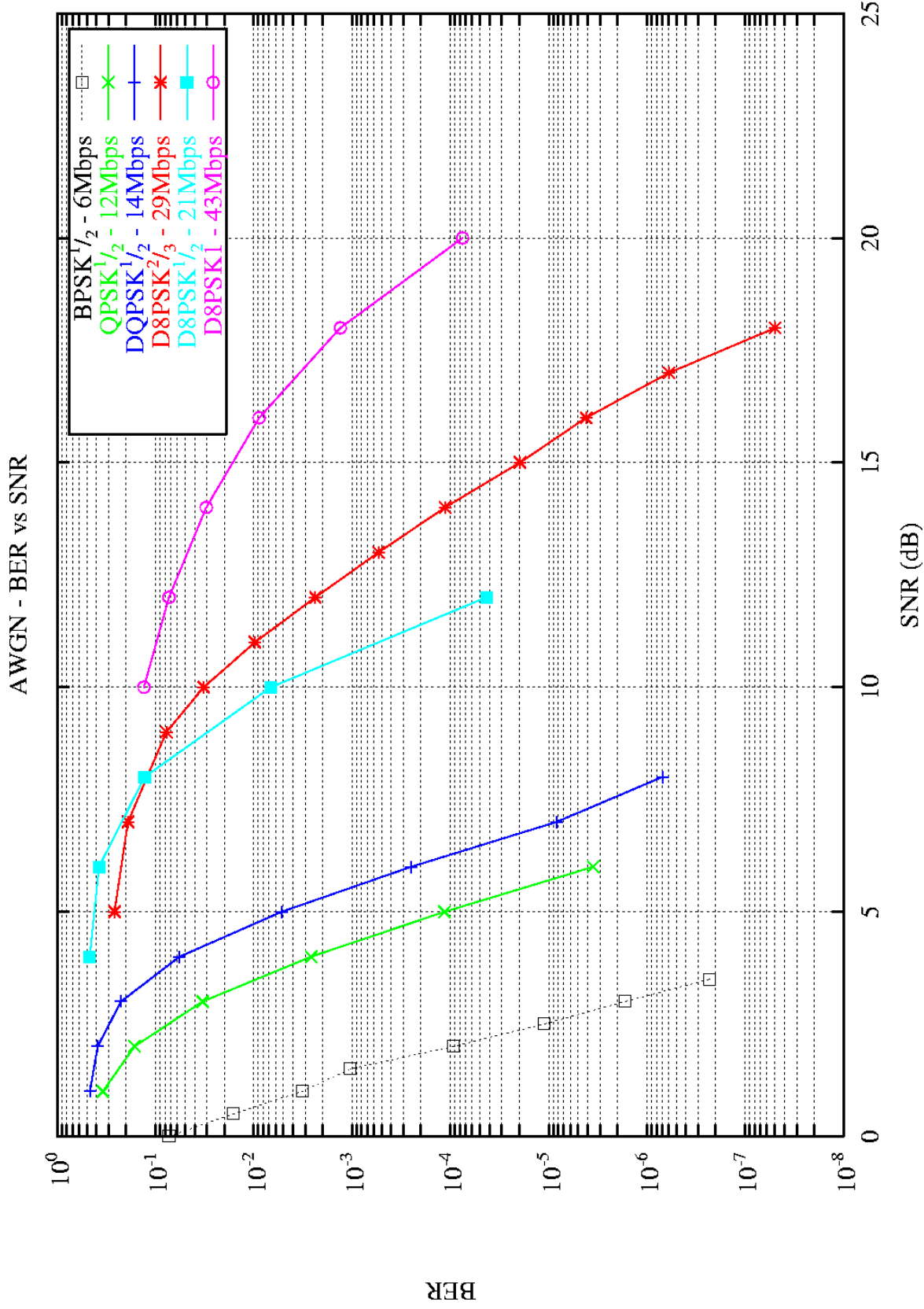

Features/Interoperability

Areas of flexibility for the WPAN solution implementation

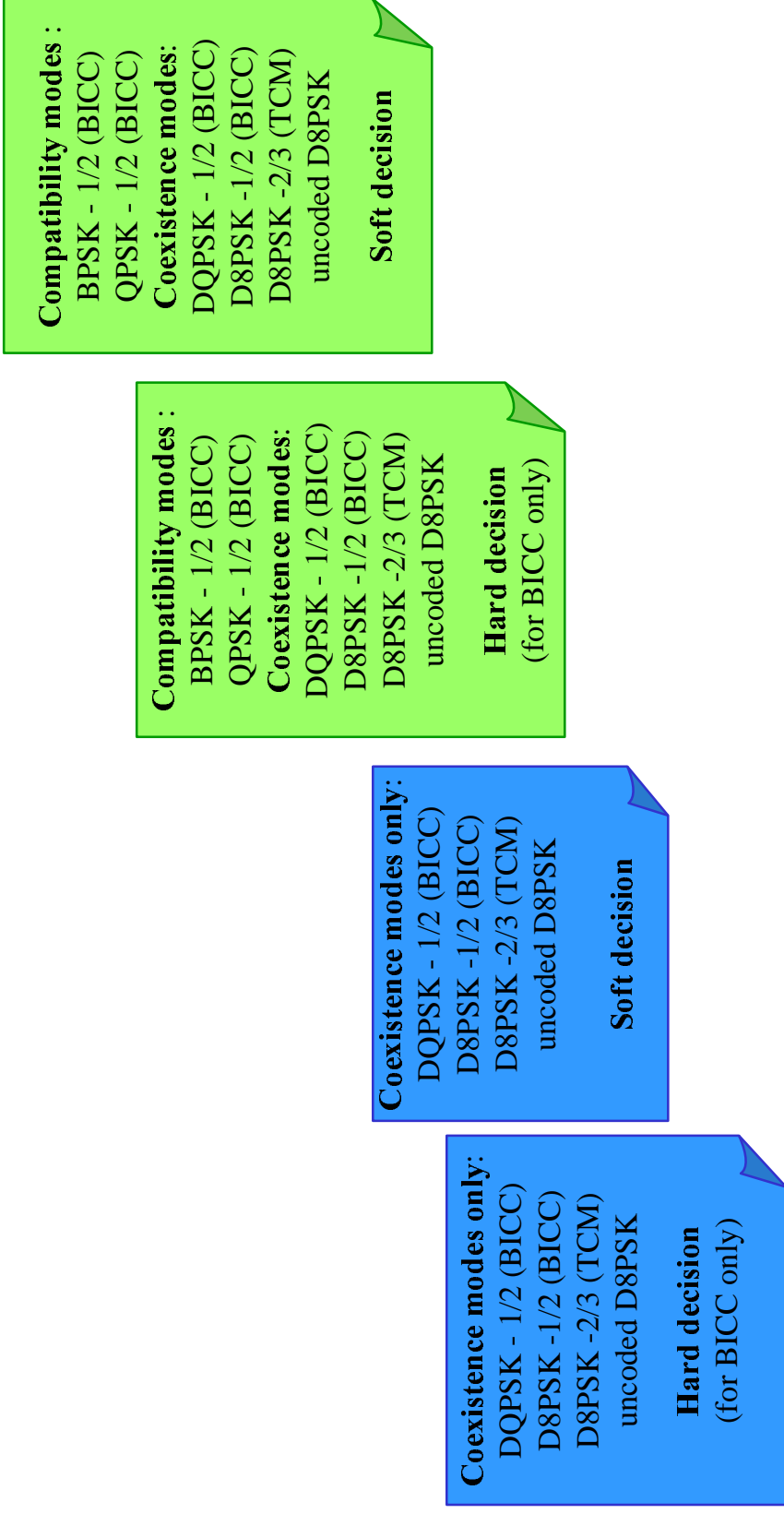

Important notice: the overhead of silicium required for compatibility is only used 10% of the time for preamble decoding resulting in large power consumption savings

General solution criteria

4 September 2000

2.1 Unit Manufacturing Cost

Suggest node structure as shown below - an elaboration of Figure 1 of the TG3 Criteria Definitions document

Focus of manufacturing cost challenge

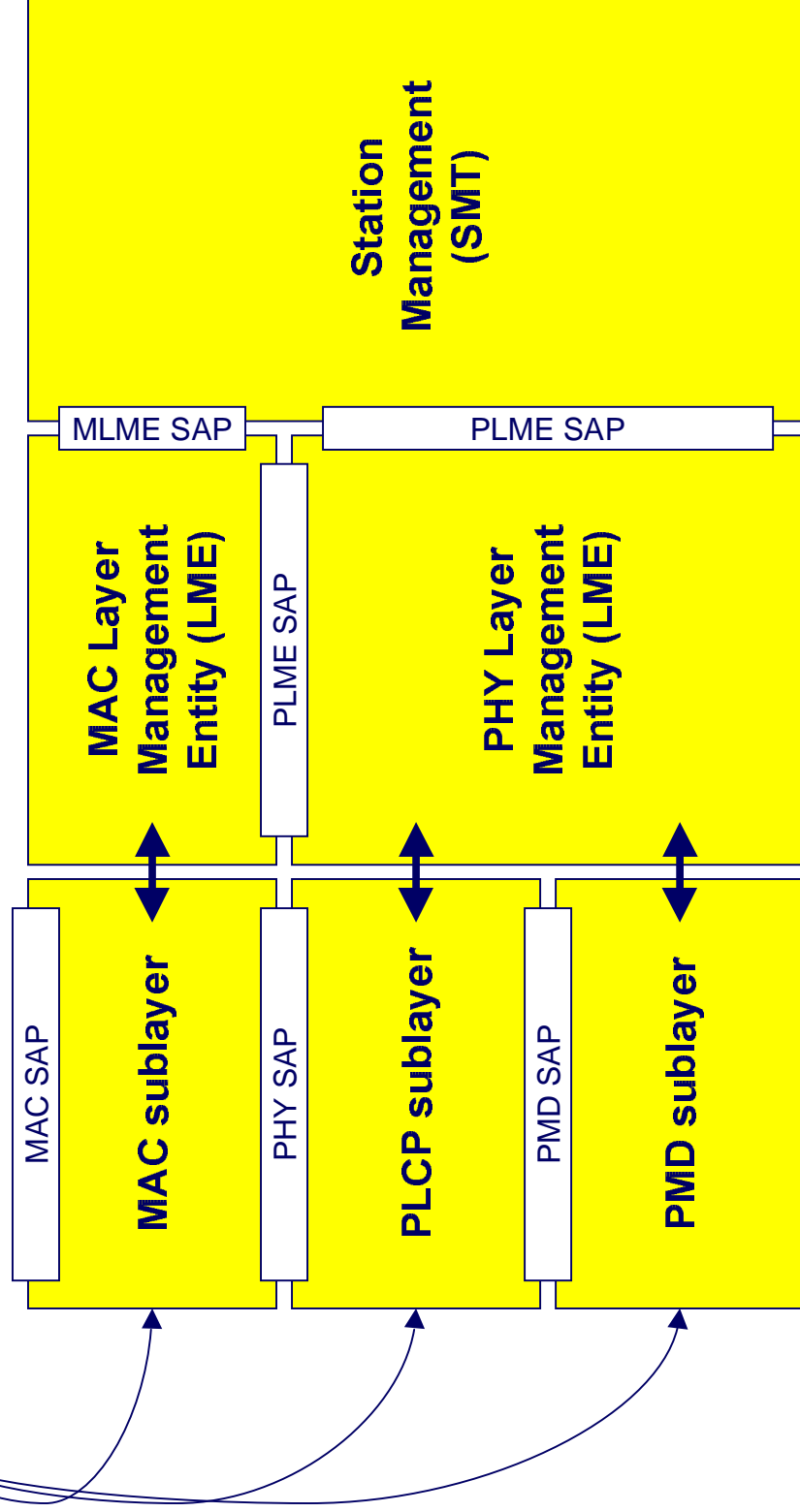

2.1 Unit Manufacturing Cost

A NIC consists of a three main functional components with minimal passive and no extra active components

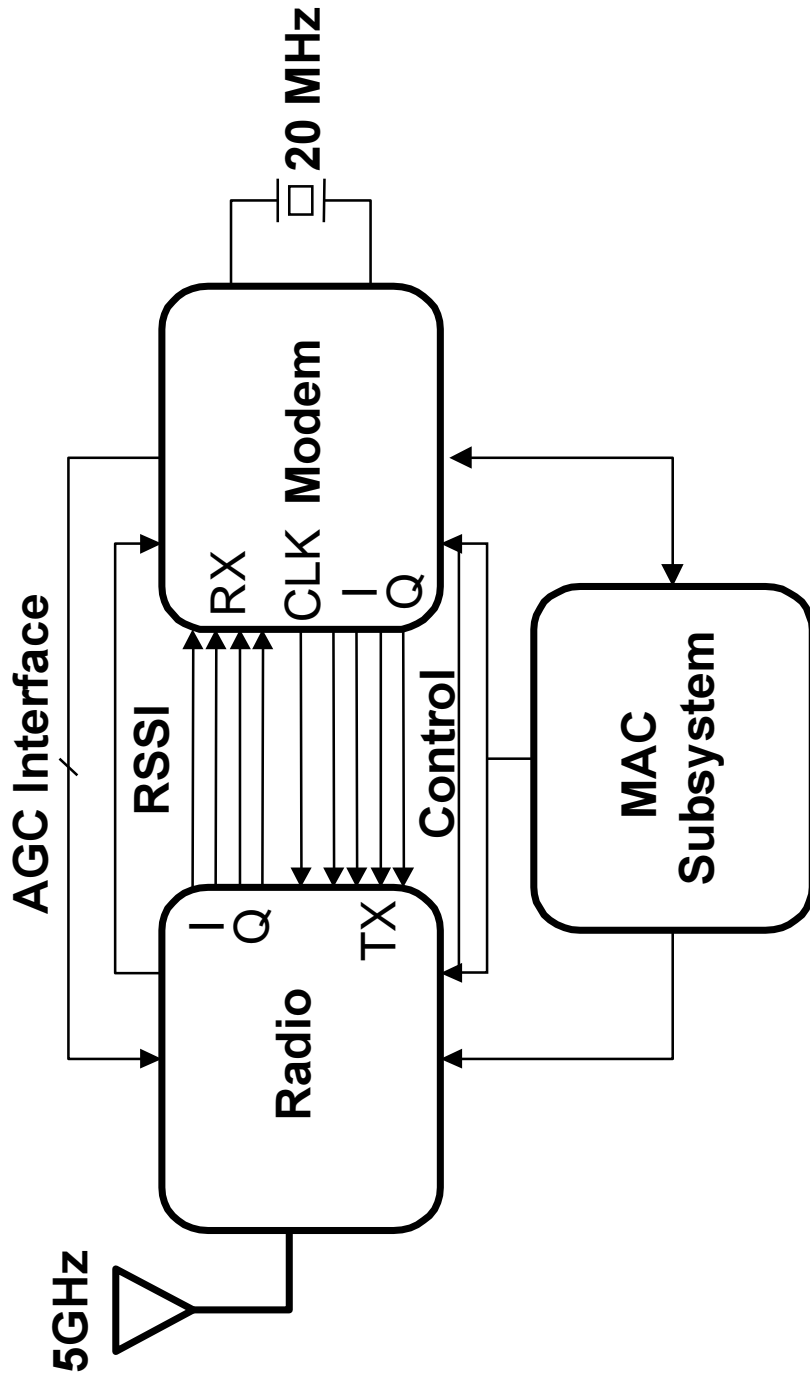

2.1 Unit Manufacturing Cost

All active components can be implemented in CMOS - initially a modem/MAC chip and an RF chip, and eventually a single chip

- The modem is order 130k gates (scaling from our implementations 802.11a and HIPERLAN/2 systems):
 - compatibility WPAN with 5GHz OFDM WLANs: around 130k gates
 - WPAN operation only: around 90k gates
- ⇒ Digital baseband is 2-3 times smaller than 802.11a
- Add Dual (I/Q) 8-bit ADCs and DACs
- An appropriate 802.11-like MAC is order 60k gates plus memory
- A 0dBm, 7dB NF 5 GHz dual conversion transceiver including VCOs and filters is now possible in 0.18um CMOS in a chip area of less than 20mm² with good yield
- CMOS cost curves will guarantee the continued price reductions needed to achieve target consumer cost levels
- ⇒ Cost projection for IEEE802.11a / HIPERLAN/2 2001 <60\$ going down to 40\$ in 2003.
- ⇒ Cost factor reduction of a factor of 2 expected for HIPERLAN leading to 20-30\$ products. Single chip solution (low TX power) and simplified baseband.

2.2 Signal Robustness

• 2.2.2. Interference and Susceptibility

- COFDM is relatively tolerant of interference. Cochannel interference is determined by the C/N of the modulation employed on each carrier. Adjacent channel is largely determined by specifics of the implementation. BT specs is almost equivalent to IEEE802.11a. Meeting these will grant the same interference and susceptibility. However, better can be achieved with highest quality RF-FE (cost/perf trade-off)

• 2.2.3. Intermodulation Resistance

- Intermodulation is largely determined by the particular receiver implementation dynamic range.
- Subcarrier intermodulation requires operation in a relatively linear region.
- Coded D8PSK requires backoff of ~5dB from 1dB compression point for non-linearised PA or ~3dB for a linearised PA

• 2.2.4. Jamming Resistance

- 802.11a cannot be considered as a jammer since compatibility is achieved (BPSK). Moreover >12 channels of 20MHz exist granting possibility of frequency isolation between 802.11a/b and HIPERPAN. 802.15.1 cannot interfere since it is in the 2.4GHz band. 5GHz is immune to microwave spurious

• 2.2.5. Multiple Access

- The existence of multiple channels allows multiple systems to coexist without interference, one of each channel. The system filtering, proposed to be the same as 802.11a, ensures low non-interfering out-of-channel emissions

• 2.2.6. Coexistence

- The only potentially interfering system is 802.11a - use of an 802.11-style MAC will ensure coexistence

2.3 Interoperability

The proposed system is interoperable with 802.15.1 only by addition of an 802.15.1 stack and bridging function

- The frequency band is 5 GHz of Bluetooth at 2.4 GHz
 - A separate radio is needed
- The Bluetooth MAC differs greatly from the proposed MAC
 - A separate 802.15.1 MAC implementation is needed
- If we add an 802.15.1 stack, a bridging function is needed between the it and the 802.15.3 stack.

2.4 Technical Feasibility

Eminently feasible

- **2.4.1. Manufactureability**
 - The picture displayed next slide shows a complete PHY for the IEEE 802.11a WLAN standard including a single chip modem and single chip 5 GHz radio plus an LNA, PA, tx/rx switch and diversity switch. The LNA, PA, tx/rx switch and diversity switch are not needed for a WPAN, which requires only passive components and an oscillator plus the modem and radio chips. This implementation is in a PCMCIA Type II format and uses one board side only of a six layer board. The layout is -very- sparse and could be shrunk to compact flash size. This implementation demonstrates the manufacturability of the technology.
- **2.4.2. Time to Market**
 - Modem and MAC chips of greater complexity have been demonstrated
 - Prototype 5 GHz RF CMOS transceivers have been demonstrated and production versions are in development with demonstrations expected before the end of 2000
- **2.4.3. Regulatory Impact**
 - TRUE (U-NII rules)
- **2.4.4. Maturity of Solution**
 - COFDM systems of this type have been built and run by several groups and companies around the world.
 - COFDM systems already are available on the market place and operating: ADSL (6Mbps), Digital Audio Broadcasting (1.5Mbps), Digital Video Broadcasting (36Mbps)

2.4.4 Technical Feasibility - Maturity of Solution

Complete COFDM (802.11a) PHY layer on one side of a PCMCIA card - sparse layout includes many circuits not needed for WPAN (including LNA, PA, Tx/Rx and diversity switches) - can compress to CF format single side leaving reverse side for MAC.

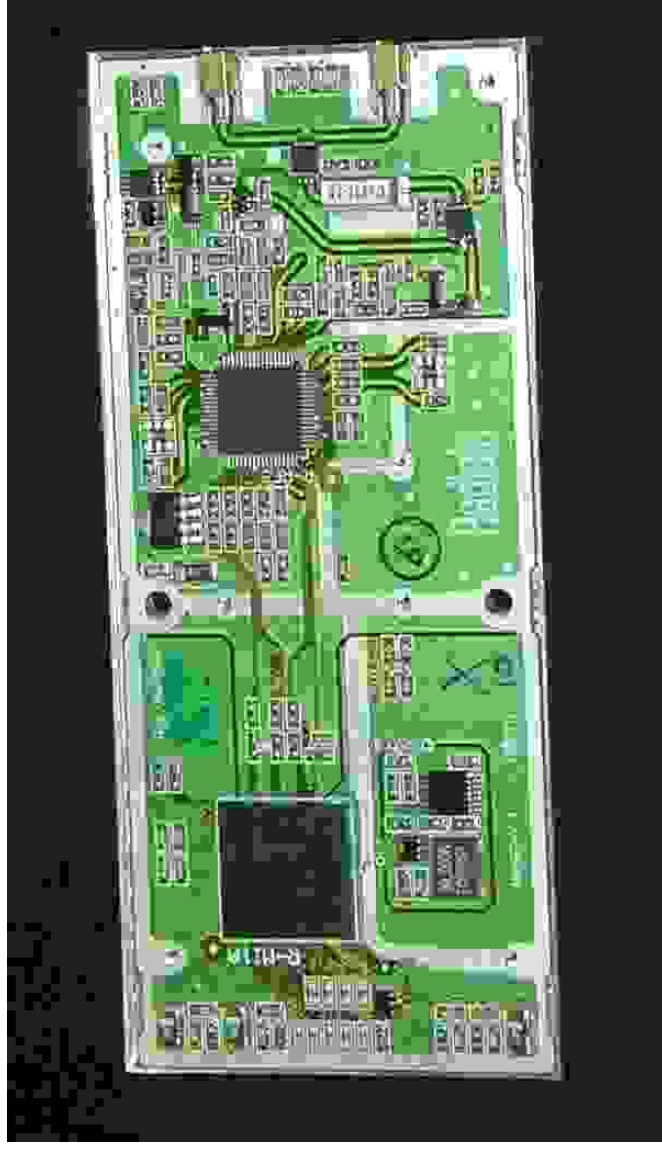

2.5 Scalability

While COFDM is very scalable, the parameters and functionality for this proposal are optimised for the cost/data rate/complexity/power tradeoff given the relatively less demanding PAN compared to a LAN.

- **Power consumption**
 - Can be controlled by variable transmit power
- **Data Rate**
 - Data rate in this proposal can be scaled by increasing the clock rate and, consequently, bandwidth and power consumption (there is effectively an upper limit on bits/Hz for a low complexity, low power design)
- **Frequency Band of Operation**
 - Operation in any frequency band is possible - 5 GHz is attractive because of the low level of interfering signals
- **Cost**
 - The proposal is optimized for cost - reductions will be incremental and process and volume driven
- **Function**
 - The proposal functionality is optimised for cost. Skipping compatibility modes will decrease the overall system cost.

802.15.3 PHY Criteria Notes

4 September 2000

4.1 Size and Form Factor - New criteria

- (1) Radio functionality/size:
 - **Q:** How backward compatibility with 802.15.1 spec is achieved, (RF blocks repeated, shared, etc.?)
 - **A:** This proposal requires a quadrature radio transceiver with a front-end in the 5 GHz band. With a new 2.4GHz front-end and down converter the remainder of the radio could be used and the 802.15.1 signal decoded at baseband. Dual front-end system will be the way of the future for many multi-standard radios.
 - **Q:** Transmit power, power amplifier back-off, and efficiency at the transmit power
 - **A:** Tx power is 0 dBm. For a non-linearised power amplifier, the required backoff is 4-5 dB from the 1 dB compression point of the output PA. This can be improved significantly with even modest linearisation of the output PA. Improvements of around 3dB might be expected (ie to 2dB backoff) for a linearised PA. The efficiency depends heavily on the implementation. The worst case is a Class A output stage, which for 5 dB backoff would achieve around 8% efficiency.
 - **Q:** Chip area, process technology
 - **A:** The chip area for the transceiver, including on-chip analog filters, is estimated to be less than 18 mm^2 in 0.18 μ CMOS technology. This area estimate is obtained by scaling of an existing implementation of a single chip 5 GHz CMOS transceiver for the 802.11a WLAN standard. It is anticipated that this area will be reduced as the design is refined.

4.1 Size and Form Factor - New criteria (cont.)

- (2) Baseband functionality/size (PHY baseband only):
 - Q: A/D and D/A converter precision, speed
 - A: 8-bit A/D and D/A provide ample quantization noise as well as head room for AGC acquisition. 40 Msample/s quadrature units (baseband I/Q converters) give more than 2x oversampling and result in quite relaxed tx/rx filter specifications
 - Q: Digital filter lengths for pulse shaping
 - A: raised cosine OFDM symbol shaping requires simple shift and add operations over three samples only
 - Q: Equalizer length (i.e., number of coefficients)
 - A: Not applicable for OFDM
 - Q: Decoder complexity (e.g. type of decoder like convolutional or block)
 - A: Two Viterbi decoders are required:
 - one Viterbi decoder provides WLAN compatibility mode, using the standard (2,1,7) code; this is a 64-state decoder and could be hard decision, which, together with the fact that code puncturing is not used, yields a decoder about 40% of the complexity of that required for a full WLAN implementation. This yields an approx complexity 25k gates.
 - one soft-decision Viterbi decoder for the WPAN high rate mode, using a (3,2,3) TCM code, is a 4-state decoder only with short decision depth and has very low complexity

4.1 Size and Form Factor - New criteria (cont.)

- (2) Baseband functionality/size (cont.)
 - **Q:** CMOS chip area, gate count and process technology
 - **A:** The chip area for the modem including A/Ds and D/As is estimated to be less than 14 mm^2 in 0.18 μ CMOS technology. Gate count is approximately 130k gates (approx 90k for WPAN mode plus additional 40k gates for WLAN compatibility modes). This estimate is obtained by scaling from an existing chip implementation of the IEEE

- (3) Total number of chips and external components for the overall PHY solution
 - Two chips are required for a full PHY solution: one modem and one transceiver. Note also that the modem and MAC could readily be implemented as a single chip from the outset. Additional components are a clock oscillator and passive components only, including VCO filters, power supply bypass capacitors and ferrite beads, D/A output biasing resistors, 5 GHz output stage matching circuit, Rx and Tx IF filters (one SAW, one probably passive ladder filter).

4.2 PHY Throughput

Delivered data throughputs (after MAC and PHY overheads are subtracted) are 20.4 Mbit/s (D8PSK TCM) and 28.0 Mbit/s (D8PSK uncoded) for 512 byte payloads

Data Rate Mbit/s	Modulation/ Code	Coding rate
6,0	BPSK (2,1,7)	1/2
12,0	QPSK (2,1,7)	1/2
14,4	DQPSK (2,1,7)	1/2
21,7	D8PSK(2,1,7)	1/2
28,9	D8PSK trellis (4s)	2/3
43,3	D8PSK uncoded	1

4.3 Frequency Band

Same as 802.11a - 5GHz U-NII bands

- The 5 GHz Unlicensed National Information Infrastructure bands are
 - low band 5.15-5.25 GHz
 - mid band 5.25-5.35 GHz
 - high band 5.725-5.825 GHz

4.4 Number of Simultaneously Operating Full Throughput PANs

Twelve full rate simultaneously operating PANs can operate in one POS;
OR

We can almost tile the world twice over with 28.9 Mbit/s full rate PANs.

- Co-channel interference limits determine a minimum distance before a channel can be reused
- Reuse distance depends on the rate of increase of path attenuation with distance
- For a path loss exponent of 3.1 and hexagonal cells,
 - 10 channels are required for 43.3 Mbit/s D8PSK uncoded mode
 - 7 channels are required for 28.9 Mbit/s D8PSK $R=2/3$ trellis coded mode

4.5 Signal Acquisition Method

The system requires AGC, coarse timing sync and coarse frequency acquisition. It avoids the need for fine lock by the use of only differential modulation

- AGC based on fast RSSI and receiver gain control performed digitally well within the A16 preamble sequence
- coarse timing and frequency acquisition using A16 symbols
- differential phase reference provided by D64 symbol (with its D8 cyclic extension)

4.6 Range

Range for 1mW Tx power, 0 dBi Tx antenna gain, 0 dBi Rx antenna gain, 7 dB Rx NF and path loss based on ITU P.1238 exceeds 10 m for all rates

- Range for 14.4 Mbit/s signal field exceeds 20m
- Range for 28.9 Mbit/s link exceeds 13m
- Range for 43.3 Mbit/s link exceeds 10m
- (see earlier tables)
- *ITU-R Recommendation P.1238 (1997) - PROPAGATION DATA AND PREDICTION MODELS FOR THE PLANNING OF INDOOR RADIOCOMMUNICATION SYSTEMS AND RADIO LOCAL AREA NETWORKS IN THE FREQUENCY RANGE 900 MHz TO 100 GHz*

– The basic model has the following form:

$$L_{total} = 20 \log_{10} f + N \log_{10} d + L_f(n) - 28 \quad \text{dB} \quad (1)$$

– where:

- N : distance power loss coefficient
- f : frequency (MHz)
- d : separation distance (m) between the base station and portable
- L_f : floor penetration loss factor (dB)
- n : number of floors between base and portable.

4.6 Range and C/I measurements for PER of 10^{-2} achieved 90% of the frames

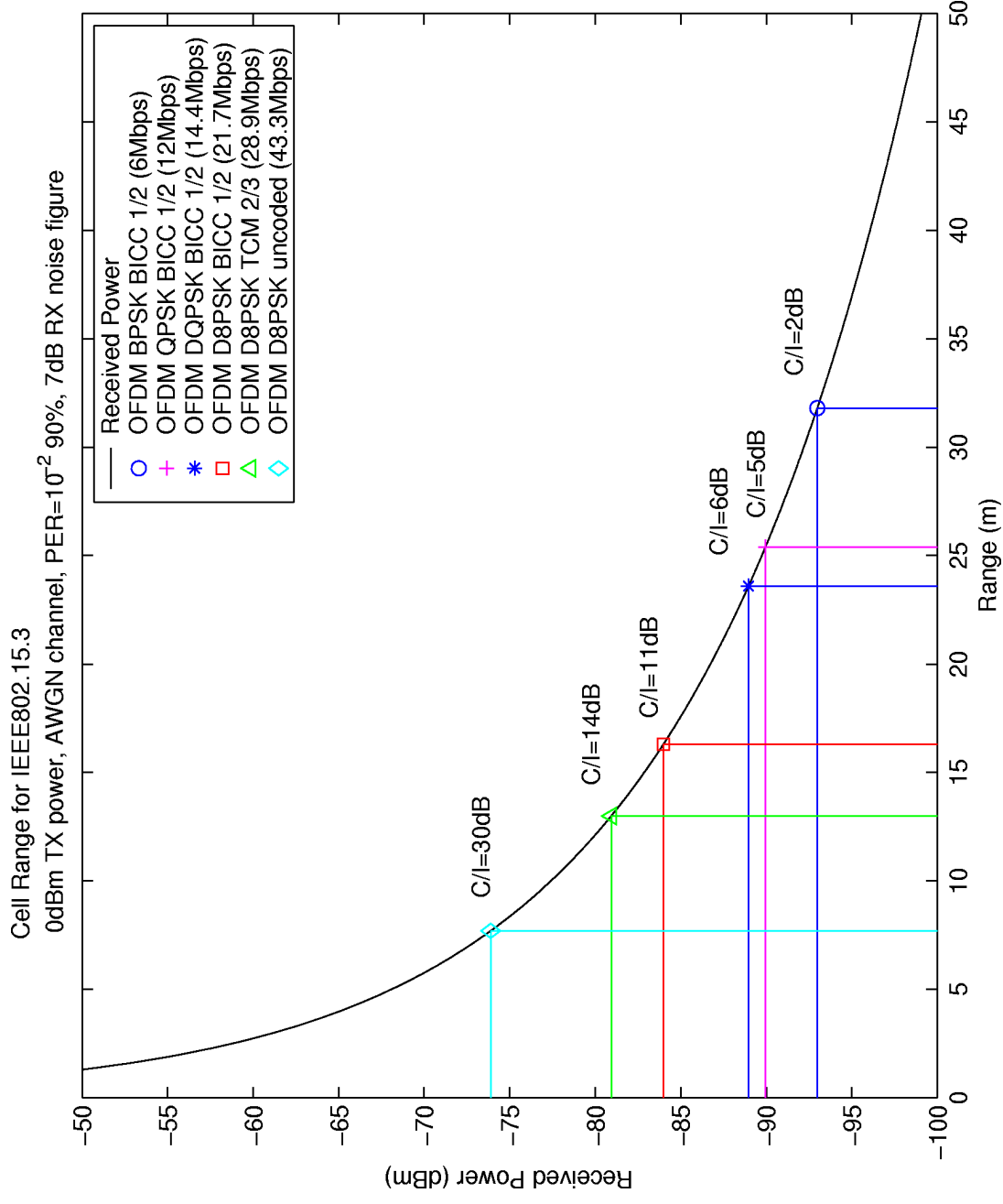

4.7 Sensitivity

Minimum sensitivity is -78 dBm

- The minimum sensitivity for the coded modulation at a BER of $1e-5$ (a PER ~1%) is -78 dBm.
- This includes a NF of 7dB and an implementation loss of 1 dB and measurement at the antenna connection point

4.8 Multipath Immunity

The delay spread tolerance is better than $T_{rms} = 50\text{ns}$

- **4.8.2. Delay Spread Tolerance**
 - Guard time (or cyclic prefix) is of length 400ns ie immunity is granted for multipath up to 400ns before observing intersymbol interference (Inter-carrier interference)
 - This will give at least $T_{rms} = 50\text{ns}$ for an exponentially decaying model

4.8 Multipath Immunity

Channel with Trms = 25ns generated according to environment exponential model in section 4.8.1

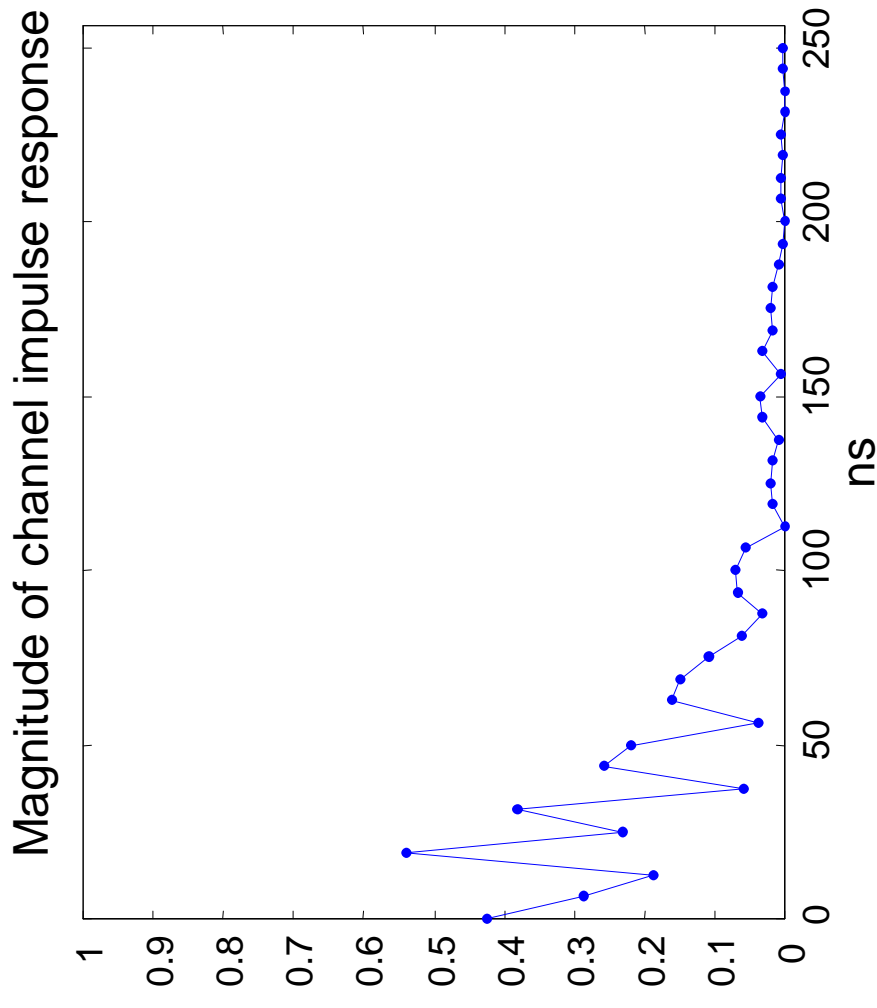

BER Performance (504 bytes packets, 5000 packets TX)

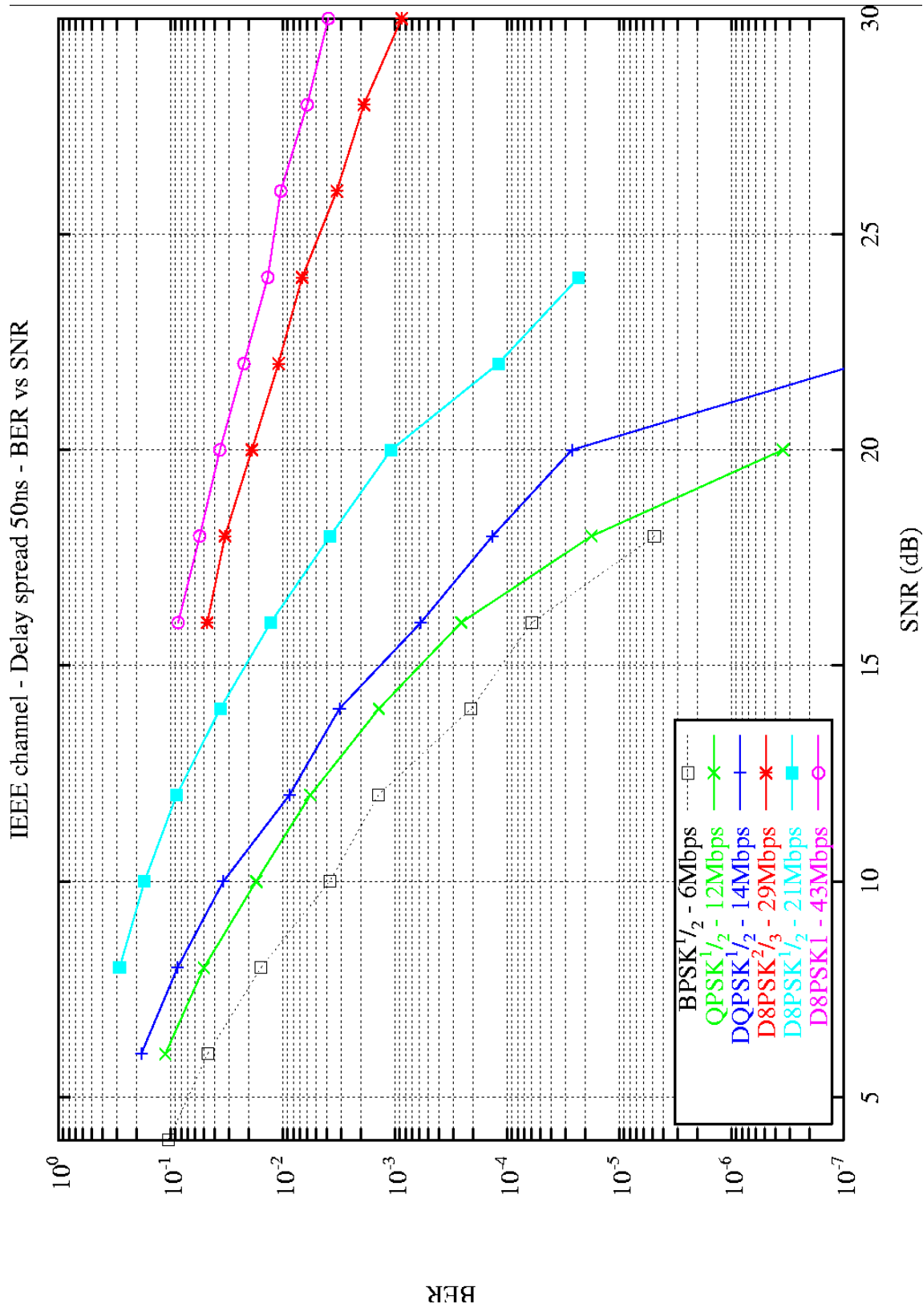

4.9 Power Consumption

Peak power is ~1.2W Receive and 1W Transmit based on a current implementation. Circuit optimization and process improvements can yield major power savings. Average power is reduced substantially by MAC power saving modes - factor may be 10 or more.

<i>Rx (mW)</i>	<i>Tx (mW)</i>	<i>2000 est</i>
177		RF Rx
	207	RF Tx
99	99	VCOs
	126	Baseband Tx
153		Baseband Rx
300		ADCs
	40	DACs
200	200	RAM
300	300	MAC
1229	972	Total mW

HIPERPAN evaluation matrix: general criteria

CRITERIA	Comparison Values	
	-	+
Unit Manufacturing Cost (\$) as a function of time (when product delivers) and volume	> 2 x equivalent Bluetooth 1	< 1.5 x equivalent Bluetooth 1
Interference and Susceptibility	<p><i>Out of the proposed band:</i> Worse performance than same criteria</p> <p><i>In band:</i> -: Interference protection is less than 25 dB (excluding co-channel and adjacent channel)</p>	<p><i>Out of the proposed band:</i> Better performance than same criteria</p> <p><i>In band:</i> Interference protection is less greater than 35 dB (excluding co-channel and adjacent channel)</p>
Intermodulation Resistance	< -45 dBm	-35 dBm to -45 dBm
Jamming Resistance	Any 2 devices listed jam	Handle Microwave, 802.15.1 (2 scenarios) and 802.15.3
Multiple Access	No Scenarios work	Handles Scenario 2

CRITERIA	Comparison Values	
	-	+
Coexistence (Evaluation for each of the 5 sources and the create a total value using the formula shown in note #3)	Individual Sources: 0% Total: < 3	Individual Sources: 50% Total: 3
Interoperability	False	N/A
Manufactureability	Expert opinion, models	Pre-existence examples, demo
Time to Market	Available after 1Q2002	Available earlier than 1Q2002
Regulatory Impact	False	N/A
Maturity of Solution	Expert opinion, models	Pre-existence examples, demo
Scalability	Scalability in 1 or less than of the 5 areas listed	Scalability in 3 or more of the 5 areas listed

CRITERIA	Comparison Values		
	-	Same	+
Size and Form Factor	Larger	Compact Flash Type I card	Smaller
Minimum MAC/PHY Throughput	20 Mbps (without MAC overhead)	20 Mbps + MAC overhead	> 20 Mbps
High End MAC/PHY Throughput (Mbps)	20 – 39 Mbps	40 Mbps + MAC overhead	> 40 Mbps
Frequency Band	N/A (not supported by PAR)	Unlicensed	N/A (not supported by PAR)
Number of Simultaneously Operating Full-Throughput PANs	< 4	4	> 4
Signal Acquisition Method	N/A	N/A	N/A
Range	< 10 meters	≥ 10 meters	N/A
Sensitivity	N/A	N/A	N/A
Delay Spread Tolerance	< 10 ns	25 ns	> 50 ns
Power Consumption (the peak power of the PHY combined with an appropriate MAC)	> 1.5 watts	Between .5 watt and 1.5 watts	< .5 watt

General conclusion:
revised self rating
proposal

00245r6P802-15_TG3-Proposal-Evaluations		Day/Time in La Jolla	TU 8:30
		Presenter/Doc Owner	Motorola/Radiata
		Proposal Type	PHY
		PPT/Doc	196r3
Criteria Ref.	Criteria		
General Solution			
2.1	Unit Manufacturing Cost		0
2.2.2	Interference and Susceptibility		0
2.2.3	Intermodulation Resistance		1
2.2.4	Jamming Resistance		1
2.2.5	Multiple Access		1
2.2.6	Coexistence		1
2.3	Interoperability		-1
2.4.1	Manufactureability		1
2.4.2	Time to Market		1
2.4.3	Regulatory Impact		0
2.4.4	Maturity of Solution		1
2.5	Scalability		1
2.6	Location Awareness		0
PHY			
4.1	Size and Form Factor		1
4.2.1	Minimum MAC/PHY Throughput		1
4.2.2	High End MAC/PHY Throughput		1
4.3	Frequency Band		0
4.4	Number of Simultaneously Operating Full-Throughput PANS		1
4.5	Signal Acquisition Method		0
4.6	Range		0
4.7	Sensitivity		0
4.8.2	Delay Spread Tolerance		1
4.9	Power Consumption		1
		Total -'s	1
		Total 0's	8