

**Project: IEEE P802.15 Working Group for Wireless Personal Area Networks (WPANs)**

**Submission Title:** [XtremeSpectrum CFP Presentation]

**Date Submitted:** [July 2003]

**Source:** [Matt Welborn] Company [XtremeSpectrum, Inc.]

Address [8133 Leesburg Pike, Suite 700, Vienna, Va. 22182, USA]

Voice:[+1 703.269.3000], FAX: [+1 703.749.0248], E-Mail:[mwelborn@xtremespectrum.com]

**Re:** [Response to Call for Proposals, document 02/372r8]

**Abstract:** []

**Purpose:** [Summary Presentation of the XtremeSpectrum proposal. Details are presented in document 03/154 along with proposed draft text for the standard.]

**Notice:** This document has been prepared to assist the IEEE P802.15. It is offered as a basis for discussion and is not binding on the contributing individual(s) or organization(s). The material in this document is subject to change in form and content after further study. The contributor(s) reserve(s) the right to add, amend or withdraw material contained herein.

**Release:** The contributor acknowledges and accepts that this contribution becomes the property of IEEE and may be made publicly available by P802.15.

## Compliant Frequency Hoppers suffer degraded performance under current FCC UWB Rules<sup>1</sup>

- FCC has expressed deep reservations about FH systems at every stage of UWB proceeding.
  - To date, no interference studies have been done using FH modulations.
  - FCC's Part 15 rules on FH UWB are clear on their face:
    - A UWB frequency hopper must be tested for compliance with the **hopping turned off** and the signal "parked" or held stationary at one band of frequencies. (First R&O at para. 32.)
    - The bandwidth must be at least 500 MHz with the hopping turned off.
    - The device must comply with the emissions limits with the hopping turned off.
- Result: The performance of compliant FH systems is seriously degraded because a hopper is NOT allowed to put as much energy as a non-hopper (both covering the same total range of frequencies).**
- The maximum permitted power is reduced in proportion to the number of hops
  - $N$  = number of hops
  - Range is reduced by  $1/\sqrt{N}$  assuming  $1/R^2$  propagation
  - Data-rate is reduced by  $1/N$  assuming all else is equal.
  - Example - 10 m range is reduced to 5.8 m range using three hops

Note 1: Reference doc IEEE802.15-03/271

## Illustration of how to test a compliant UWB FH radio

With Hopping turned OFF:

1. Bandwidth here must meet FCC UWB definition of  $> 500$  MHz bandwidth; AND
2. W/MHz emissions must be within all emission limits defined in the rules

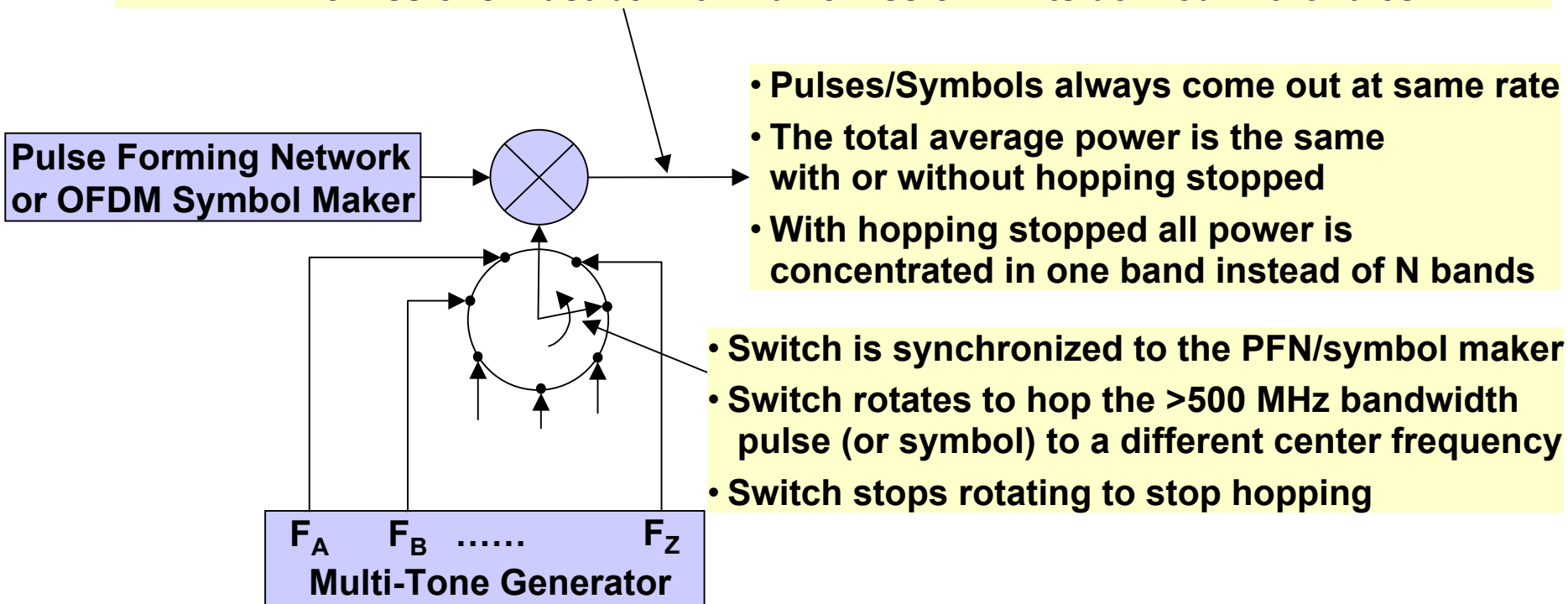

**A compliant FH system has only  $1/N$  th the power of a non-hopping system so that it meets the emission limits with hopping turned off**

# Timing versus Power and Frequency Diagrams

July 2003

for frequency hoppers

doc.: IEEE 802.15-03/153r7

## Hopping on (normal operation)

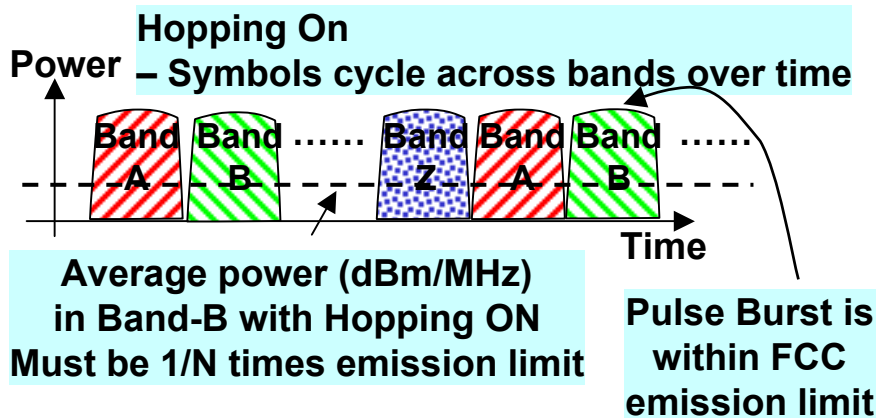

## Hopping off (for compliance testing)

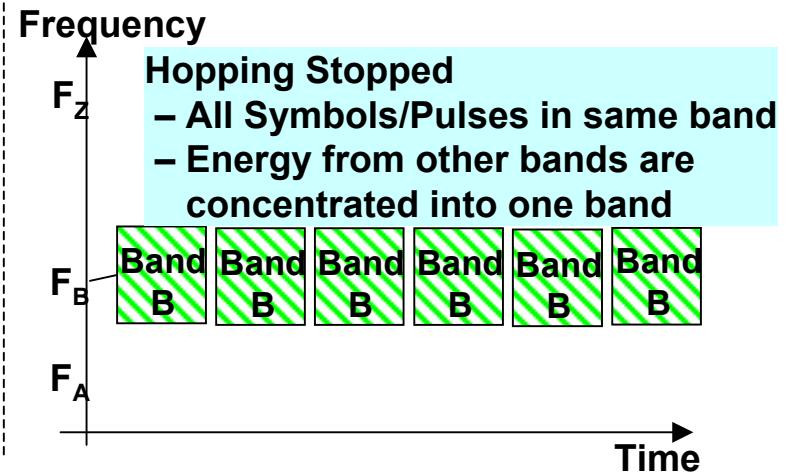
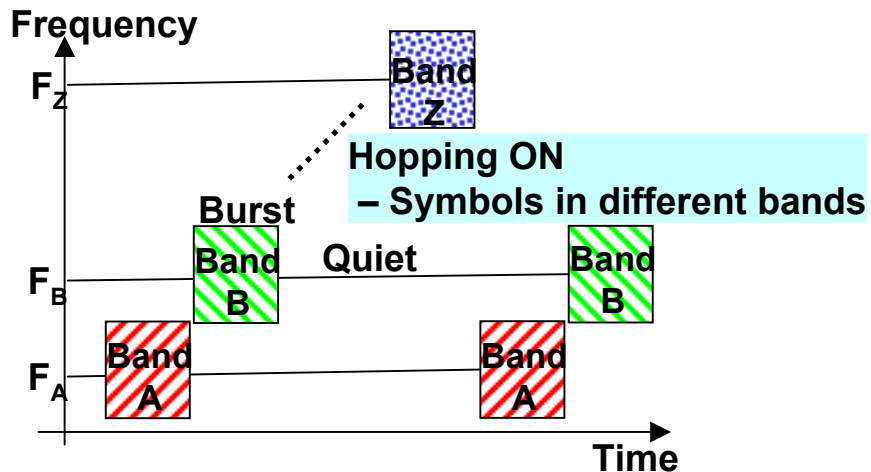
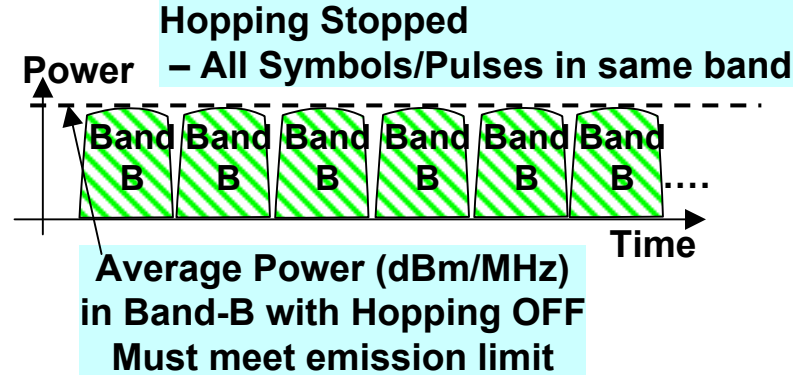

**Turning hopping off concentrates the energy so a compliant FH system has only 1/N th the power of a non-hopping system**

# Power versus Frequency Diagrams

July 2003

For Frequency Hoppers

doc.: IEEE 802.15-03/153r7

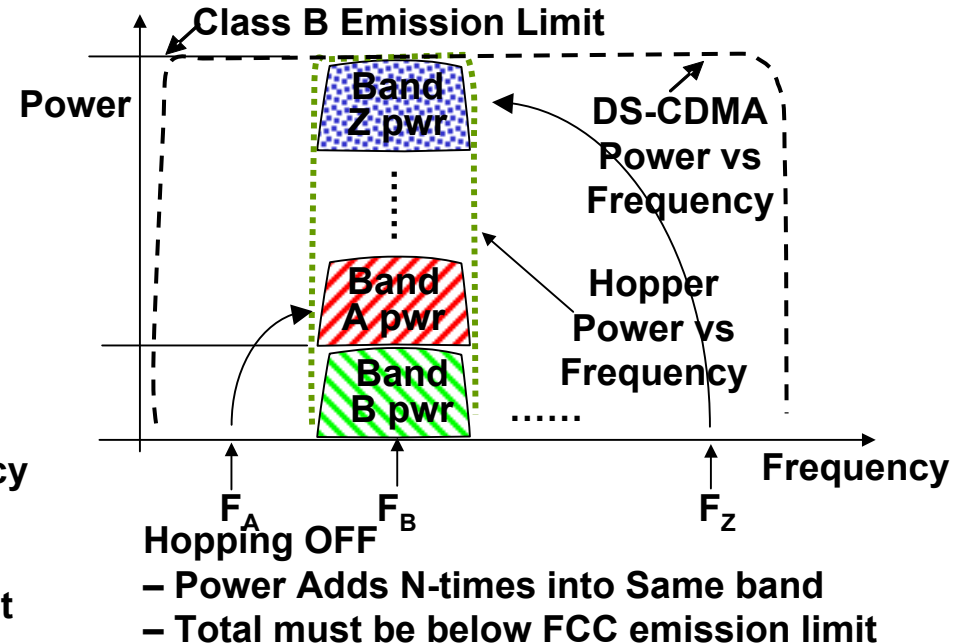
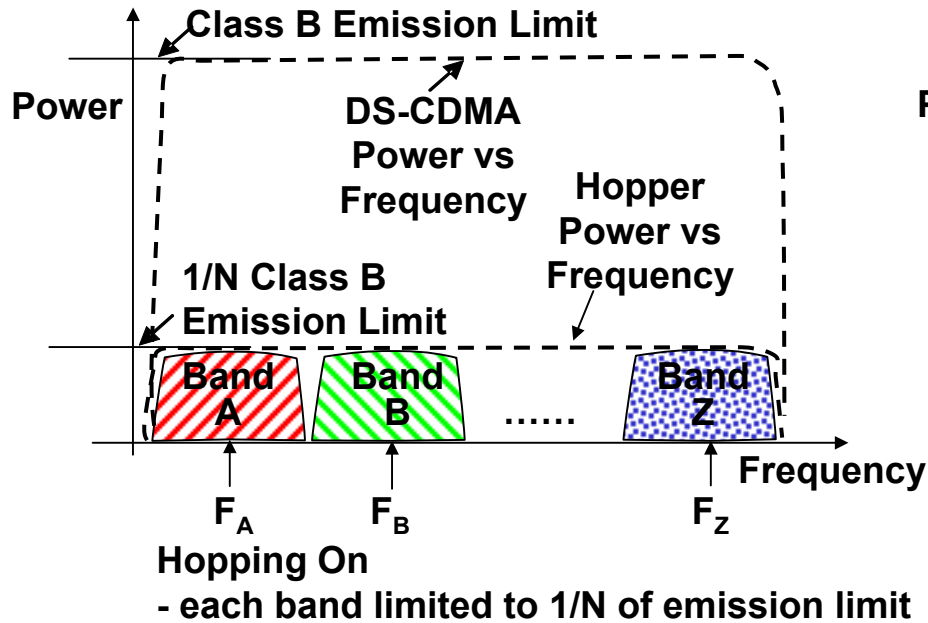

FH systems have only  $1/N$  th the power of a non-hopping systems

**The performance of FH systems is seriously degraded.**

$N$ =number of hops

Range is reduced by  $1/\sqrt{N}$  assuming  $1/R^2$  propagation

Data-rate is reduced by  $1/N$  assuming all else is equal.

Example - 10 m range is reduced to 5.8 m range using three hop system

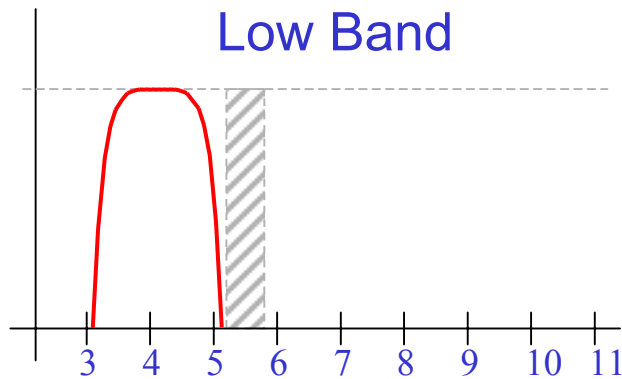

- **Low Band (3.1 to 5.15 GHz)**
  - 28.5 Mbps to 400 Mbps
  - Supports low rate, longer range services

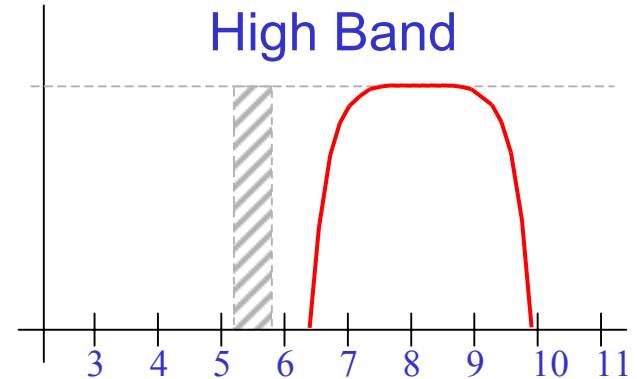

- **High Band (5.825 to 10.6 GHz)**
  - 57 Mbps to 800 Mbps
  - Supports high rate, short range services

**3 Spectral Modes of Operation**

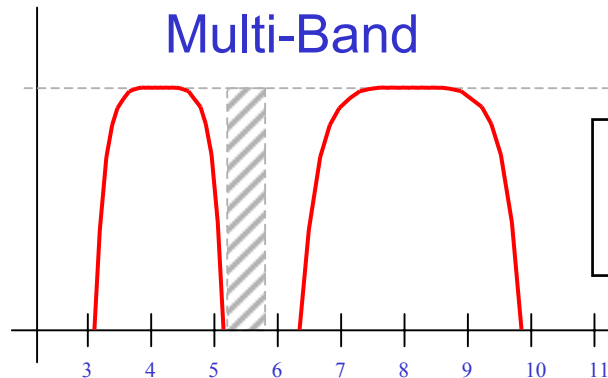

With an appropriate diplexer, the multi-band mode will support full-duplex operation (RX in one band while TX in the other)

- **Multi-Band (3.1 to 5.15 GHz plus 5.825 GHz to 10.6 GHz)**
  - Up to 1.2 Gbps
  - Supports low rate, longer range, high rate, short range services

- PHY Proposal accommodates alternate spectral allocations
  - Center frequency and bandwidth are adjustable
  - Supports future spectral allocations
  - Maintains UWB advantages (i.e. wide bandwidth for multipath resolution)
  - **No changes to silicon**

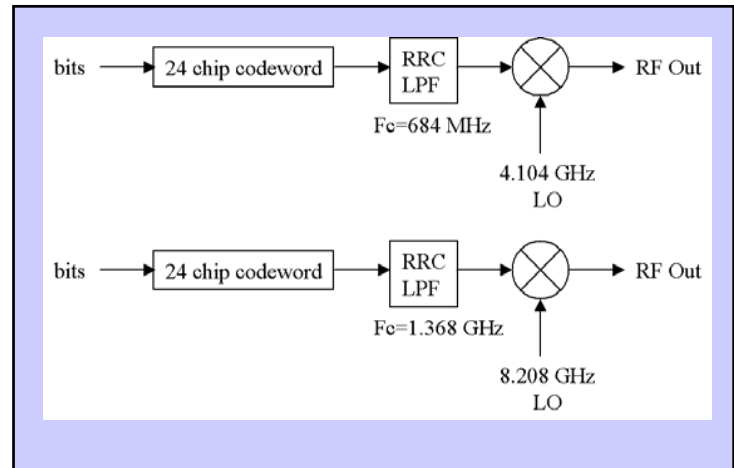

Example 2: Support for hypothetical “above 6 GHz” UWB definition

Example 1: Modified Low Band to include protection for 4.9-5.0 GHz WLAN Band

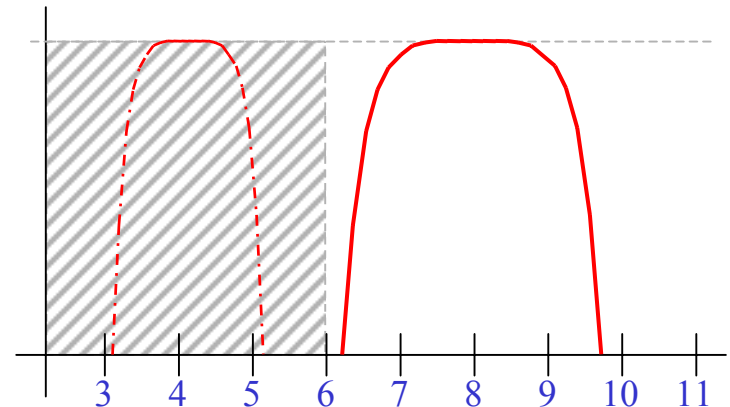
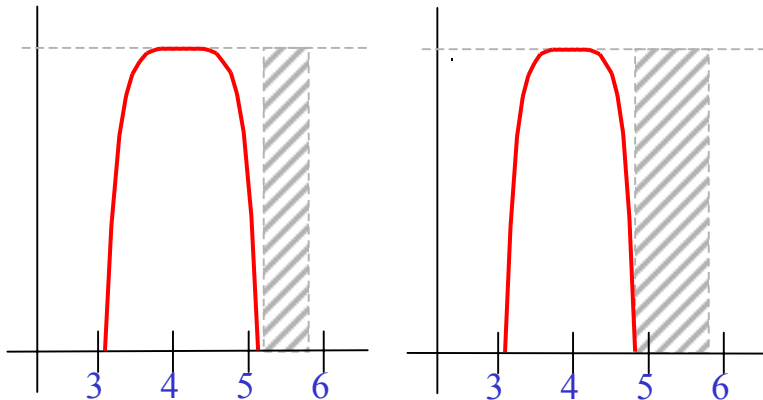

Note 1: Reference doc IEEE802.15-03/211

Multi-piconet capability via:

- FDM (Frequency)
  - Choice of one of two operating frequency bands
  - Alleviates severe near-far problem
- CDM (Code)
  - 4 CDMA code sets available within each frequency band
  - Provides a selection of logical channels
- TDM (Time)
  - Within each piconet the 802.15.3 TDMA protocol is used

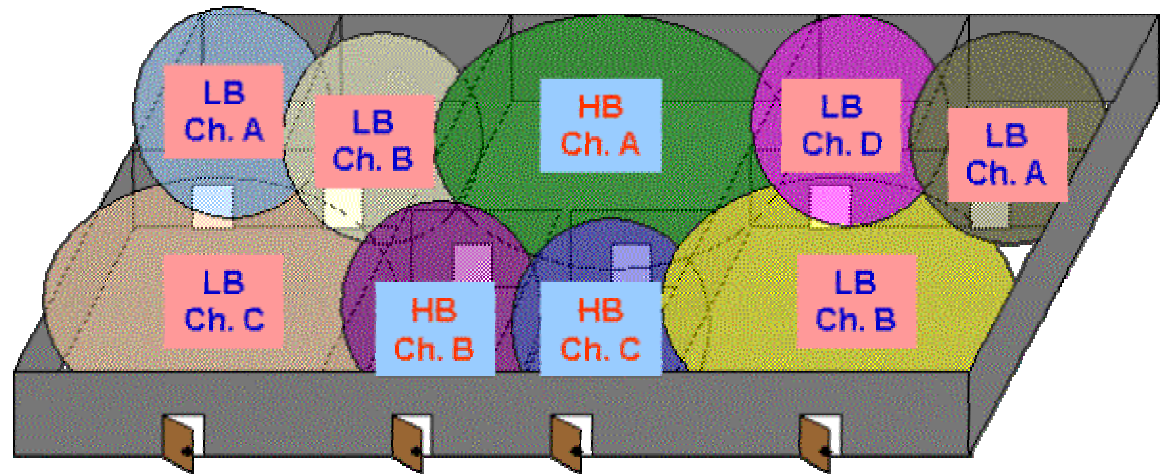
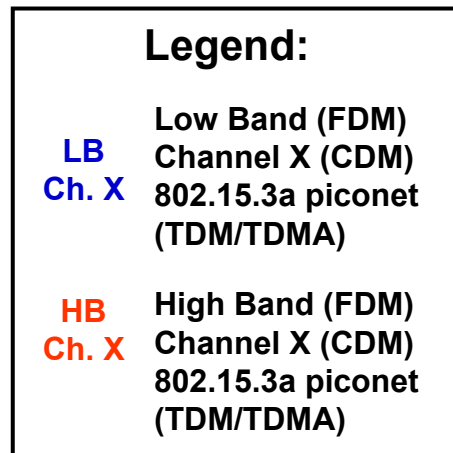

An environment depicting multiple collocated piconets



## Why a Multi-Band CDMA PSK Approach?

- Support simultaneous full-rate piconets
- Low cost, low power
- Uses existing 802.15.3 MAC
  - No PHY layer protocol required
- Time to market
  - Silicon in 2003

**This PHY proposal is based upon proven and common communication techniques**

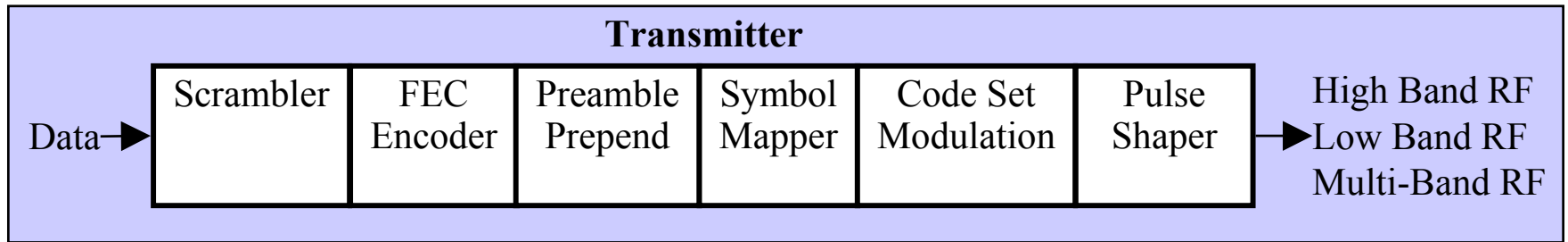

- **Multiple bits/symbol via MBOK coding**
- **Data rates from 28.5 Mbps to 1.2 Gbps**
- **Multiple access via ternary CDMA coding**
- **Support for CCA by exploiting higher order properties of BPSK/QPSK**
- **Operation with up to 8 simultaneous piconets**

- Scrambler (15.3 scrambler)
  - Seed passed as part of PHY header

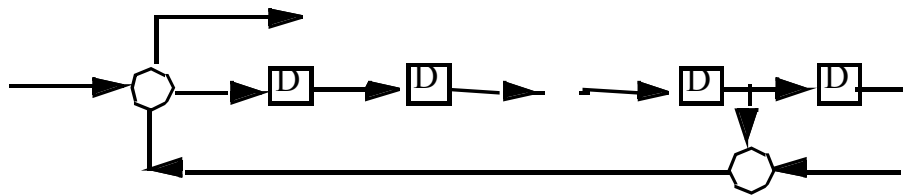

$$g(D) = 1 + D^{14} + D^{15}$$

- Forward error correction options
  - Convolutional FEC code (<200 Mbps – 2002 technology)
    - $\frac{1}{2}$  rate  $K=7$ , (171, 133) with  $\frac{2}{3}$  and  $\frac{3}{4}$  rate puncturing
    - Convolutional interleaver
  - Reed-Solomon FEC code (high rates)
    - RS(255, 223) with byte convolutional interleaver
  - Concatenated FEC code (<200 Mbps – 2002 technology)

- Approach uses tested direct-sequence spread spectrum techniques
- Pulse filtering/shaping used with BPSK/QPSK modulation
  - 50% excess bandwidth, root-raised-cosine impulse response
- Harmonically related chipping rate, center frequency and symbol rate
  - Reference frequency is 684 MHz

	<b>RRC BW</b>	<b>Chip Rate</b>	<b>Code Length</b>	<b>Symbol Rate</b>
<b>Low Band</b>	1.368 GHz	1.368 GHz ( $\pm 1$ MHz, $\pm 3$ MHz)	24 chips/symbol	57 MS/s
<b>High Band</b>	2.736 GHz	2.736 GHz ( $\pm 1$ MHz, $\pm 3$ MHz)	24 chips/symbol	114 MS/s

- CDMA via low cross-correlation *ternary* code sets ( $\pm 1, 0$ )
- Four logical piconets per sub-band (8 logical channels over 2 bands)
- Up to 16-BOK per piconet (4 bits/symbol bi-phase, 8 bits/symbol quad-phase)
  - 1 sign bit and 3 bit code selection per modulation dimension
  - 8 codewords per piconet
- Total number of 24-chip codewords (each band):  $4 \times 8 = 32$ 
  - RMS cross-correlation  $< -15$  dB in a flat fading channel
- CCA via higher order techniques
  - Squaring circuit for BPSK, fourth-power circuit for QPSK
  - Operating frequency detection via collapsing to a spectral line
- Each piconet uses a unique center frequency offset
  - Four selectable offset frequencies, one for each piconet
    - +/- 3 MHz offset, +/- 9 MHz offset

## Scaleable power/cost/performance Adaptable to broad application classes

### Symbol Rate ADC

*Simple/cheap Analog Emphasis*

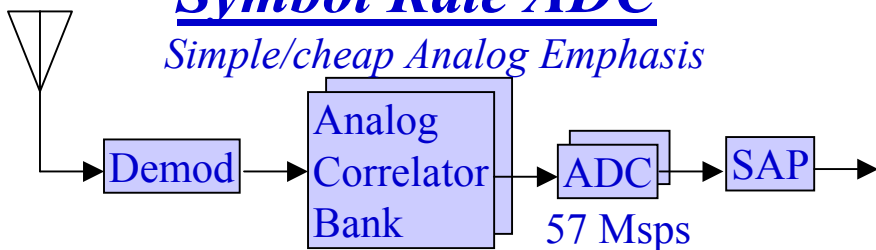

### Chip Rate ADC

*Higher Performance some DSP-capable*

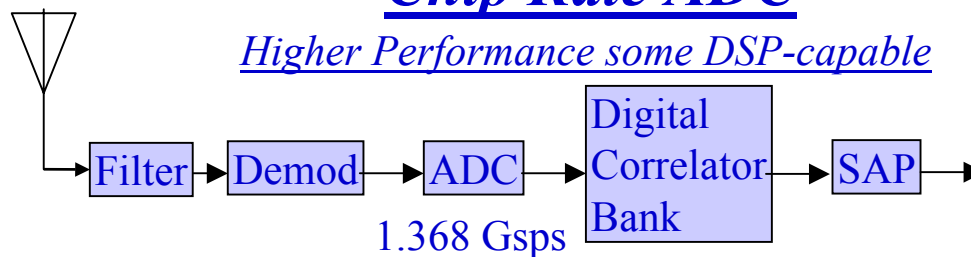

### RF Nyquist Rate ADC

*Highest Performance most DSP-capable*

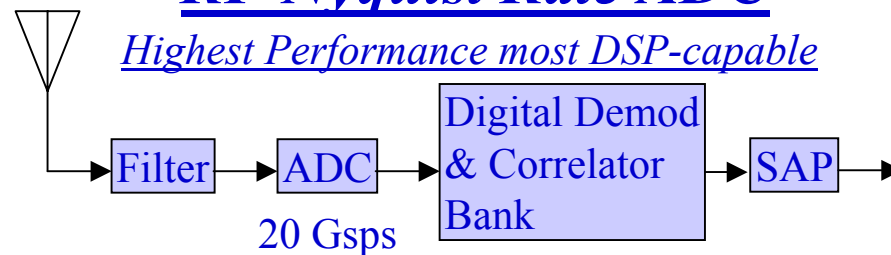

PNC1 =

-1	1	-1	-1	1	-1	-1	1	-1	0	-1	0	-1	-1	1	1	1	-1	1	1	1	-1	-1	-1
0	-1	-1	0	1	-1	-1	1	-1	-1	1	1	1	1	-1	-1	1	-1	1	-1	1	1	1	1
-1	-1	-1	-1	1	-1	1	-1	1	-1	-1	1	-1	-1	1	-1	-1	1	1	0	-1	0	1	1
0	-1	1	1	1	-1	-1	-1	-1	-1	-1	-1	1	-1	1	-1	0	1	-1	1	1	-1	-1	1
-1	0	1	-1	-1	-1	1	1	0	1	1	1	1	-1	1	-1	1	1	1	-1	1	-1	-1	1
-1	0	-1	1	-1	1	-1	-1	0	1	1	1	1	-1	1	1	-1	-1	-1	1	1	-1	1	1
-1	-1	-1	-1	-1	-1	1	1	1	0	-1	-1	1	1	-1	1	-1	1	-1	1	1	-1	0	1
-1	1	-1	-1	-1	1	-1	-1	0	-1	1	-1	-1	1	-1	0	1	1	1	1	-1	-1	-1	1

2-BOK uses code 1  
 4-BOK uses codes 1 & 2  
 8-BOK uses codes 1,2,3 &4  
 16-BOK uses all codes

PNC2 =

-1	-1	1	0	1	1	1	-1	-1	1	-1	1	1	-1	1	0	1	-1	-1	-1	1	-1	-1	-1
-1	-1	-1	1	-1	-1	-1	1	0	1	-1	1	1	-1	1	-1	-1	1	1	1	0	1	-1	-1
-1	1	-1	1	1	-1	1	0	1	1	1	-1	-1	1	1	-1	1	1	1	-1	-1	-1	0	-1
0	-1	1	1	1	1	-1	-1	1	1	1	-1	1	1	-1	1	1	1	-1	1	-1	0	-1	-1
-1	1	-1	1	-1	-1	-1	-1	-1	-1	-1	1	1	1	-1	-1	1	1	-1	0	1	-1	0	1
-1	1	-1	-1	1	0	-1	-1	1	1	-1	-1	0	1	1	1	-1	-1	-1	-1	-1	1	-1	1
-1	0	1	-1	-1	-1	1	-1	1	-1	1	1	1	1	-1	-1	-1	-1	1	-1	0	1	-1	-1
-1	-1	-1	-1	-1	-1	1	1	1	0	-1	1	-1	1	-1	1	1	-1	-1	1	-1	0	1	-1

PNC3 =

-1	1	-1	1	-1	-1	0	1	-1	-1	-1	1	-1	-1	1	0	-1	-1	-1	-1	1	1	1	1
-1	-1	1	1	-1	-1	-1	-1	-1	-1	1	1	0	1	-1	1	1	-1	1	-1	0	-1	1	-1
-1	-1	-1	1	1	1	-1	-1	-1	1	-1	-1	-1	1	-1	-1	1	-1	1	0	1	1	0	1
-1	-1	1	-1	-1	1	1	1	-1	-1	1	-1	-1	-1	-1	0	1	1	-1	1	-1	1	0	1
-1	-1	-1	1	-1	1	-1	1	0	-1	-1	-1	1	1	1	1	-1	1	1	-1	0	1	-1	-1
-1	-1	-1	0	-1	-1	-1	-1	1	1	1	0	1	-1	-1	1	-1	1	-1	1	1	-1	-1	1
-1	1	-1	1	-1	1	1	0	1	1	1	0	-1	1	1	-1	1	1	-1	-1	-1	-1	1	1
-1	1	0	-1	1	-1	1	-1	-1	-1	1	-1	-1	0	1	-1	-1	1	1	1	1	-1	-1	-1

PNC4 =

-1	-1	1	1	1	-1	-1	-1	-1	-1	-1	0	-1	1	-1	1	-1	1	1	-1	1	1	-1	0
-1	-1	-1	1	-1	1	1	1	1	-1	1	1	-1	1	1	-1	-1	1	1	1	0	0	-1	1
-1	1	-1	1	1	1	1	0	-1	-1	-1	-1	1	-1	0	-1	-1	1	1	-1	-1	1	1	-1
0	-1	-1	-1	-1	-1	-1	1	1	0	-1	1	1	-1	1	-1	-1	1	1	-1	1	-1	1	-1
-1	-1	1	1	-1	-1	1	0	-1	1	1	1	1	-1	1	-1	1	-1	0	-1	1	1	1	1
-1	-1	1	-1	-1	1	-1	-1	0	-1	1	-1	1	1	-1	-1	1	-1	0	-1	1	1	1	1
-1	1	0	1	-1	-1	-1	1	1	-1	0	-1	1	-1	-1	1	-1	1	1	1	1	1	1	1
-1	-1	-1	-1	1	-1	1	0	-1	1	-1	1	1	1	0	1	-1	-1	1	1	-1	-1	1	1



	2-BOK	4-BOK	8-BOK	16-BOK
Spectral Pk-to-Avg Backoff	2.2 dB	2.1 dB	1.7 dB	1.3 dB

Worst Case Synchronized Cross-correlation Coefficient within a group	2/22
Average RMS Cross Correlation between groups	channel dependent but generally looks like $10 \cdot \log_{10}(1/24)$ noise due to center frequency offset and chipping rate frequency offset

- RX Link Budget (more detail in rate-range slides)
  - 114 Mbps @ 21.6 meters (Low Band in AWGN)
    - 6.7 dB margin at 10 meters
    - Acquisition range limited at 18.7 meters
    - RX Sensitivity of  $-82.7$  dBm @ 4.2 dB noise figure
  - 200 Mbps @ 15.8 meters (Low Band in AWGN)
    - 4.0 dB margin at 10 meters
    - 11.9 dB margin at 4 meters
    - Not acquisition range limited
    - RX Sensitivity of  $-79.6$  dBm @ 4.2 dB noise figure
  - 600 Mbps @ 4.9 meters (High Band in AWGN)
    - 1.7 dB margin at 4 meters
    - Not acquisition range limited
    - RX Sensitivity of  $-72.7$  dBm @ 5.1 dB noise figure

# Noise Figure Budget & Receiver Structure

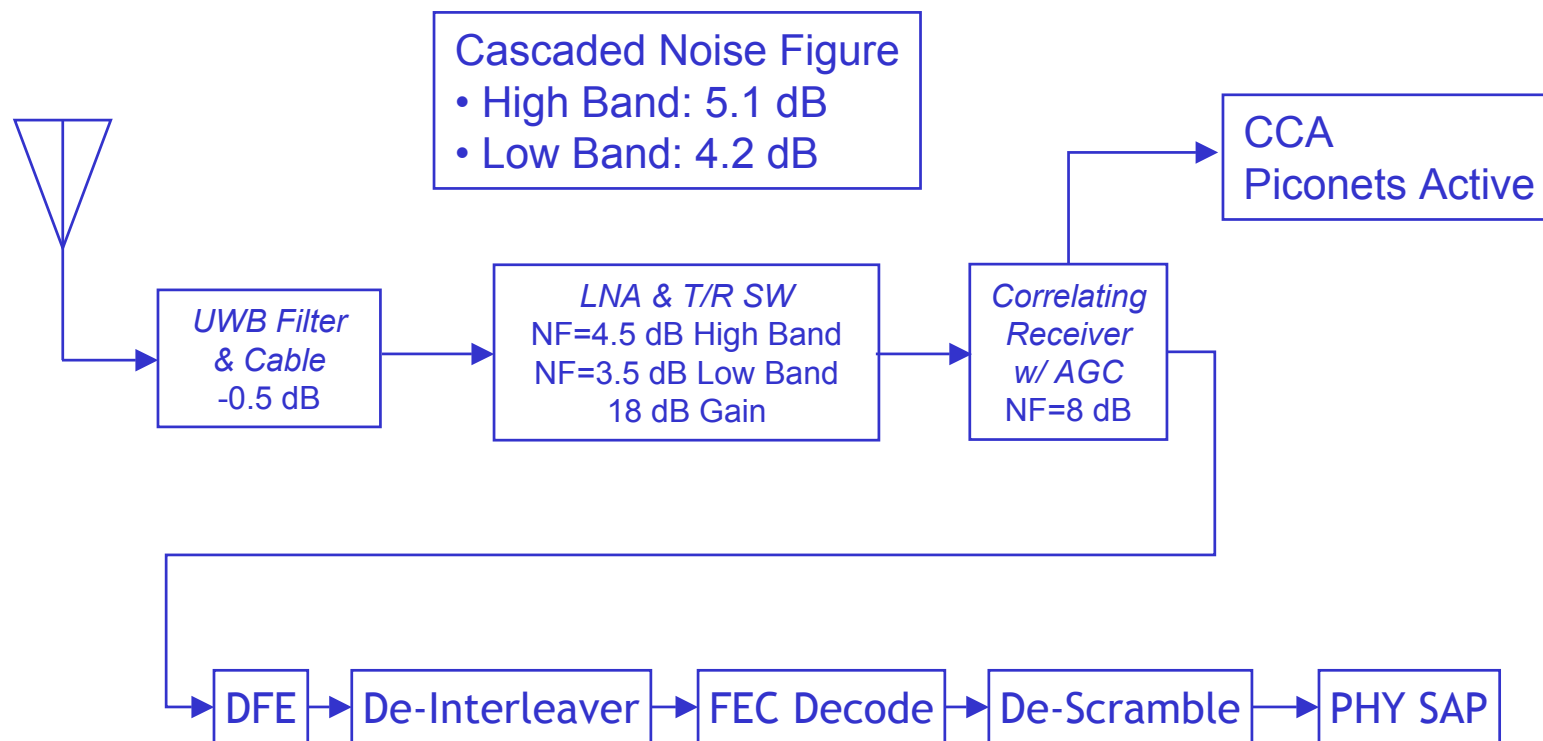

# Low Band Symbol Rates and Link Budget

July 2003

doc.: IEEE 802.15-03/153r7

Txpow=-9.9 dBm; Coded Eb/No=9.6 dB, 3 dB implementation loss, 0 dB RAKE gain, NF=4.2 dB, 1/2 rate code gain: 5.2 dB, 2/3 rate code gain: 4.7 dB, 3/4 rate code gain: 4 dB, RS code gain: 3 dB, concatenated gain: 6.3 dB, 8-BOK coding gain: 1.4 dB, 16-BOK coding gain: 2.4 dB, 2-BOK PSD Backoff: 2.2 dB, 4-BOK PSD Backoff: 2.1 dB, 8-BOK PSD Backoff: 1.7 dB, 16-BOK PSD Backoff: 1.3 dB

Rate	Modulation	CDMA Code Type	FEC	Fc GHz <sup>1</sup>	Range AWGN	Acquisition Range	10 meter margin	RX Sensitivity <sup>2</sup>
28.5 Mbps	BPSK	2-BOK (1 bits/symbol)	1/2 rate convolutional	4.0	36.8 meters	16.7 meters	11.3 dB	-87.9 dBm
57 Mbps	BPSK	4-BOK (2 bits/symbol)	1/2 rate convolutional	4.0	26.3 meters	16.9 meters	8.4 dB	-84.8 dBm
75 Mbps	BPSK	8-BOK (3 bits/symbol)	Concatenated	4.0	32.1 meters	17.7 meters	10.1 dB	-86.2 dBm
100 Mbps	BPSK	4-BOK (2 bits/symbol)	RS(255, 223)	4.0	15.5 meters	>15.5 meters	3.8 dB	-80.2 dBm
114 Mbps	BPSK	8-BOK (3 bits/symbol)	2/3 rate convolutional	4.0	21.6 meters	17.7 meters	6.7 dB	-82.7 dBm
200 Mbps (199.4 Mbps)	BPSK	16-BOK (4 bits/symbol)	RS(255, 223)	4.0	15.8 meters	>15.8 meters	4.0 dB	-79.6 dBm
400 Mbps (398.8 Mbps)	QPSK	16-BOK (8 bits/symbol)	RS(255, 223)	4.0	11.2 meters	>11.2 meters	1.0 dB	-76.6 dBm

<sup>1</sup> Center frequency determined as geometric mean in accordance with 03031r9, clause 5.6

<sup>2</sup> Based upon corrected Eb/No of 9.6 dB after application of all coding gain

## Coding Gain References:

- <http://www.intel.com/design/digital/STEL-2060/index.htm>
- [http://grouper.ieee.org/groups/802/16/tg1/phy/contrib/802161pc-00\\_33.pdf](http://grouper.ieee.org/groups/802/16/tg1/phy/contrib/802161pc-00_33.pdf)

*Table is representative - there are about 28 logical rate combinations offering unique QoS in terms of Rate, BER and latency*

## High Band Symbol Rates and Link Budget

Txpow=-6.9 dBm; Coded Eb/No=9.6 dB, 3 dB implementation loss, 0 dB RAKE gain, NF=5.1 dB, 1/2 rate code gain: 5.2 dB, 2/3 rate code gain: 4.7 dB, 3/4 rate code gain: 4 dB, RS code gain: 3 dB, concatenated gain: 6.3 dB, 8-BOK coding gain: 1.4 dB, 16-BOK coding gain: 2.4 dB, 2-BOK PSD Backoff: 2.2 dB, 4-BOK PSD Backoff: 2.1 dB, 8-BOK PSD Backoff: 1.7 dB, 16-BOK PSD Backoff: 1.3 dB

Rate	Modulation	CDMA Code Type	FEC	Fc GHz	Range AWGN	Acquisition Range	4 meter margin	RX Sensitivity
100 Mbps	BPSK	4-BOK (2 bits/symbol)	Concatenated	8.1	14.2 meters	10.7 meters	11.0 dB	-82.6 dBm
114Mbps	BPSK	4-BOK (2 bits/symbol)	1/2 rate convolutional	8.1	11.7 meters	10.7 meters	9.3 dB	-80.9 dBm
200 Mbps (199.4 Mbps)	BPSK	4-BOK (2 bits/symbol)	RS(255, 223)	8.1	6.9 meters	>6.9 meters	4.7 dB	-76.3 dBm
300 Mbps (299.1 Mbps)	BPSK	8-BOK (3 bits/symbol)	RS(255, 223)	8.1	6.9 meters	>6.9 meters	4.8 dB	-75.9 dBm
400 Mbps (398.8 Mbps)	BPSK	16-BOK (4 bits/symbol)	RS(255, 223)	8.1	7.0 meters	>7.0 meters	4.9 dB	-75.7 dBm
600 Mbps (598.2 Mbps)	QPSK	8-BOK (6 bits/symbol)	RS(255, 223)	8.1	4.9 meters	>4.9 meters	1.7 dB	-72.9 dBm
800 Mbps (797.6 Mbps)	QPSK	16-BOK (8 bits/symbol)	RS(255, 223)	8.1	5.0 meters	>5.0 meters	1.9 dB	-72.7 dBm

*Table is representative - there are about 28 logical rate combinations offering unique QoS in terms of Rate, BER and latency*

- Both DFE and RAKE can improve performance
- Decision Feedback Equalizer (DFE) combats ISI, RAKE combats ICI
  - DFE or RAKE implementation is a receiver issue (beyond standard)
    - Our proposal supports either / both
    - Each is appropriate depending on the operational mode and market
  - DFE is currently used in the XSI 100 Mbps TRINITY chip set<sup>1</sup>
  - DFE with M-BOK is efficient and proven technology (ref. 802.11b CCK devices)
  - DFE Die Size Estimate: <0.1 mm<sup>2</sup>
  - DFE Error Propagation: Not a problem on 98.75% of the TG3a channels

Note 1: [http://www.xtremespectrum.com/PDF/xsi\\_trinity\\_brief.pdf](http://www.xtremespectrum.com/PDF/xsi_trinity_brief.pdf)

# CCA Performance

July 2003

doc.: IEEE 802.15-03/153r7

The following figure represents the CCA ROC curves for CM1, CM2 and CM3 at 4.1 GHz. This curve shows good performance on CM1 and CM2 with high probability of detection and low probability of false alarm (e.g. usage of a CAP CSMA based algorithm is feasible); however, on CM3 use of the management slots (slotted aloha) is probably more appropriate.

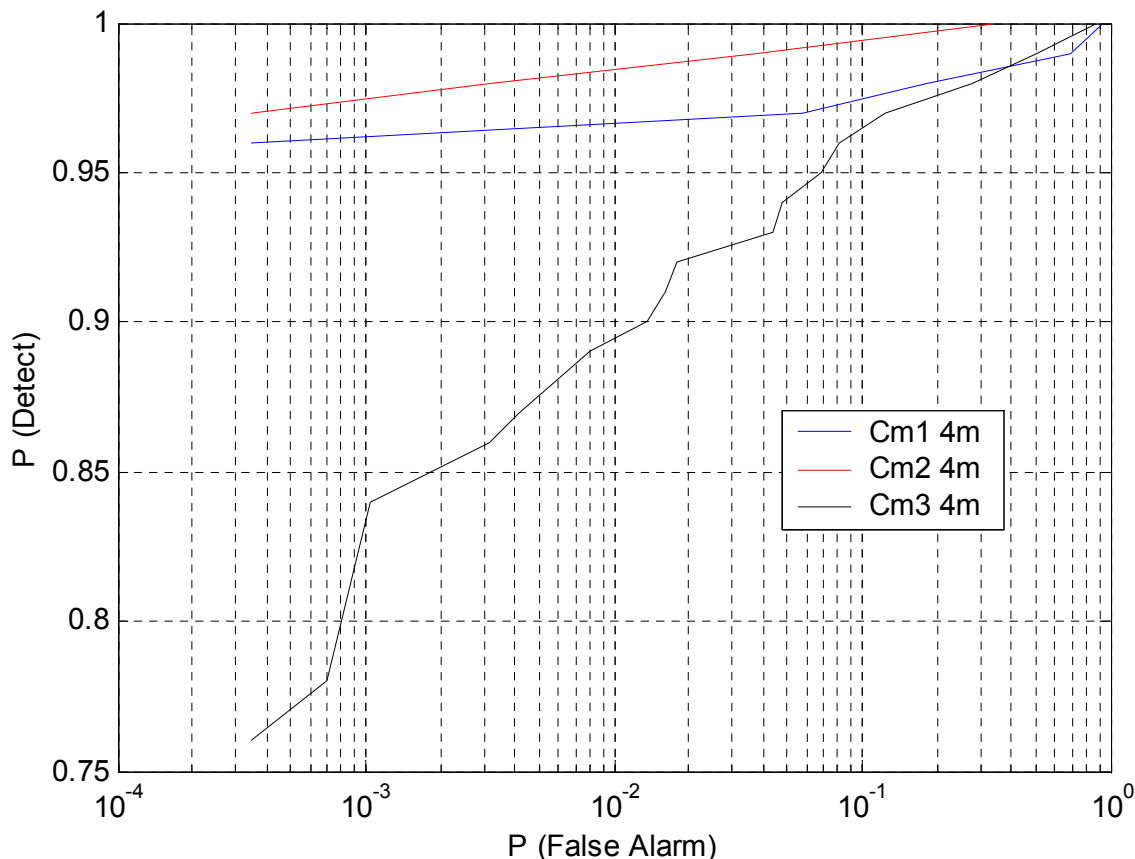

Low Band  
TX BW=1.368 GHz  
RX NF=4.2 dB  
CCA Detection BW: 200 kHz

***Our CCA scheme allows monitoring channel activity during preamble acquisition to minimize probability of false alarm acquisition attempts.***

# Multiple User Separation Distance – CM1 to CM4

July 2003

doc.: IEEE 802.15-03/153r7

*Initial Conditions:*

- *ACQ Symbol Duration=140.35 nS*
- *5 Finger RAKE*

## 114 Mbps, 8-BOK, 2/3 Rate FEC

### Averaged Outage Range

	CM1	CM2	CM3	CM4
Meters Distance	15.0	13.5	11.5	10.0

## 200 Mbps, 16-BOK, R-S FEC

### Averaged Outage Range

	CM1	CM2	CM3	CM4
Meters Distance	11.1	10.0	8.8	7.5

### Coexistence Ratios – 1 MUI

Ref \ Int	CM1	CM2	CM3	CM4
CM1	0.60	0.58	0.53	0.50
CM2	0.67	0.65	0.59	0.55
CM3	0.71	0.69	0.62	0.59
CM4	0.83	0.80	0.73	0.69

### Coexistence Ratios – 1 MUI

Ref \ Int	CM1	CM2	CM3	CM4
CM1	0.55	0.53	0.48	0.46
CM2	0.61	0.59	0.54	0.51
CM3	0.67	0.65	0.59	0.56
CM4	0.77	0.74	0.67	0.64



# Multiple User Separation Distance – CM1 to CM4

July 2003

doc.: IEEE 802.15-03/153r7

Continuing

Coexistence Ratios – 2 MUI

Ref \ Int	CM1	CM2	CM3	CM4
CM1	0.85	0.82	0.74	0.70
CM2	0.94	0.91	0.83	0.78
CM3	1.01	0.97	0.88	0.84
CM4	1.17	1.13	1.03	0.97

Coexistence Ratios – 2 MUI

Ref \ Int	CM1	CM2	CM3	CM4
CM1	0.78	0.75	0.68	0.65
CM2	0.87	0.84	0.77	0.72
CM3	0.95	0.91	0.83	0.79
CM4	1.09	1.05	0.96	0.90

Coexistence Ratios – 3 MUI

Ref \ Int	CM1	CM2	CM3	CM4
CM1	1.04	1.00	0.91	0.86
CM2	1.16	1.12	1.02	0.96
CM3	1.24	1.19	1.08	1.03
CM4	1.43	1.38	1.26	1.19

Coexistence Ratios – 3 MUI

Ref \ Int	CM1	CM2	CM3	CM4
CM1	0.96	0.92	0.84	0.79
CM2	1.06	1.03	0.94	0.88
CM3	1.16	1.12	1.02	0.96
CM4	1.33	1.28	1.17	1.11



- Three Preamble Lengths (Link Quality Dependent)
  - Short Preamble (10  $\mu$ s, short range <4 meters, high bit rate)
  - Medium Preamble (default) (15  $\mu$ s, medium range ~10 meters)
  - Long Preamble (30  $\mu$ s, long range ~20 meters, low bit rate)
  - Preamble selection done via blocks in the CTA and CTR
- PHY Header Indicates FEC type, M-BOK type and PSK type
  - Data rate is a function of FEC, M-BOK and PSK setup
  - Headers are sent with 3 dB repetition gain for reliable link establishment

# PHY Synchronization Preamble Sequence

## (low band medium length sequence<sup>1</sup>)

JNJNB5ANB6APAPCPANASASCNJNASK9B5K6B5K5D5D5B9ANASJPJNK5MNCP  
 ATB5CSJPMTK9MSJTCTASD9ASCTATASCSANCSASJSJSB5ANB6JPN5DAASB9K  
 5MSCNDE6AT3469RKWAVXM9JFEZ8CDS0D6BAV8CCS05E9ASRWR914A1BR

Notation is Base 32

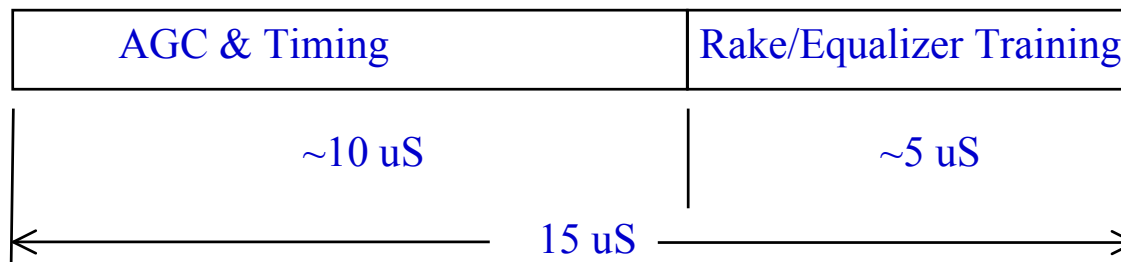

<sup>1</sup> see document 03/154r2 for sequences for the long, short and high band preambles

# Acquisition ROC Curves

July 2003

doc.: IEEE 802.15-03/153r7

Acquisition ROC curve vs. Eb/No at 114 Mbps

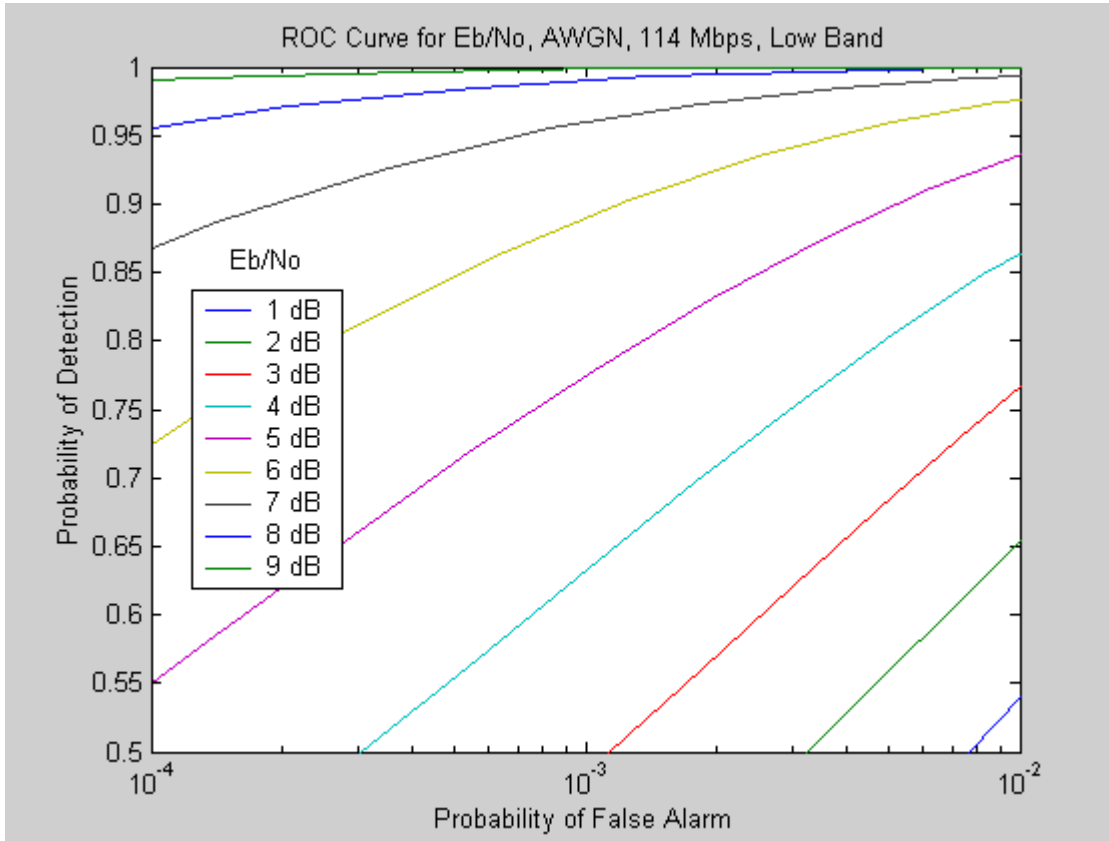

ROC Probability of detection vs. Eb/No at 114 Mbps for Pf=0.01

114 Mbps Eb/No	Pd
9 dB	1.0
8 dB	0.999
7 dB	0.994
6 dB	0.976
5 dB	0.935
4 dB	0.865
3 dB	0.770
2 dB	0.655
1 dB	0.540

*Pf: Probability of False Alarm*  
*Pd: Probability of Detection*

## Acquisition Assumptions and Comments

Timing acquisition uses a sliding correlator that searches through the multi-path components looking for the best propagating ray

Two degrees of freedom that influence the acquisition lock time (both are SNR dependent):

1. The time step of the search process
2. The number of sliding correlators

Acquisition time is a compromise between:

- acquisition hardware complexity (i.e. number of correlators)
- acquisition search step size
- acquisition SNR (i.e. range)
- acquisition reliability (i.e.  $P_d$  and  $P_f$ )

## Acquisition Assumptions and Comments (cont.)

We've limited the number of correlators during acquisition to three and we've presented results against a 15  $\mu$ S preamble length.

Naturally we could have shortened the acquisition time by increasing the acquisition hardware complexity. Our acquisition performance numbers are not absolutes but arise due to our initial assumptions.

## 1. XSI - CDMA

- The XSI CDMA codes offer some processing gain against narrowband interference (<14 dB)
- Better NBI protection is offered via tunable notch filters
  - Specification outside of the standard
- Each notch has an implementation loss <3 dB (actual loss is implementation specific)
- Each notch provides 20 to 40 dB of protection
- Uniform sampling rate facilitates the use of DSP baseband NBI rejection techniques

## 2. Comparison to Multi-band OFDM NBI Approach

- Multi-band OFDM proposes turning off a sub-band of carriers that have interference
  - RF notch filtering is still required to prevent RF front end overloading
- Turning off a sub-band impacts the TX power and causes degraded performance
- Dropping a sub-band requires either one of the following:
  - FEC across the sub-bands
    - Can significantly degrade FEC performance
  - Handshaking between TX and RX to re-order the sub-band bit loading
    - Less degradation but more complicated at the MAC sublayer

All rates in Mbps, times in $\mu$ s							
PHY Header bits	24						
MAC Header Bits	80						
HCS bits	16						
Header Bits	120						
Payload Bytes	1024						
Payload Bits	8192						
FCS Bits	32						
FEC Overhead symbols (conv)	730						
FEC Overhead symbols (RS)	3112						
Symbol Rate	57						
Header equivalent "FEC" rate	0.333333						
Header BOK bits per symbol	1						
Initial PHY Header rate	19						
FEC		conv	conv	concat	conv	R/S	R/S
Bit Rate		28.5	57	75	114	200	400
FEC symbol rate		57	114	171.5247	228	228.6996	457.3991
BOK		2	3	8	16	16	16
BPSK/QPSK		BPSK	BPSK	BPSK	BPSK	BPSK	QPSK
Bits per symbol		1	2	3	4	4	8
Payload FEC rate		0.5	0.5	0.437255	0.5	0.87451	0.87451
T_PA_INITIAL	15						
T_PA_CONT	0						
T_PHYHDR_INITIAL	1.263158						
T_MACHDR_INITIAL	4.210526						
T_HCS_INITIAL	0.842105						
T_PHYHDR_CONT		0.842105	0.421053	0.32	0.210526	0.12	0.06
T_MACHDR_CONT		2.807018	1.403509	1.066667	0.701754	0.4	0.2
T_HCS_CONT		0.561404	0.280702	0.213333	0.140351	0.08	0.04
T_MPDU		287.4386	143.7193	109.2267	71.85965	40.96	20.48
T_FCS		1.122807	0.561404	0.426667	0.280702	0.16	0.08
T_SIFS	5	5	5	5	5	5	5
T_FEC_OH		12.80702	6.403509	22.39911	3.201754	13.60737	6.803686
T_MIFS	0	0	0	0	0	0	0
T_ONE_FRAME		327.6842	177	158.3682	101.6579	81.04316	53.67948
Throughput_1		24.99968	46.28249	51.72755	80.584	101.0819	152.6095
T_FIVE_FRAMES		1498.772	762.5439	603.3816	394.4298	247.9232	137.1195
Throughput_5		27.32904	53.71494	67.88408	103.8461	165.2125	298.7176

Low Band Results,  
See 03154r3 for High Band Results

We've limited the number of correlators during acquisition to three. These results are for a 15  $\mu$ s preamble length.



## **No significant MAC or superframe modifications required!**

- From MAC point of view, 8 available logical channels
- Band switching done via DME writes to MLME

## **Proposal Offers MAC Enhancement Details (complete solution)**

- PHY PIB
  - RSSI, LQI, TPC and CCA
- Clause 6 Layer Management Enhancements
  - Ranging MLME Enhancements
  - Multi-band UWB Enhancements
- Clause 7 MAC Frame Formats
  - Ranging Command Enhancements
  - Multi-band UWB Enhancements
- Clause 8 MAC Functional Description
  - Ranging Token Exchange MSC

Additional Information can be found in doc - 03/154r3 including XSI draft text for the standard (in the appendix of -03/154r3).

# 802.15.3a Early Merge Work

XtremeSpectrum will be cooperating with Motorola

**6.1 General Solution Criteria**

<i>CRITERIA</i>	<i>REF.</i>	<i>IMPORTANCE LEVEL</i>	<i>PROPOSER RESPONSE</i>
Unit Manufacturing Complexity (UMC)	3.1	B	+
<b><i>Signal Robustness</i></b>			
Interference And Susceptibility	3.2.2	A	+
Coexistence	3.2.3	A	+
<b><i>Technical Feasibility</i></b>			
Manufacturability	3.3.1	A	+
Time To Market	3.3.2	A	+
Regulatory Impact	3.3.3	A	+
Scalability (i.e. Payload Bit Rate/Data Throughput, Channelization – physical or coded, Complexity, Range, Frequencies of Operation, Bandwidth of Operation, Power Consumption)	3.4	A	+
Location Awareness	3.5	C	+

**6.2 PHY Protocol Criteria**

<b>CRITERIA</b>	<b>REF.</b>	<b>IMPORTANCE LEVEL</b>	<b>PROPOSER RESPONSE</b>
Size And Form Factor	5.1	B	+
<b><i>PHY-SAP Payload Bit Rate &amp; Data Throughput</i></b>			
Payload Bit Rate	5.2.1	A	+
Packet Overhead	5.2.2	A	+
PHY-SAP Throughput	5.2.3	A	+
Simultaneously Operating Piconets	5.3	A	+
Signal Acquisition	5.4	A	+
System Performance	5.5	A	+
Link Budget	5.6	A	+
Sensitivity	5.7	A	+
Power Management Modes	5.8	B	+
Power Consumption	5.9	A	+
Antenna Practicality	5.10	B	+

### 6.3 MAC Protocol Enhancement Criteria

<i>CRITERIA</i>	<i>REF.</i>	<i>IMPORTANCE LEVEL</i>	<i>PROPOSER RESPONSE</i>
MAC Enhancements And Modifications	4.1.	C	+

# Back-up Support Slides

## Key Features Meet Application Requirements

- Multi-User (Multi-Piconet) Capable
  - Piconets are independent – my TV or PC doesn't coordinate/sync with my neighbor's
  - Every network supports full data-rate
    - Even at extended data rates
  - Allows very close adjacent piconets
    - Two apartments with antennas on opposite sides of the same wall
- Streaming Video Capable
  - High QOS, High Speed, Low Latency
  - Works In Home/Office/Warehouse RF environments -- Dense & High Multipath
- Low Complexity
  - Small Die Size, Low Parts Count – Low Cost
  - Low Power – Light-Weight Long-Life Batteries



## Key Features Meet Application Requirements

- Spectrally Efficient<sup>1</sup>
  - Meet Regulations and Coexists with others
    - Proven — 802.11a,b – Cordless & Cell Phones (.9, 2.4, 5.8 GHz) – Microwave ovens – GPS
  - Modulation results low Eb/No – Highest data-rate & range versus TX emission level.
  - Coded modulation method allows future growth
- Growth Path To Higher Data Rates With Backward Compatibility
  - Architecture allows component (FEC, each receiver channel, etc) usage to be adjusted such that incremental hardware additions result in the highest incremental SNR improvement.

Note 1: Reference doc IEEE802.15-03/211

DFE (Decision Feedback Equalization) used for LOS channels and NLOS channels (dotted red line represents theoretical performance). Results shown for High Band, Symbol Duration=1/114e6 seconds.

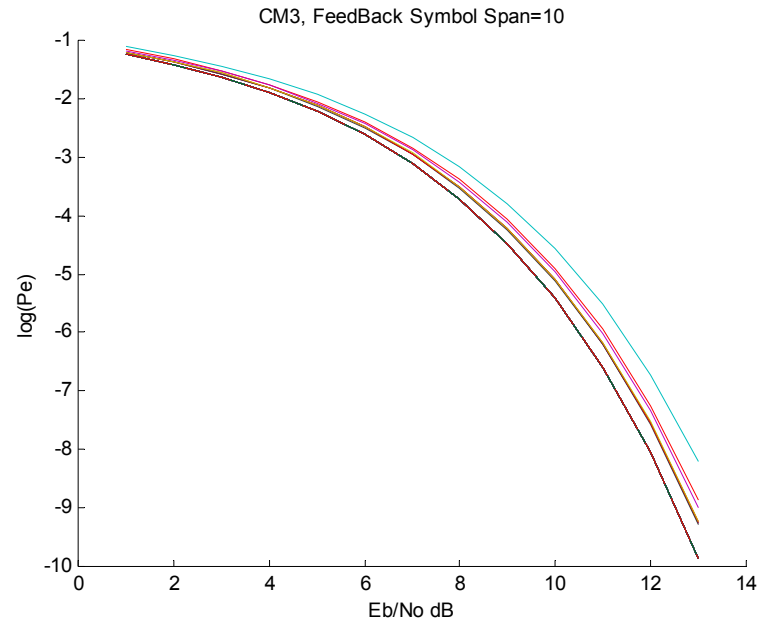
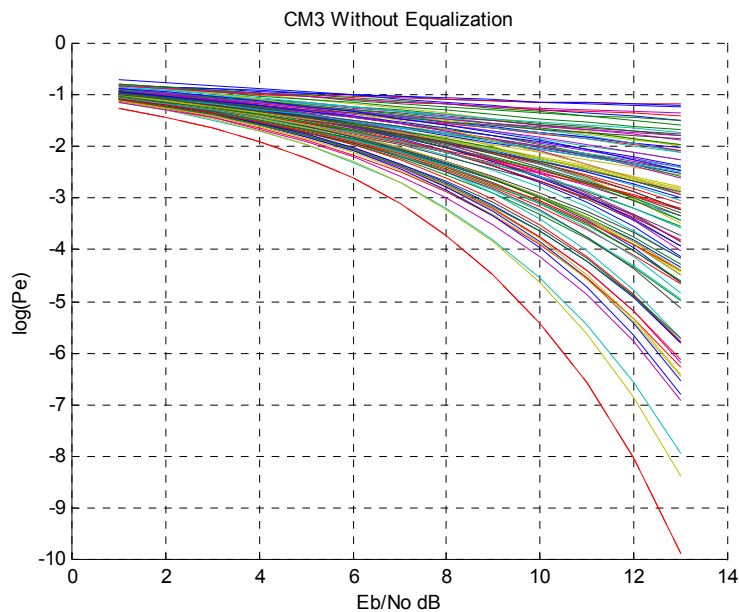

# M-BOK (M=4) Illustration

July 2003

doc.: IEEE 802.15-03/153r7

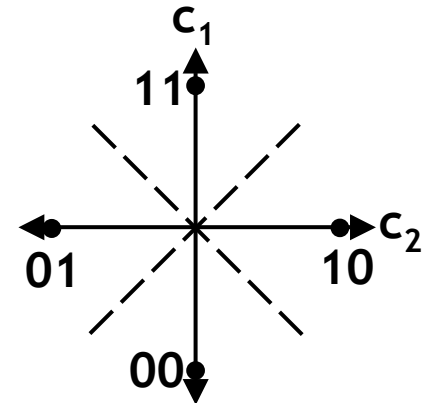
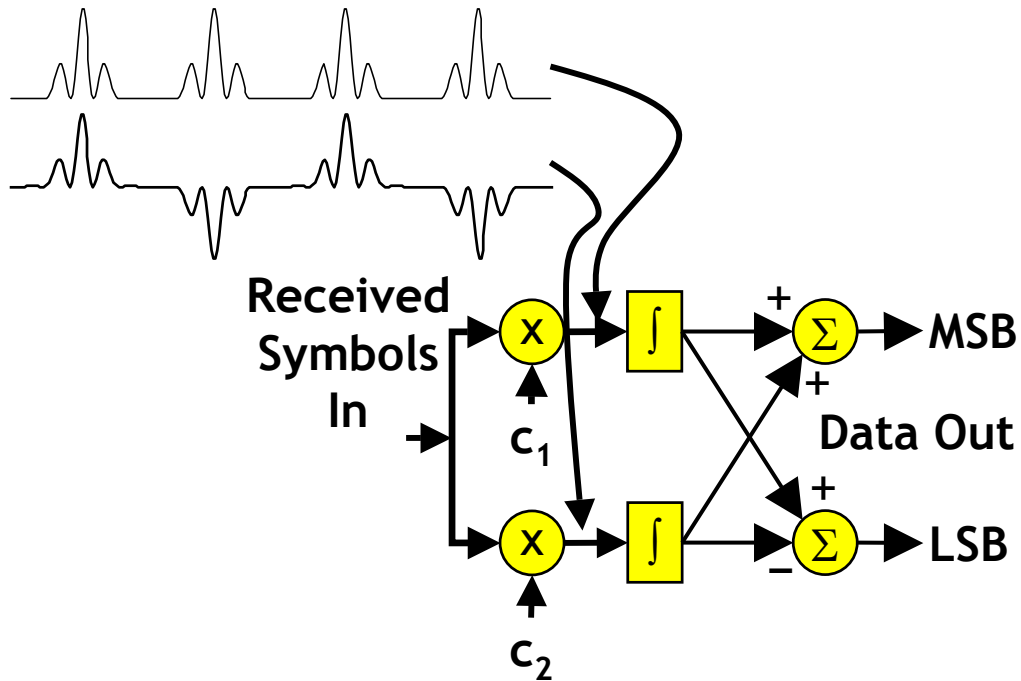
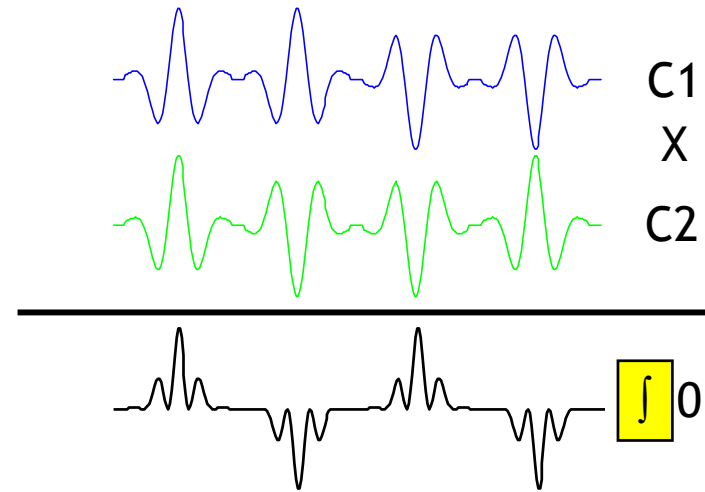
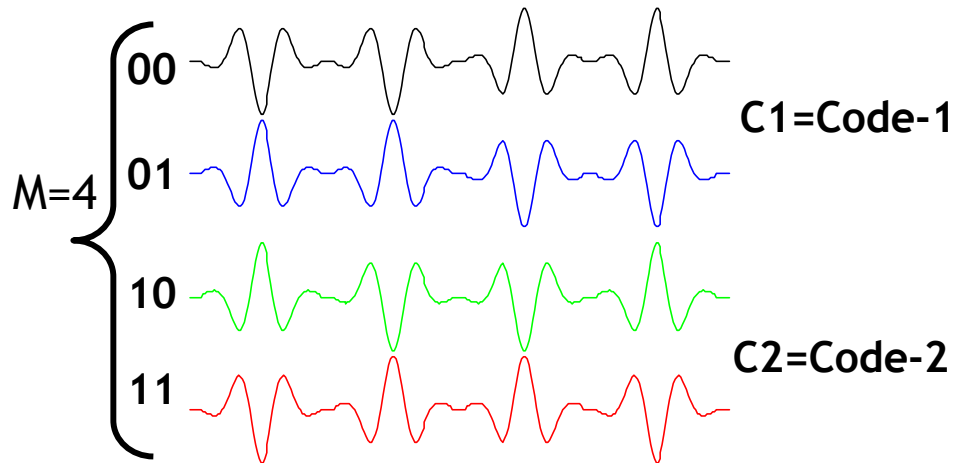

- MBOK used to carry multiple bits/symbol
- MBOK exhibits coding gain compared to QAM

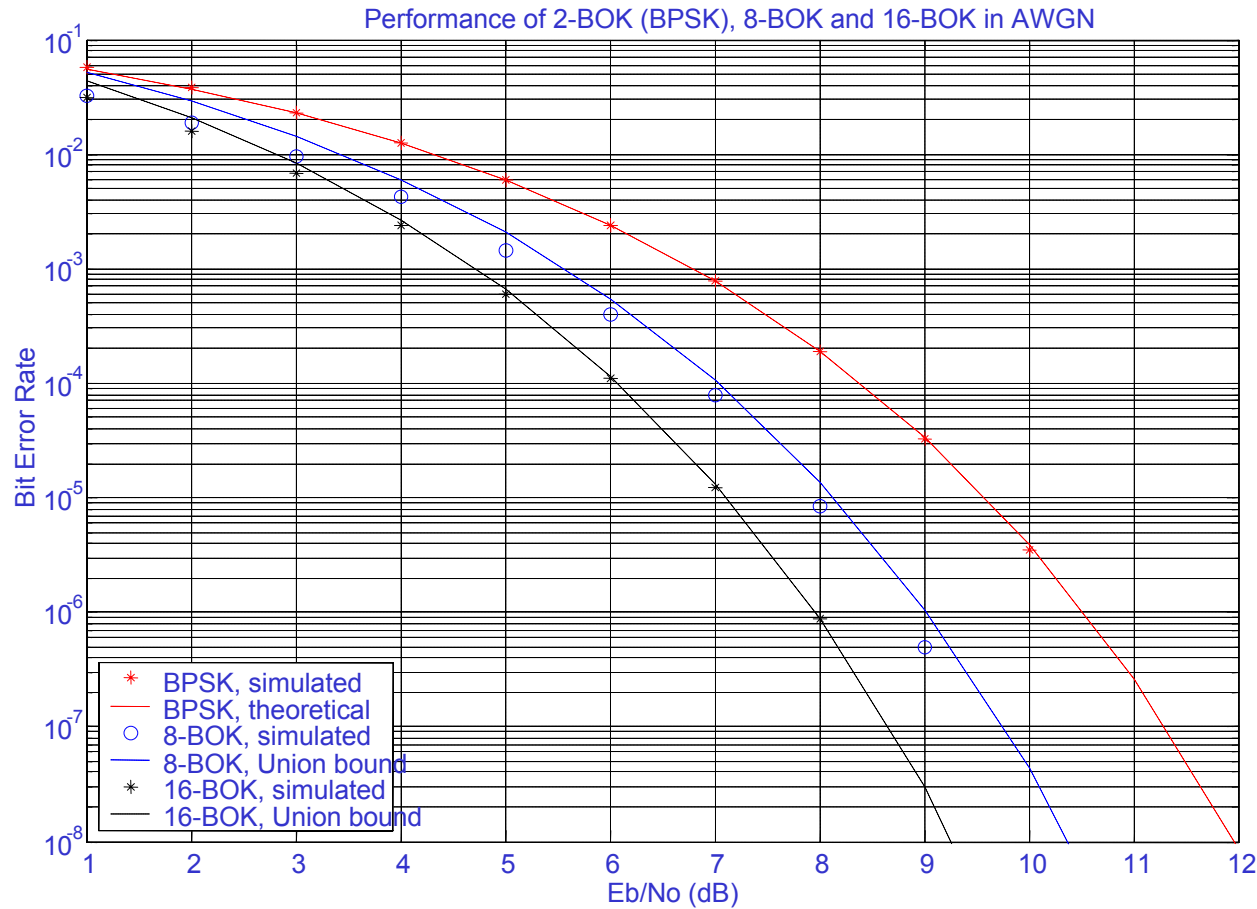

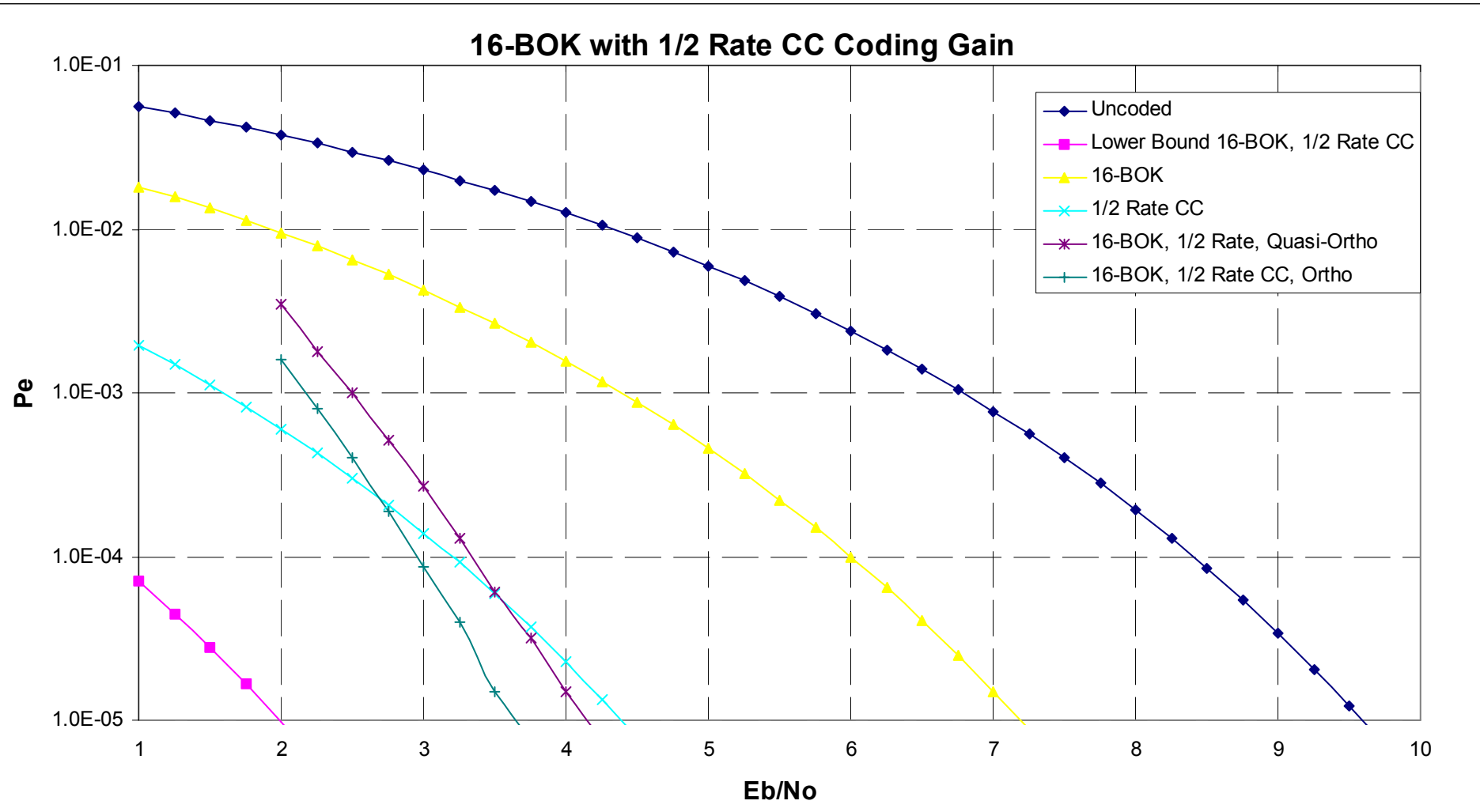

**We are falling above the lower bound ... this is due to sub-optimal soft decision mapping of the BOK symbols to bits. This is on-going work and we expect to have this resolved in the near future.**

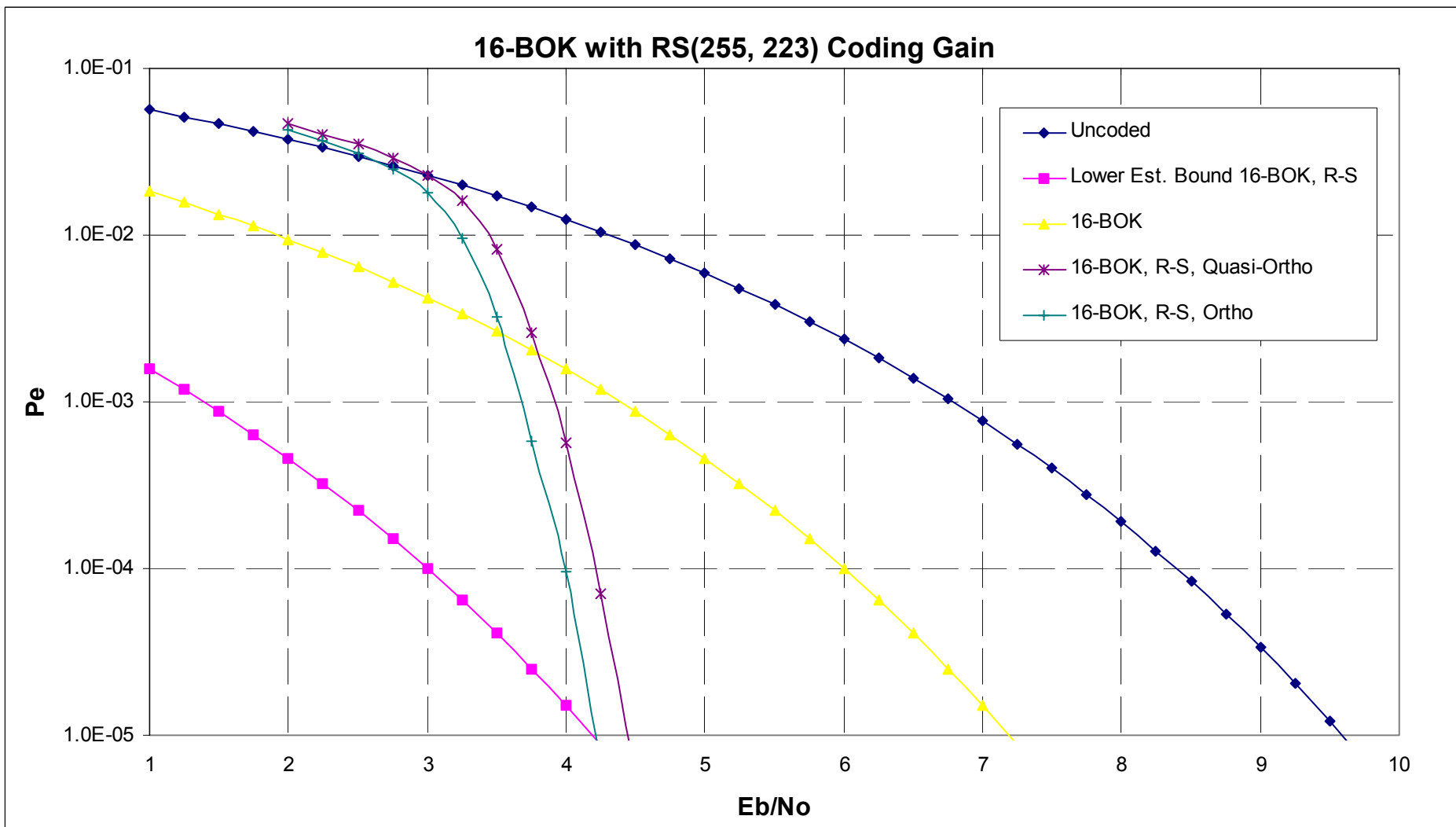

The lower bound estimate was actually done only at  $10e-5$ ; so while the lower bound is exact at  $10e-5$ , it is only an estimate above  $10e-5$ . Notice that with orthogonal codes we exactly fall on the lower bound.

# Technical Feasibility

- BPSK operation with controlled center frequency has been demonstrated in the current XSI chipset with commensurate chipping rates at 10 meters
- Current chipset uses convolutional code with Viterbi at 100 Mchip rate. We've traded-off Reed-Solomon vs. Viterbi implementation complexity and feel Reed-Solomon is suitable at higher data rates.
- Long preamble currently implemented in chipset ... have successfully simulated short & medium preambles on test channels.
- DFE implemented in the current XSI chipset at 100 Mbps. Existence proof is that IEEE802.11b uses DFE with CCK codes, which is a form of MBOK ... so it can be done economically.
- NBI filtering is currently implemented in the XSI chipset and has repeatedly been shown to work.

[http://www.xtremespectrum.com/PDF/xsi\\_trinity\\_brief.pdf](http://www.xtremespectrum.com/PDF/xsi_trinity_brief.pdf)

---

DS: direct sequence	DME: device management entity
CDMA: code division multiple access	MLME: management layer entity
PSK: phase shift keying	PIB: Personal Information Base
M-BOK: multiple bi-orthogonal keying	RSSI: received signal strength indicator
RX: receive	LQI: link quality indicator
TX: transmit	TPC: transmit power control
DFE: decision feedback equalizer	MSC: message sequence chart
PHY: physical layer	LOS: line of sight
MAC: multiple access controller	NLOS: non-line of sight
LB: low band	CCK: complementary code keying
HB: high band	ROC: receiver operating characteristics
RRC: root raised cosine filtering	Pf: Probability of False Alarm
LPF: low pass filter	Pd: Probability of Detection
FDM: frequency division multiplexing	RMS: Root-mean-square
CDM: code division multiplexing	PNC: Piconet Controller
TDM: time division multiplexing	MUI: Multiple User Interference
PNC: piconet controller	
FEC: forward error correction	
BPSK: bi-phase shift keying	
QPSK: quadri-phase shift keying	
CCA: clear channel assessment	
RS: Reed-Solomon forward error correction	
QoS: quality of service	
BER: bit error rate	
PER: packet error rate	
AWGN: additive white gaussian noise	
ISI: inter-symbol interference	
ICI: inter-chip interference	