

Project: IEEE P802.15 Working Group for Wireless Personal Area Networks (WPANs)

Submission Title: [XtremeSpectrum CFP Presentation]

Date Submitted: [March 2003]

Source: [Matt Welborn] Company [XtremeSpectrum, Inc.]

Address [8133 Leesburg Pike, Suite 700, Vienna, Va. 22182]

Voice:[703.269.3000], FAX: [703.749.0248], E-Mail:[mattw@xtremespectrum.com]

Re: [Response to Call for Proposals, document 02/372r8]

Abstract: []

Purpose: [Summary Presentation of the XtremeSpectrum proposal. Details are presented in document 03/154]

Notice: This document has been prepared to assist the IEEE P802.15. It is offered as a basis for discussion and is not binding on the contributing individual(s) or organization(s). The material in this document is subject to change in form and content after further study. The contributor(s) reserve(s) the right to add, amend or withdraw material contained herein.

Release: The contributor acknowledges and accepts that this contribution becomes the property of IEEE and may be made publicly available by P802.15.

Multi-Band DS-CDMA PSK M-BOK UWB

Table of Contents

1. Introduction
 - Spectral flexibility
 - Multiple access overview
2. System Overview
 - Scrambler and FEC coding
 - PHY preamble and header
 - Pulse shaping and modulation
 - Code sets and multiple access
3. RX link budget performance & DFE
4. PHY PIB, Layer Management and MAC Frame Formats
5. Self-Evaluation (Clause 6, Annex A of 03/031r7)

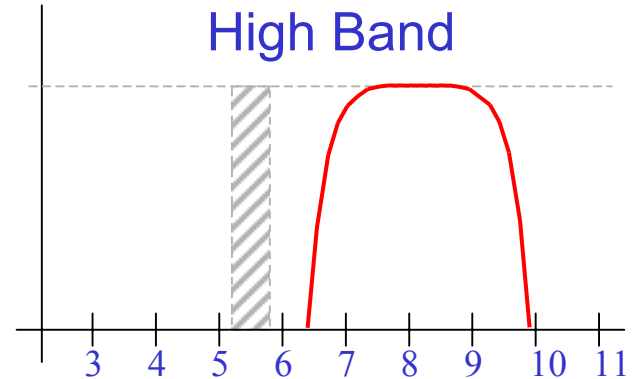
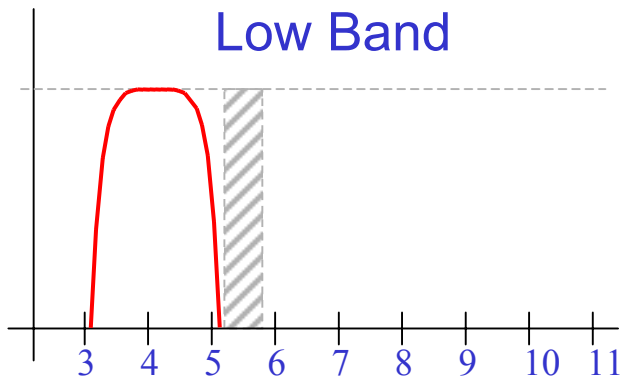

- **Low Band (3.1 to 5.15 GHz)**
 - 28.5 Mbps to 400 Mbps
 - Supports low rate, longer range services

- **High Band (5.825 to 10.6 GHz)**
 - 57 Mbps to 800 Mbps
 - Supports high rate, short range services

3 Spectral Modes of Operation

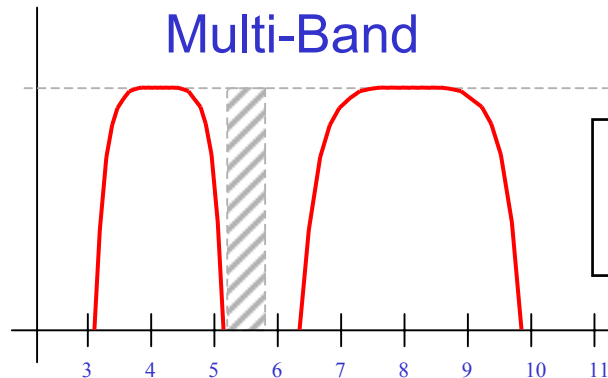

With an appropriate diplexer, the multi-band mode will support full-duplex operation (RX in one band while TX in the other)

- **Multi-Band (3.1 to 5.15 GHz plus 5.825 GHz to 10.6 GHz)**
 - Up to 1.2 Gbps
 - Gbps for short range services

- PHY Proposal accommodates alternate spectral allocations
 - Center frequency and bandwidth are adjustable
 - Maintains UWB advantages
 - **No changes to silicon**

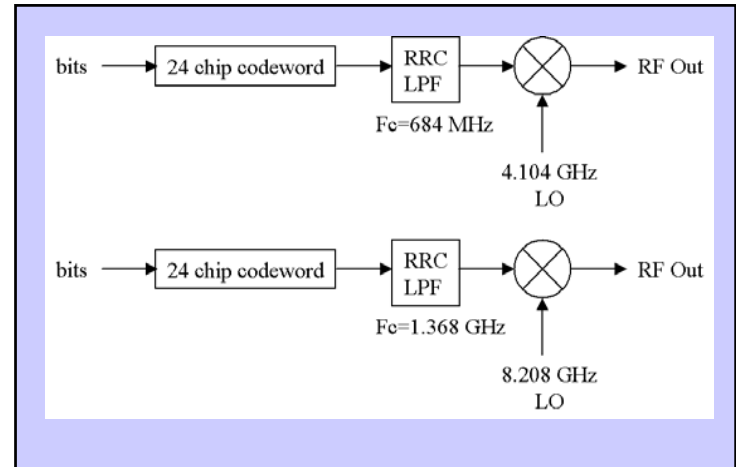

Example 1: Modified Low Band to include protection for 4.9-5.0 GHz WLAN Band

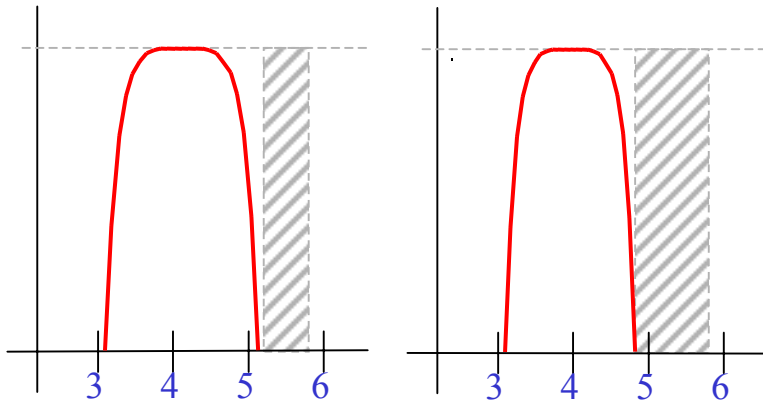

Example 2: Support for hypothetical "above 6 GHz" UWB definition

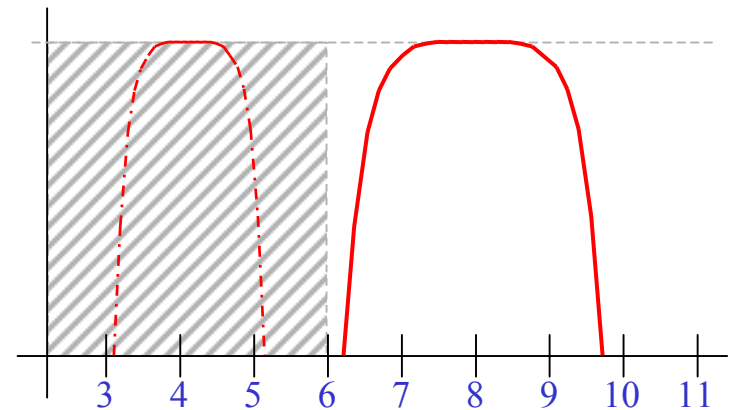

Multi-piconet capability via:

- FDM (Frequency)
 - Choice of one of two operating frequency bands
 - Alleviates severe near-far problem
- CDM (Code)
 - 4 CDMA code sets available within each frequency band
 - Provides a selection of logical channels
- TDM (Time)
 - Within each piconet the 802.15.3 TDMA protocol is used

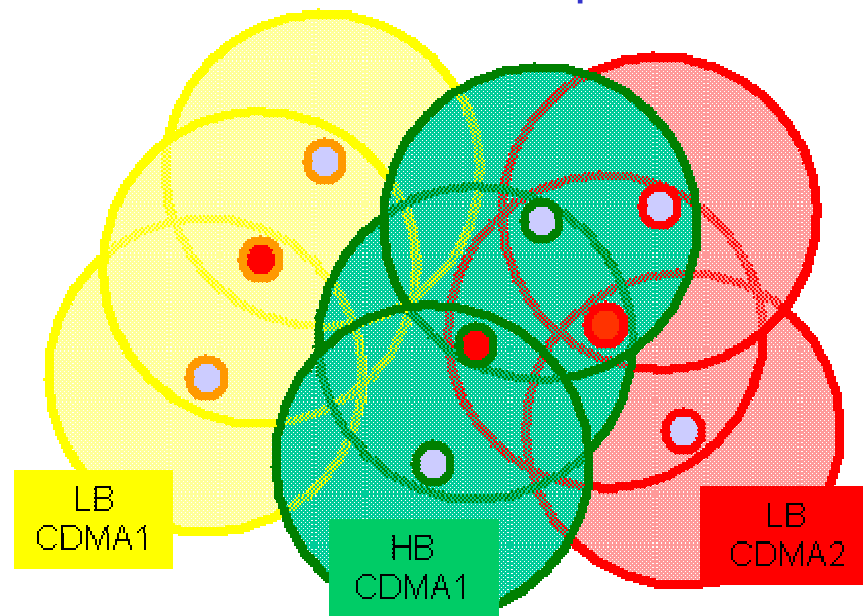
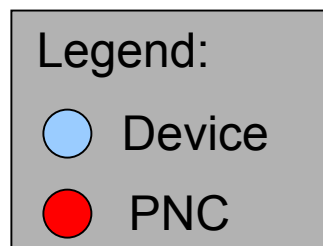

Why a Multi-Band CDMA PSK Approach?

- Support simultaneous high-rate piconets
- Low cost, low power
- Uses existing 802.15.3 MAC
 - No PHY layer protocol required
- Time to market
 - Silicon in 2003

This PHY proposal is based upon proven and common communication techniques

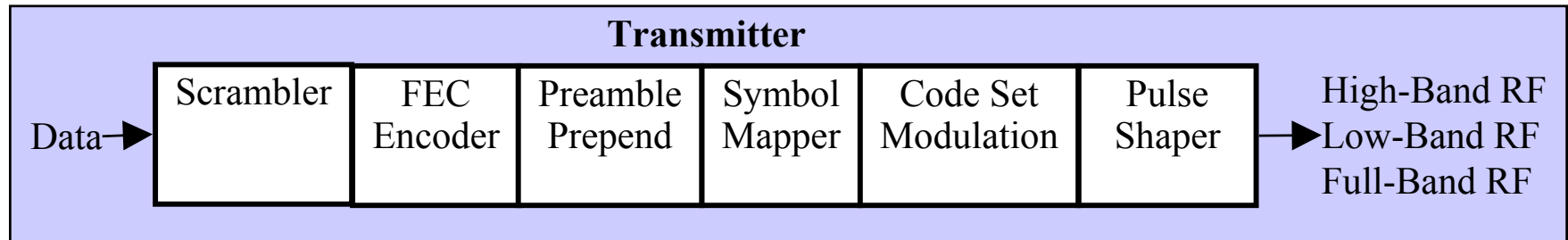

- **Multiple bits/symbol via MBOK coding**
- **Data rates from 28.5 Mbps to 1200 Mbps**
- **Multiple access via ternary CDMA coding**
- **Support for CCA by exploiting higher order properties of BPSK/QPSK**
- **Operation with up to 8 simultaneous piconets**

- Scrambler (15.3 scrambler)
 - Seed passed as part of PHY header

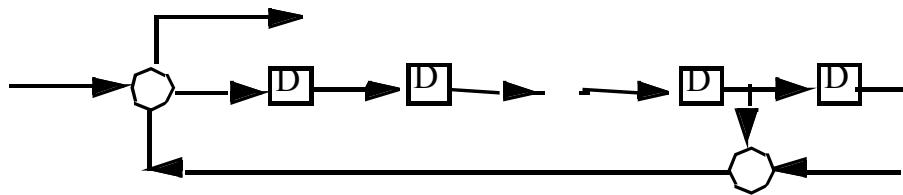

$$g(D) = 1 + D^{14} + D^{15}$$

- Forward error correction options
 - Convolutional FEC code (<200 Mbps – circ. 2002)
 - $\frac{1}{2}$ rate $K=6$, (65, 57) with $\frac{2}{3}$ and $\frac{3}{4}$ rate puncturing
 - Convolutional interleaver
 - Reed-Solomon FEC code (high rates)
 - RS(255, 223) with byte convolutional interleaver
 - Concatenated FEC code (<200 Mbps – circ. 2002)



- Three Preamble Lengths (QoS Dependent)
 - Short Preamble (10 μ s, short range <4 meters, high bit rate)
 - Medium Preamble (default) (15 μ s, medium range ~10 meters)
 - Long Preamble (30 μ s, long range ~20 meters, low bit rate)
 - Preamble selection done via blocks in the CTA and CTR
- PHY Header Indicates FEC type, M-BOK type and PSK type
 - Data rate is a function of FEC, M-BOK and PSK setup
 - Headers are sent with 3 dB repetition gain for reliable link establishment
- Acquisition PER within 0.6 dB of steady state BER RX sensitivity
 - Acquisition SNR only 0.6 dB above BER 10e-5 to achieve 8% PER with 1024 octets

- Approach uses tested direct-sequence spread spectrum techniques
- Pulse filtering/shaping used with BPSK/QPSK modulation
 - 50% excess bandwidth, root-raised-cosine impulse response
- Harmonically related chipping rate, center frequency and symbol rate
 - Reference frequency is 684 MHz

	RRC BW	Chip Rate	Code Length	Symbol Rate
Low Band	1.368 GHz	1.368 GHz (± 1 MHz, ± 3 MHz)	24 chips/symbol	57 Ms/s
High Band	2.736 GHz	2.736 GHz (± 1 MHz, ± 3 MHz)	24 chips/symbol	114 Ms/s

- CDMA via low cross-correlation *ternary* code sets ($\pm 1, 0$)
- Four logical piconets per sub-band (8 logical channels over 2 bands)
- Up to 16-BOK per piconet (4 bits/symbol bi-phase, 8 bits/symbol quad-phase)
 - 1 sign bit and 3 bit code selection per modulation dimension
 - 8 codewords per piconet
- Total number of 24-chip codewords (each band): $4 \times 8 = 32$
 - RMS cross-correlation < -15 dB in a flat fading channel
- CCA via higher order techniques
 - Squaring circuit for BPSK, fourth-power circuit for QPSK
 - Operating frequency detection via collapsing to a spectral line
- Each piconet uses a unique center frequency offset
 - Four selectable offset frequencies, one for each piconet
 - +/- 3 MHz offset, +/- 9 MHz offset

- RX Link Budget (more detail in rate-range slides)
 - 114 Mbps @ 22.4 meters (Low Band in AWGN)
 - 7.0 dB margin at 10 meters
 - RX Sensitivity of -80.9 dBm @ 4.2 dB noise figure
 - 200 Mbps @ 18.1 meters (Low Band in AWGN)
 - 5.1 dB margin at 10 meters
 - 13.0 dB margin at 4 meters
 - RX Sensitivity of -79.1 dBm @ 4.2 dB noise figure
 - 600 Mbps @ 5.8 meters (High Band in AWGN)
 - 3.3 dB margin at 4 meters
 - RX Sensitivity of -72.4 dBm @ 5.1 dB noise figure
- Decision Feedback Equalizer (DFE) to combat ISI, rake to combat ICI
 - DFE is currently used in the XSI 100 Mbps trinity chip set
 - DFE with M-BOK is efficient and proven technology (ref. 802.11b CCK devices)
 - DFE Die Size Estimate: <0.5 sq mil
 - DFE Error Propagation: Not a problem on 98.75% of the TG3a channels

Noise Figure Budget

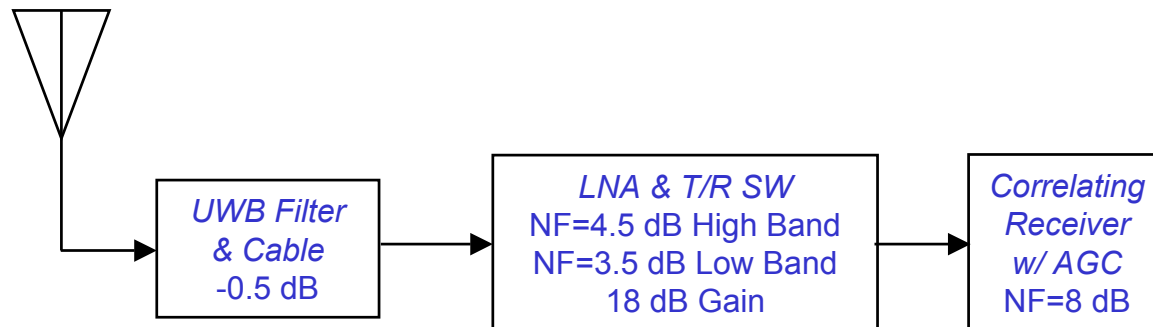

Cascaded Noise Figure

- High Band: 5.1 dB
- Low Band: 4.2 dB

Low Band Symbol Rates and Link Budget

Eb/No=9.6 dB, 3 dB implementation loss, 0 dB RAKE gain, NF=4.2 dB
 1/2 rate code gain: 5.2 dB, 2/3 rate code gain: 4.7 dB, RS code gain: 3 dB
 8-BOK coding gain: 1.4 dB, 16-BOK coding gain: 2.4 dB

Rate	Modulation	CDMA Code Type	FEC	Fc GHz ¹	Range AWGN	10 meter margin	RX Sensitivity ²
28.5 Mbps	BPSK	2-BOK (1 bits/symbol)	1/2 rate convolutional	4.0	35.1 meters	10.9 dB	-84.8 dBm
57 Mbps	BPSK	4-BOK (2 bits/symbol)	1/2 rate convolutional	4.0	24.8 meters	7.9 dB	-81.8 dBm
75 Mbps	BPSK	8-BOK (3 bits/symbol)	Concatenated	4.0	27.0 meters	8.6 dB	-82.6 dBm
114 Mbps	BPSK	8-BOK (3 bits/symbol)	2/3 rate convolutional	4.0	22.4 meters	7.0 dB	-80.9 dBm
200 Mbps (199.4 Mbps)	BPSK	16-BOK (4 bits/symbol)	RS(255, 223)	4.0	18.1 meters	5.1 dB	-79.1 dBm
400 Mbps (398.8 Mbps)	QPSK	16-BOK (8 bits/symbol)	RS(255, 223)	4.0	12.8 meters	2.1 dB	-76.1 dBm

¹ Center frequency determined as geometric mean in accordance with 03/031r7, clause 5.6

² Based upon corrected Eb/No of 9.6 dB after application of all coding gain

Coding Gain References:

- <http://www.intel.com/design/digital/STEL-2060/index.htm>
- http://grouper.ieee.org/groups/802/16/tg1/phy/contrib/802161pc-00_33.pdf

Table is representative - there are about 22 logical rate combinations offering unique QoS in terms of Rate, BER and latency

High Band Symbol Rates and Link Budget

Eb/No=9.6 dB, 3 dB implementation loss, 0 dB RAKE gain, NF=5.1 dB
 1/2 rate code gain: 5.2 dB, 2/3 rate code gain: 4.7 dB, RS code gain: 3 dB
 8-BOK coding gain: 1.4 dB, 16-BOK coding gain: 2.4 dB

Rate	Modulation	CDMA Code Type	FEC	Fc GHz	Range AWGN	4 meter margin	RX Sensitivity
100 Mbps	BPSK	4-BOK (2 bits/symbol)	Concatenated	8.1	12.6 meters	10.0 dB	-79.0 dBm
114Mbps	BPSK	4-BOK (2 bits/symbol)	1/2 rate convolutional	8.1	11.1 meters	8.8 dB	-77.9 dBm
200 Mbps (199.4 Mbps)	BPSK	4-BOK (2 bits/symbol)	RS(255, 223)	8.1	8.6 meters	6.7 dB	-75.8 dBm
300 Mbps (299.1 Mbps)	BPSK	8-BOK (3 bits/symbol)	RS(255, 223)	8.1	8.2 meters	6.3 dB	-75.4 dBm
400 Mbps (398.8 Mbps)	BPSK	16-BOK (4 bits/symbol)	RS(255, 223)	8.1	8.1 meters	6.1 dB	-75.2 dBm
600 Mbps (598.2 Mbps)	QPSK	8-BOK (4 bits/symbol)	RS(255, 223)	8.1	5.8 meters	3.3 dB	-72.4 dBm
800 Mbps (797.6 Mbps)	QPSK	16-BOK (8 bits/symbol)	RS(255, 223)	8.1	5.7 meters	3.1 dB	-72.2 dBm

Table is representative - there are about 22 logical rate combinations offering unique QoS in terms of Rate, BER and latency

No significant MAC or superframe modifications required!

- From MAC point of view, 8 available logical channels
- Band switching done via DME writes to MLME

Proposal Offers MAC Enhancement Details (complete solution)

- PHY PIB
 - RSSI, LQI, TPC and CCA
- Clause 6 Layer Management Enhancements
 - Ranging MLME Enhancements
 - Multi-band UWB Enhancements
- Clause 7 MAC Frame Formats
 - Ranging Command Enhancements
 - Multi-band UWB Enhancements
- Clause 8 MAC Functional Description
 - Ranging Token Exchange MSC

6.1 General Solution Criteria

<i>CRITERIA</i>	<i>REF.</i>	<i>IMPORTANCE LEVEL</i>	<i>PROPOSER RESPONSE</i>
Unit Manufacturing Complexity (UMC)	3.1	B	+
<i>Signal Robustness</i>			
Interference And Susceptibility	3.2.2	A	+
Coexistence	3.2.3	A	+
<i>Technical Feasibility</i>			
Manufacturability	3.3.1	A	+
Time To Market	3.3.2	A	+
Regulatory Impact	3.3.3	A	+
Scalability (i.e. Payload Bit Rate/Data Throughput, Channelization – physical or coded, Complexity, Range, Frequencies of Operation, Bandwidth of Operation, Power Consumption)	3.4	A	+
Location Awareness	3.5	C	+

6.2 PHY Protocol Criteria

CRITERIA	REF.	IMPORTANCE LEVEL	PROPOSER RESPONSE
Size And Form Factor	5.1	B	+
<i>PHY-SAP Payload Bit Rate & Data Throughput</i>			
Payload Bit Rate	5.2.1	A	+
Packet Overhead	5.2.2	A	+
PHY-SAP Throughput	5.2.3	A	+
Simultaneously Operating Piconets	5.3	A	+
Signal Acquisition	5.4	A	+
System Performance	5.5	A	+
Link Budget	5.6	A	+
Sensitivity	5.7	A	+
Power Management Modes	5.8	B	+
Power Consumption	5.9	A	+
Antenna Practicality	5.10	B	+

6.3 MAC Protocol Enhancement Criteria

<i>CRITERIA</i>	<i>REF.</i>	<i>IMPORTANCE LEVEL</i>	<i>PROPOSER RESPONSE</i>
MAC Enhancements And Modifications	4.1.	C	+

Back-up Support Slides

Key Features Meet Application Requirements

- Multi-User (Multi-Piconet) Capable
 - Piconets are independent – my TV or PC doesn't coordinate/sync with my neighbor's
 - Every network supports full data-rate
 - Even at extended data rates
 - Allows very close adjacent piconets
 - Two apartments with antennas on opposite sides of the same wall
- Streaming Video Capable
 - High QOS, High Speed, Low Latency
 - Works In Home/Office/Warehouse RF environments -- Dense & High Multipath
- Low Complexity
 - Small Die Size, Low Parts Count – Low Cost
 - Low Power – Light-Weight Long-Life Batteries

Key Features Meet Application Requirements

- Spectrally Efficient
 - Meet Regulations and Coexists with others
 - Proven — 802.11a,b – Cordless & Cell Phones (.9, 2.4, 5.8 GHz) – Microwave ovens – GPS
 - Modulation results low Eb/No – Highest data-rate & range versus TX emission level.
 - Coded modulation method allows future growth
- Growth Path To Higher Data Rates With Backward Compatibility
 - Architecture allows component (FEC, each receiver channel, etc) usage to be adjusted such that incremental hardware additions result in the highest incremental SNR improvement.

DFE (Decision Feedback Equalization) used for LOS channels and NLOS channels (dotted red line represents theoretical performance). Results shown for High Band, Symbol Duration=1/114e6 seconds.

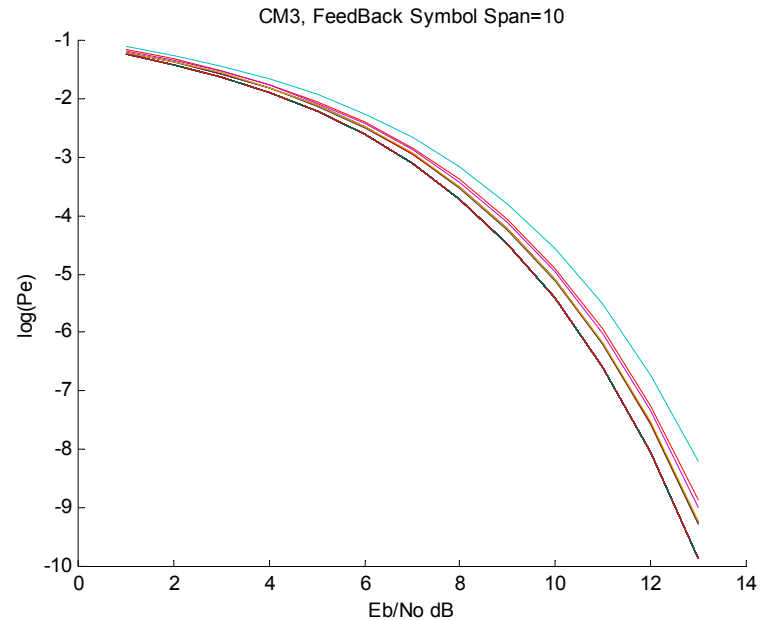
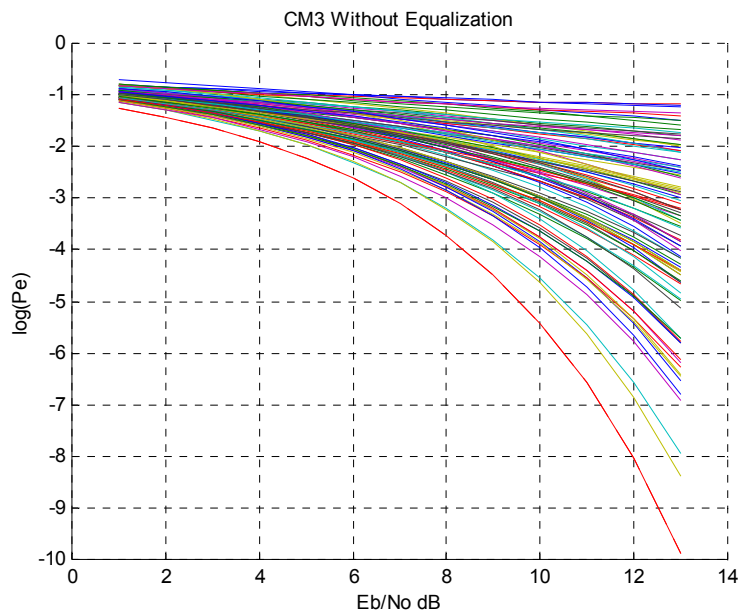

- MBOK used to carry multiple bits/symbol
- MBOK exhibits coding gain compared to QAM

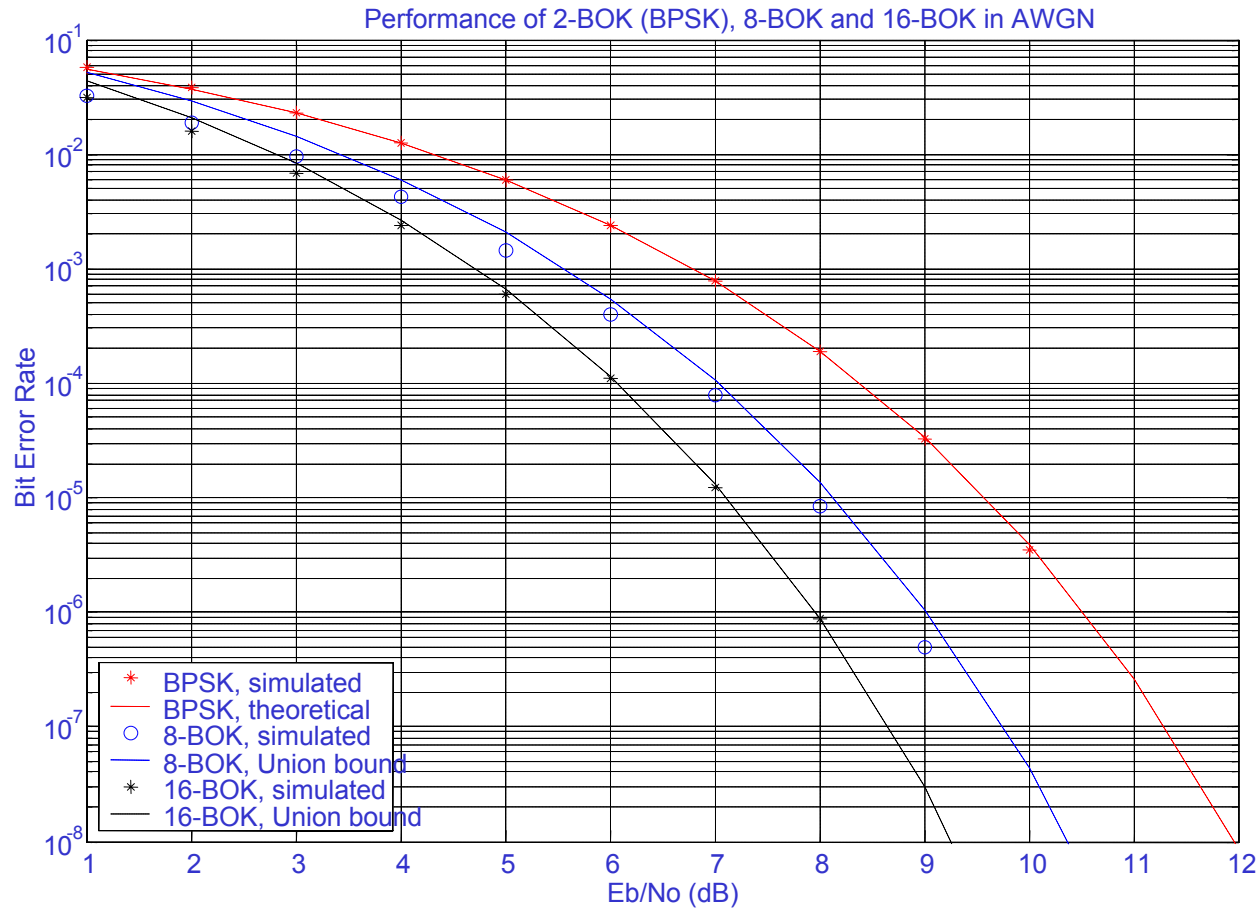

Technical Feasibility

- BPSK operation with controlled center frequency has been demonstrated in the current XSI chipset with commensurate chipping rates at 10 meters
- Current chipset uses convolutional code with Viterbi at 100 Mchip rate. We've traded-off Reed-Solomon vs. Viterbi implementation complexity and feel Reed-Solomon is suitable at higher data rates.
- Long preamble currently implemented in chipset ... have successfully simulated short & medium preambles on test channels.
- DFE implemented in the current XSI chipset at 100 Mbps. Existence proof is that IEEE802.11b uses DFE with CCK codes, which is a form of MBOK ... so it can be done economically.
- NBI filtering is currently implemented in the XSI chipset and has repeatedly been shown to work.

DS: direct sequence
CDMA: code division multiple access
PSK: phase shift keying
M-BOK: multiple bi-orthogonal keying
RX: receive
TX: transmit
DFE: decision feedback equalizer
PHY: physical layer
MAC: multiple access controller
LB: low band
HB: high band
RRC: root raised cosine filtering
LPF: low pass filter
FDM: frequency division multiplexing
CDM: code division multiplexing
TDM: time division multiplexing
PNC: piconet controller
FEC: forward error correction
BPSK: bi-phase shift keying
QPSK: quadri-phase shift keying
CCA: clear channel assessment
RS: Reed-Solomon forward error correction
QoS: quality of service
BER: bit error rate
PER: packet error rate
AWGN: additive white gaussian noise
ISI: inter-symbol interference
ICI: inter-chip interference
DME: device management entity
MLME: management layer entity
PIB: Personal Information Base
RSSI: received signal strength indicator
LQI: link quality indicator
TPC: transmit power control
MSC: message sequence chart
LOS: line of sight
NLOS: non-line of sight
CCK: complementary code keying