

Project: IEEE P802.15 Working Group for Wireless Personal Area Networks (WPANs)

Submission Title: [XtremeSpectrum CFP Presentation]

Date Submitted: [May 2003]

Source: [Matt Welborn] Company [XtremeSpectrum, Inc.]

Address [8133 Leesburg Pike, Suite 700, Vienna, Va. 22182]

Voice:[703.269.3000], FAX: [703.749.0248], E-Mail:[mwelborn@xtremespectrum.com]

Re: [Response to Call for Proposals, document 02/372r8]

Abstract: []

Purpose: [Summary Presentation of the XtremeSpectrum proposal. Details are presented in document 03/154 along with proposed draft text for the standard.]

Notice: This document has been prepared to assist the IEEE P802.15. It is offered as a basis for discussion and is not binding on the contributing individual(s) or organization(s). The material in this document is subject to change in form and content after further study. The contributor(s) reserve(s) the right to add, amend or withdraw material contained herein.

Release: The contributor acknowledges and accepts that this contribution becomes the property of IEEE and may be made publicly available by P802.15.

Multi-Band DS-CDMA PSK M-BOK UWB

Table of Contents

1. Introduction
2. System Overview
3. Code Set and Multiple Access
4. Implementation Considerations – Analog vs. Digital
5. CCA Performance
6. RX link budget performance
7. DFE and RAKE
8. Multiple User Separation Distance
9. PHY Preamble and Header
10. Acquisition ROC Curves
11. Acquisition Assumptions and Comments
12. Acquisition Distance vs. Channel Types
13. Packet Error Rate Curves (PER Curves)
14. NBI Rejection
15. Overhead and Throughput Summary
16. PHY PIB, Layer Management and MAC Frame Formats
17. Self-Evaluation (Clause 6, Annex A of 03/031r9)

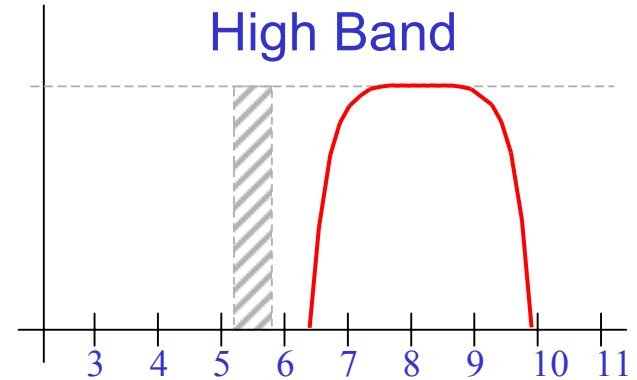
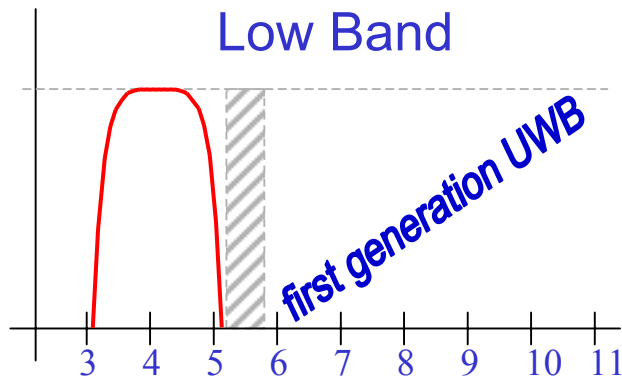

- Low Band (3.1 to 5.15 GHz)
 - 28.5 Mbps to 400 Mbps
 - Supports low rate, longer range services

- High Band (5.825 to 10.6 GHz)
 - 57 Mbps to 800 Mbps
 - Supports high rate, short range services

3 Spectral Modes of Operation

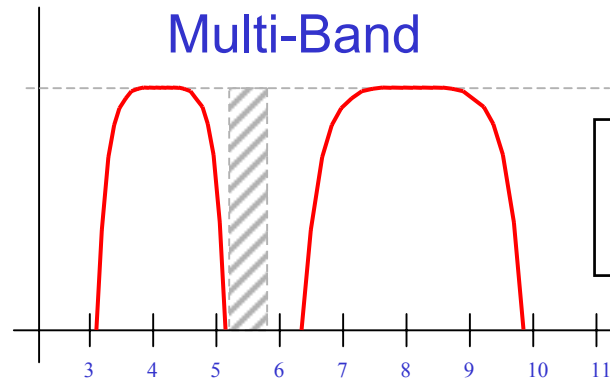

With an appropriate diplexer, the multi-band mode will support full-duplex operation (RX in one band while TX in the other)

- Multi-Band (3.1 to 5.15 GHz plus 5.825 GHz to 10.6 GHz)
 - Up to 1.2 Gbps
 - Gbps for short range services

- PHY Proposal accommodates alternate spectral allocations¹
 - Center frequency and bandwidth are adjustable
 - Supports future spectral allocations
 - Maintains UWB advantages (i.e. wide bandwidth for multipath resolution)
 - **No changes to silicon**

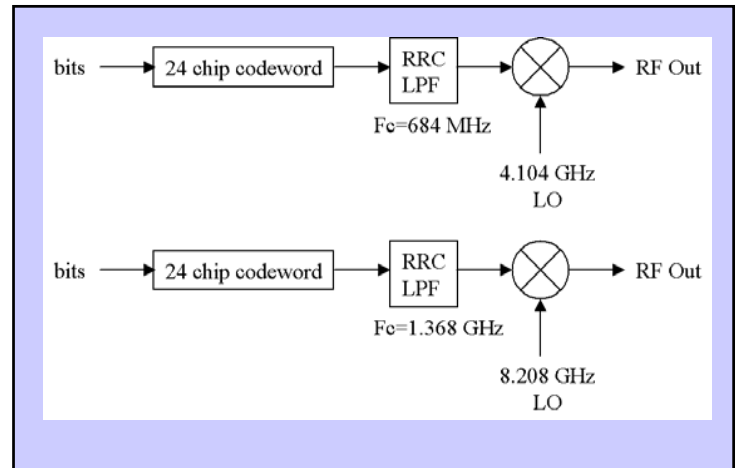

Example 2: Support for hypothetical "above 6 GHz" UWB definition

Example 1: Modified Low Band to include protection for 4.9-5.0 GHz WLAN Band

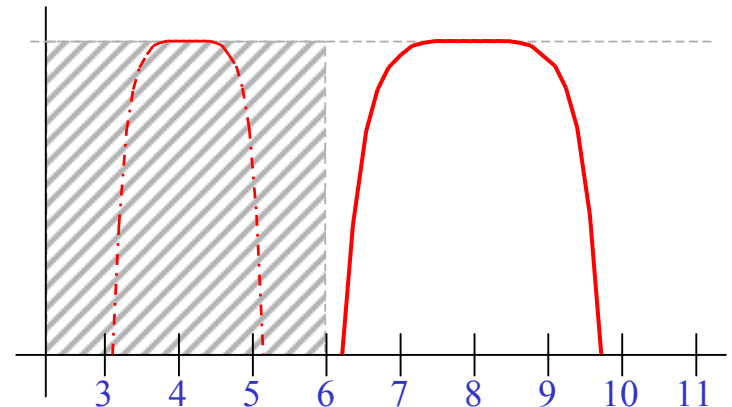
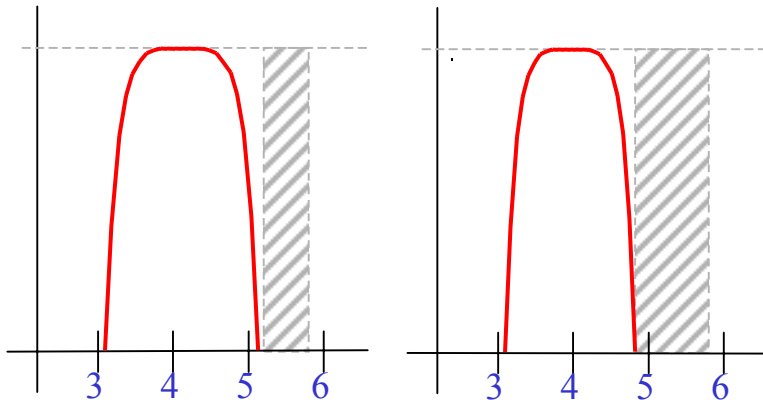

Note 1: Reference doc IEEE802.15-03/211

Multi-piconet capability via:

- FDM (Frequency)
 - Choice of one of two operating frequency bands
 - Alleviates severe near-far problem
- CDM (Code)
 - 4 CDMA code sets available within each frequency band
 - Provides a selection of logical channels
- TDM (Time)
 - Within each piconet the 802.15.3 TDMA protocol is used

Legend:	
<p>LB Ch. X</p>	<p>Low Band (FDM) Channel X (CDM) 802.15.3a piconet (TDM/TDMA)</p>
<p>HB Ch. X</p>	<p>High Band (FDM) Channel X (CDM) 802.15.3a piconet (TDM/TDMA)</p>

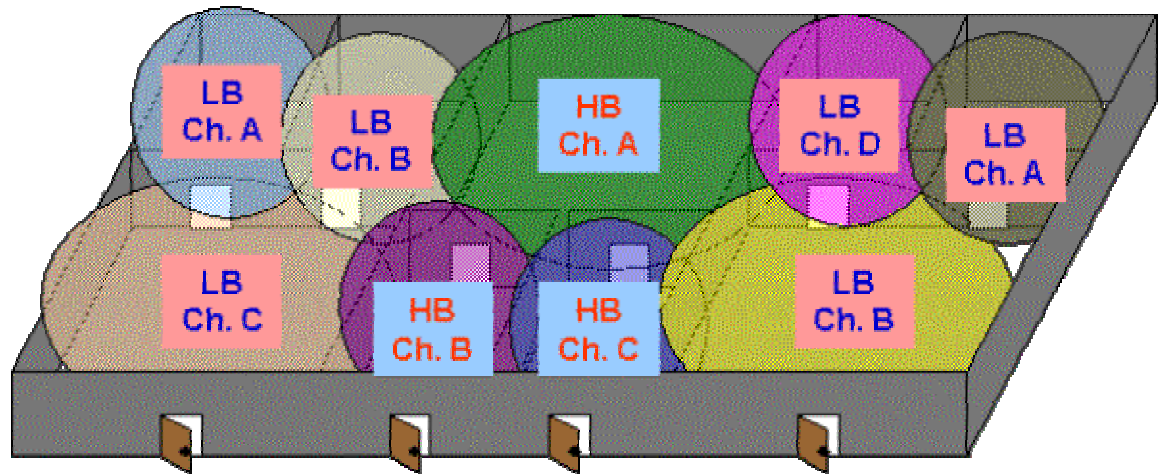

An environment depicting multiple collocated piconets

Why a Multi-Band CDMA PSK Approach?

- Support simultaneous full-rate piconets
- Low cost, low power
- Uses existing 802.15.3 MAC
 - No PHY layer protocol required
- Time to market
 - Silicon in 2003

This PHY proposal is based upon proven and common communication techniques

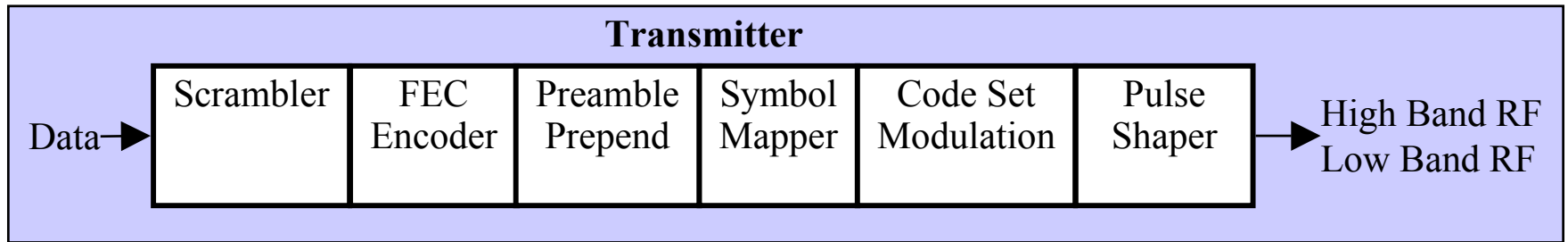

- **Multiple bits/symbol via MBOK coding**
- **Data rates from 28.5 Mbps to 1.2 Gbps**
- **Multiple access via ternary CDMA coding**
- **Support for CCA by exploiting higher order properties of BPSK/QPSK**
- **Operation with up to 8 simultaneous piconets**

- Scrambler (15.3 scrambler)
 - Seed passed as part of PHY header

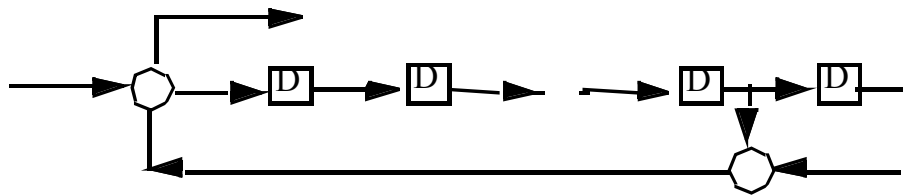

$$g(D)=1+D^{14}+D^{15}$$

- Forward error correction options
 - Convolutional FEC code (<200 Mbps – 2002 technology)
 - $\frac{1}{2}$ rate $K=7$, (171, 133) with $\frac{2}{3}$ and $\frac{3}{4}$ rate puncturing
 - Convolutional interleaver
 - Reed-Solomon FEC code (high rates)
 - RS(255, 223) with byte convolutional interleaver
 - Concatenated FEC code (<200 Mbps – 2002 technology)

- Approach uses tested direct-sequence spread spectrum techniques
- Pulse filtering/shaping used with BPSK/QPSK modulation
 - 50% excess bandwidth, root-raised-cosine impulse response
- Harmonically related chipping rate, center frequency and symbol rate
 - Reference frequency is 684 MHz

	RRC BW	Chip Rate	Code Length	Symbol Rate
Low Band	1.368 GHz	1.368 GHz (± 1 MHz, ± 3 MHz)	24 chips/symbol	57 Ms/s
High Band	2.736 GHz	2.736 GHz (± 1 MHz, ± 3 MHz)	24 chips/symbol	114 Ms/s

- CDMA via low cross-correlation *ternary* code sets ($\pm 1, 0$)
- Four logical piconets per sub-band (8 logical channels over 2 bands)
- Up to 16-BOK per piconet (4 bits/symbol bi-phase, 8 bits/symbol quad-phase)
 - 1 sign bit and 3 bit code selection per modulation dimension
 - 8 codewords per piconet
- Total number of 24-chip codewords (each band): $4 \times 8 = 32$
 - RMS cross-correlation < -15 dB in a flat fading channel
- CCA via higher order techniques
 - Squaring circuit for BPSK, fourth-power circuit for QPSK
 - Operating frequency detection via collapsing to a spectral line
- Each piconet uses a unique center frequency offset
 - Four selectable offset frequencies, one for each piconet
 - ± 3 MHz offset, ± 9 MHz offset

RX Implementation Considerations

May 2003

(Analog vs. Digital)

doc.: IEEE 802.15-03/153r5

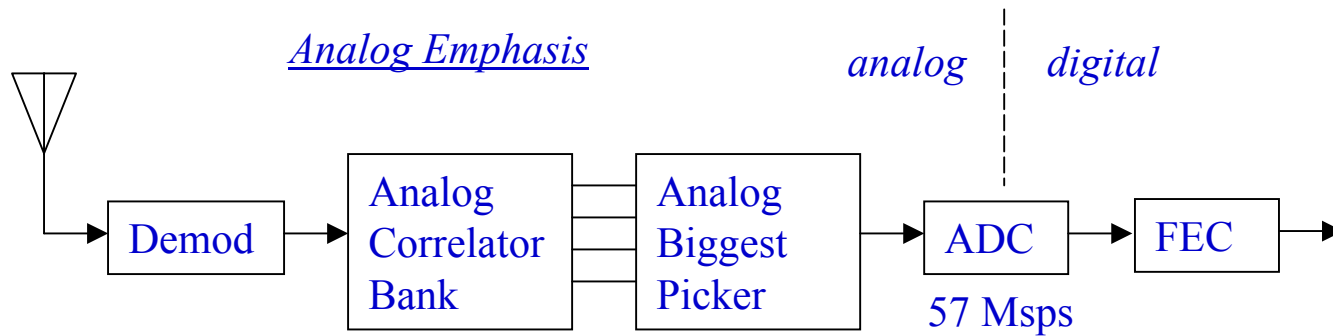

there are numerous implementation options

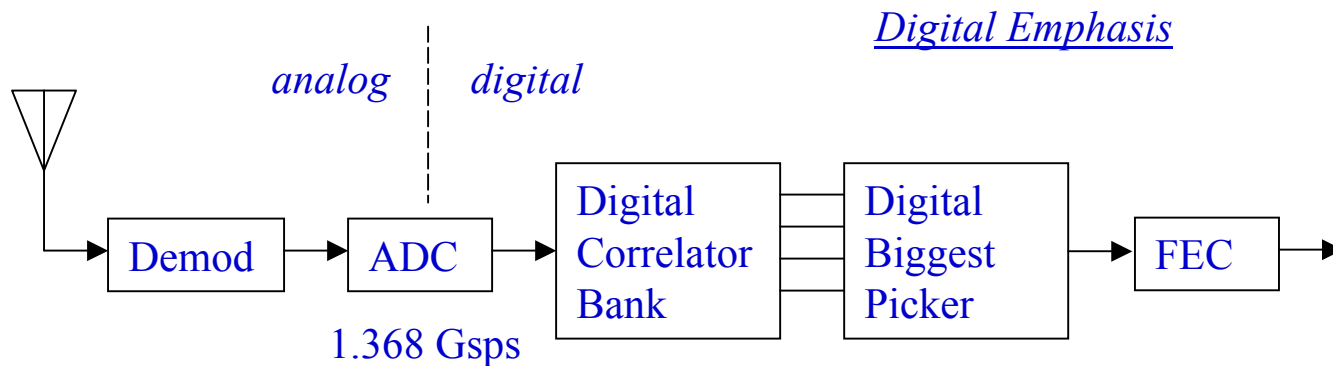

PNC1 =

-1	1	-1	-1	1	-1	-1	1	-1	0	-1	0	-1	-1	1	1	1	-1	1	1	1	-1	-1	-1
0	-1	-1	0	1	-1	-1	1	-1	-1	1	1	1	1	-1	-1	1	-1	1	-1	1	1	1	1
-1	-1	-1	-1	1	-1	1	-1	1	-1	-1	1	-1	-1	1	-1	-1	1	1	0	-1	0	1	1
0	-1	1	1	1	-1	-1	-1	-1	-1	-1	-1	1	-1	1	-1	0	1	-1	1	1	-1	-1	1
-1	0	1	-1	-1	-1	1	1	0	1	1	1	1	-1	1	-1	1	1	1	-1	1	-1	-1	1
-1	0	-1	1	-1	1	-1	-1	0	1	1	1	1	-1	1	1	-1	-1	-1	1	1	-1	1	1
-1	-1	-1	-1	-1	-1	1	1	1	0	-1	-1	1	1	-1	1	-1	1	-1	1	1	-1	0	1
-1	1	-1	-1	-1	1	-1	-1	0	-1	1	-1	-1	1	-1	0	1	1	1	1	-1	-1	-1	1

2-BOK uses code 1
 4-BOK uses codes 1 & 2
 8-BOK uses codes 1,2,3 & 4
 16-BOK uses all codes

PNC2 =

-1	-1	1	0	1	1	1	-1	-1	1	-1	1	1	-1	1	0	1	-1	-1	-1	1	-1	-1	-1
-1	-1	-1	1	-1	-1	-1	1	0	1	-1	1	1	-1	1	-1	-1	1	1	1	0	1	-1	-1
-1	1	-1	1	1	-1	1	0	1	1	1	-1	-1	1	1	-1	1	1	1	-1	-1	-1	0	-1
0	-1	1	1	1	1	-1	-1	1	1	1	-1	1	1	-1	1	1	-1	1	-1	0	-1	-1	-1
-1	1	-1	1	-1	-1	-1	-1	-1	-1	-1	1	1	1	-1	-1	1	1	-1	0	1	-1	0	1
-1	1	-1	-1	1	0	-1	-1	1	1	-1	-1	0	1	1	1	-1	-1	-1	-1	-1	1	-1	1
-1	0	1	-1	-1	-1	1	-1	1	-1	1	1	1	1	-1	-1	-1	-1	1	-1	0	1	-1	-1
-1	-1	-1	-1	-1	-1	1	1	1	0	-1	1	-1	1	-1	1	1	-1	-1	1	-1	0	1	-1

PNC3 =

-1	1	-1	1	-1	-1	0	1	-1	-1	-1	1	-1	-1	1	0	-1	-1	-1	-1	1	1	1	1
-1	-1	1	1	-1	-1	-1	-1	-1	-1	1	1	0	1	-1	1	1	-1	1	-1	0	-1	1	-1
-1	-1	-1	1	1	1	-1	-1	-1	1	-1	-1	-1	1	-1	-1	1	-1	1	0	1	1	0	1
-1	-1	1	-1	-1	1	1	1	-1	-1	1	-1	-1	-1	-1	0	1	1	-1	1	-1	1	0	1
-1	-1	-1	1	-1	1	-1	1	0	-1	-1	-1	1	1	1	1	-1	1	1	-1	0	1	-1	-1
-1	-1	-1	0	-1	-1	-1	-1	1	1	1	0	1	-1	-1	1	-1	1	-1	1	1	-1	-1	1
-1	1	-1	1	-1	1	1	0	1	1	1	0	-1	1	1	-1	1	1	-1	-1	-1	-1	1	1
-1	1	0	-1	1	-1	1	-1	-1	-1	1	-1	-1	0	1	-1	-1	1	1	1	1	-1	-1	-1

PNC4 =

-1	-1	1	1	1	-1	-1	-1	-1	-1	-1	0	-1	1	-1	1	-1	1	1	-1	1	1	-1	0
-1	-1	-1	1	-1	1	1	1	1	-1	1	1	-1	1	1	-1	-1	1	1	1	0	0	-1	1
-1	1	-1	1	1	1	1	0	-1	-1	-1	-1	1	-1	0	-1	-1	1	1	-1	-1	1	1	-1
0	-1	-1	-1	-1	-1	-1	1	1	0	-1	1	1	-1	1	-1	-1	1	1	-1	1	-1	1	-1
-1	-1	1	1	-1	-1	1	0	-1	1	1	1	1	-1	1	-1	1	-1	0	-1	1	1	1	1
-1	-1	1	-1	-1	1	-1	-1	0	-1	1	-1	1	1	-1	-1	1	-1	0	-1	1	1	1	1
-1	1	0	1	-1	-1	-1	1	1	-1	0	-1	1	-1	-1	1	-1	1	1	1	1	1	1	1
-1	-1	-1	-1	1	-1	1	0	-1	1	-1	1	1	1	0	1	-1	-1	1	1	-1	-1	1	1

	2-BOK	4-BOK	8-BOK	16-BOK
Spectral Pk-to-Avg Backoff	2.2 dB	2.1 dB	1.7 dB	1.3 dB

Worst Case Synchronized Cross-correlation Coefficient within a group	2/22
Average RMS Cross Correlation between groups	channel dependent but generally looks like $10 \cdot \log_{10}(1/24)$ noise due to center frequency offset and chipping rate frequency offset

- RX Link Budget (more detail in rate-range slides)
 - 114 Mbps @ 21.6 meters (Low Band in AWGN)
 - 6.7 dB margin at 10 meters
 - Acquisition range limited at 18.7 meters
 - RX Sensitivity of -82.7 dBm @ 4.2 dB noise figure
 - 200 Mbps @ 15.8 meters (Low Band in AWGN)
 - 4.0 dB margin at 10 meters
 - 11.9 dB margin at 4 meters
 - Not acquisition range limited
 - RX Sensitivity of -79.6 dBm @ 4.2 dB noise figure
 - 600 Mbps @ 4.9 meters (High Band in AWGN)
 - 1.7 dB margin at 4 meters
 - Not acquisition range limited
 - RX Sensitivity of -72.7 dBm @ 5.1 dB noise figure

Noise Figure Budget & Receiver Structure

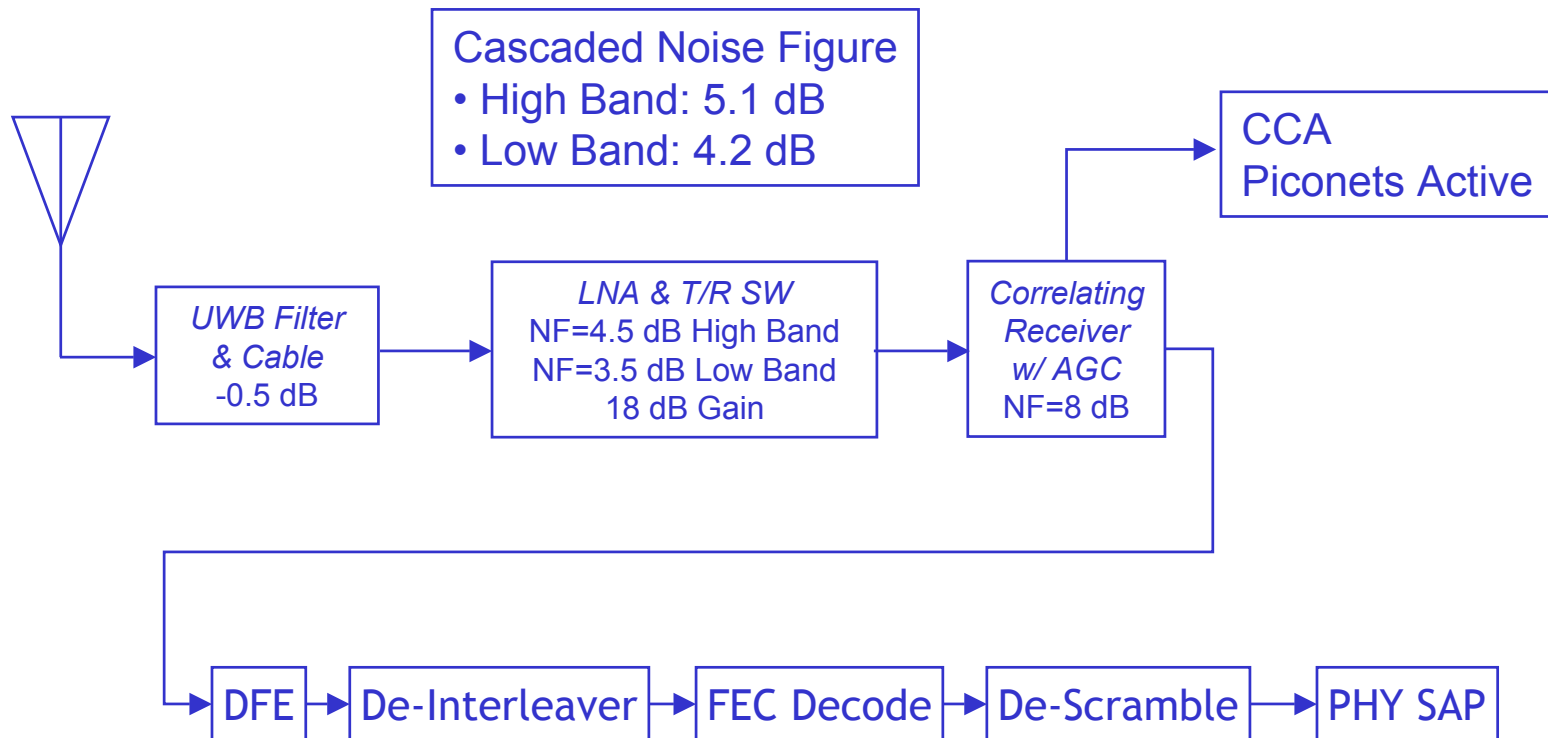

Low Band Symbol Rates and Link Budget

May 2003

doc.: IEEE 802.15-03/153r5

Txpow=-9.9 dBm; Coded Eb/No=9.6 dB, 3 dB implementation loss, 0 dB RAKE gain, NF=4.2 dB, 1/2 rate code gain: 5.2 dB, 2/3 rate code gain: 4.7 dB, 3/4 rate code gain: 4 dB, RS code gain: 3 dB, concatenated gain: 6.3 dB, 8-BOK coding gain: 1.4 dB, 16-BOK coding gain: 2.4 dB, 2-BOK PSD Backoff: 2.2 dB, 4-BOK PSD Backoff: 2.1 dB, 8-BOK PSD Backoff: 1.7 dB, 16-BOK PSD Backoff: 1.3 dB

Rate	Modulation	CDMA Code Type	FEC	Fc GHz ¹	Range AWGN	Acquisition Range	10 meter margin	RX Sensitivity ²
28.5 Mbps	BPSK	2-BOK (1 bits/symbol)	1/2 rate convolutional	4.0	36.8 meters	17.6 meters	11.3 dB	-87.9 dBm
57 Mbps	BPSK	4-BOK (2 bits/symbol)	1/2 rate convolutional	4.0	26.3 meters	17.8 meters	8.4 dB	-84.8 dBm
75 Mbps	BPSK	8-BOK (3 bits/symbol)	Concatenated	4.0	32.1 meters	18.7 meters	10.1 dB	-86.2 dBm
100 Mbps	BPSK	4-BOK (2 bits/symbol)	RS(255, 223)	4.0	15.5 meters	>15.5 meters	3.8 dB	-80.2 dBm
114 Mbps	BPSK	8-BOK (4 bits/symbol)	2/3 rate convolutional	4.0	21.6 meters	18.7 meters	6.7 dB	-82.7 dBm
200 Mbps (199.4 Mbps)	BPSK	16-BOK (4 bits/symbol)	RS(255, 223)	4.0	15.8 meters	>15.8 meters	4.0 dB	-79.6 dBm
400 Mbps (398.8 Mbps)	QPSK	16-BOK (8 bits/symbol)	RS(255, 223)	4.0	11.2 meters	>11.2 meters	1.0 dB	-76.6 dBm

¹ Center frequency determined as geometric mean in accordance with 03/031r9, clause 5.6

² Based upon corrected Eb/No of 9.6 dB after application of all coding gain

Coding Gain References:

- <http://www.intel.com/design/digital/STEL-2060/index.htm>
- http://grouper.ieee.org/groups/802/16/tg1/phy/contrib/802161pc-00_33.pdf

Table is representative - there are about 24 logical rate combinations offering unique QoS in terms of Rate, BER and latency

High Band Symbol Rates and Link Budget

Txpow=-6.9 dBm; Coded Eb/No=9.6 dB, 3 dB implementation loss, 0 dB RAKE gain, NF=5.1 dB, 1/2 rate code gain: 5.2 dB, 2/3 rate code gain: 4.7 dB, 3/4 rate code gain: 4 dB, RS code gain: 3 dB, concatenated gain: 6.3 dB, 8-BOK coding gain: 1.4 dB, 16-BOK coding gain: 2.4 dB, 2-BOK PSD Backoff: 2.2 dB, 4-BOK PSD Backoff: 2.1 dB, 8-BOK PSD Backoff: 1.7 dB, 16-BOK PSD Backoff: 1.3 dB

Rate	Modulation	CDMA Code Type	FEC	Fc GHz	Range AWGN	Acquisition Range	4 meter margin	RX Sensitivity
100 Mbps	BPSK	4-BOK (2 bits/symbol)	Concatenated	8.1	14.2 meters	11.2 meters	11.0 dB	-81.8 dBm
114Mbps	BPSK	4-BOK (2 bits/symbol)	1/2 rate convolutional	8.1	11.7 meters	11.2 meters	9.3 dB	-80.1 dBm
200 Mbps (199.4 Mbps)	BPSK	4-BOK (2 bits/symbol)	RS(255, 223)	8.1	6.9 meters	>6.9 meters	4.7 dB	-75.5 dBm
300 Mbps (299.1 Mbps)	BPSK	8-BOK (3 bits/symbol)	RS(255, 223)	8.1	6.9 meters	>6.9 meters	6.5 dB	-75.5 dBm
400 Mbps (398.8 Mbps)	BPSK	16-BOK (4 bits/symbol)	RS(255, 223)	8.1	7.0 meters	>7.0 meters	4.9 dB	-75.7 dBm
600 Mbps (598.2 Mbps)	QPSK	8-BOK (4 bits/symbol)	RS(255, 223)	8.1	4.9 meters	>4.9 meters	1.7 dB	-72.5 dBm
800 Mbps (797.6 Mbps)	QPSK	16-BOK (8 bits/symbol)	RS(255, 223)	8.1	5.0 meters	>5.0 meters	1.9 dB	-72.7 dBm

Table is representative - there are about 24 logical rate combinations offering unique QoS in terms of Rate, BER and latency

- Both DFE and RAKE can improve performance
- Decision Feedback Equalizer (DFE) combats ISI, RAKE combats ICI
 - DFE or RAKE implementation is a receiver issue (beyond standard)
 - Our proposal supports either / both
 - Each is appropriate depending on the operational mode and market
 - DFE is currently used in the XSI 100 Mbps TRINITY chip set¹
 - DFE with M-BOK is efficient and proven technology (ref. 802.11b CCK devices)
 - DFE Die Size Estimate: <0.5 sq mil
 - DFE Error Propagation: Not a problem on 98.75% of the TG3a channels

Note 1: http://www.xtremespectrum.com/PDF/xsi_trinity_brief.pdf

CCA Performance

May 2003

doc.: IEEE 802.15-03/153r5

The following figure represents the CCA ROC curves for CM1, CM2 and CM3 at 4.1 GHz. This curve shows good performance on CM1 and CM2 with high probability of detection and low probability of false alarm (e.g. usage of a CAP CSMA based algorithm is feasible); however, on CM3 use of the management slots (slotted aloha) is probably more appropriate.

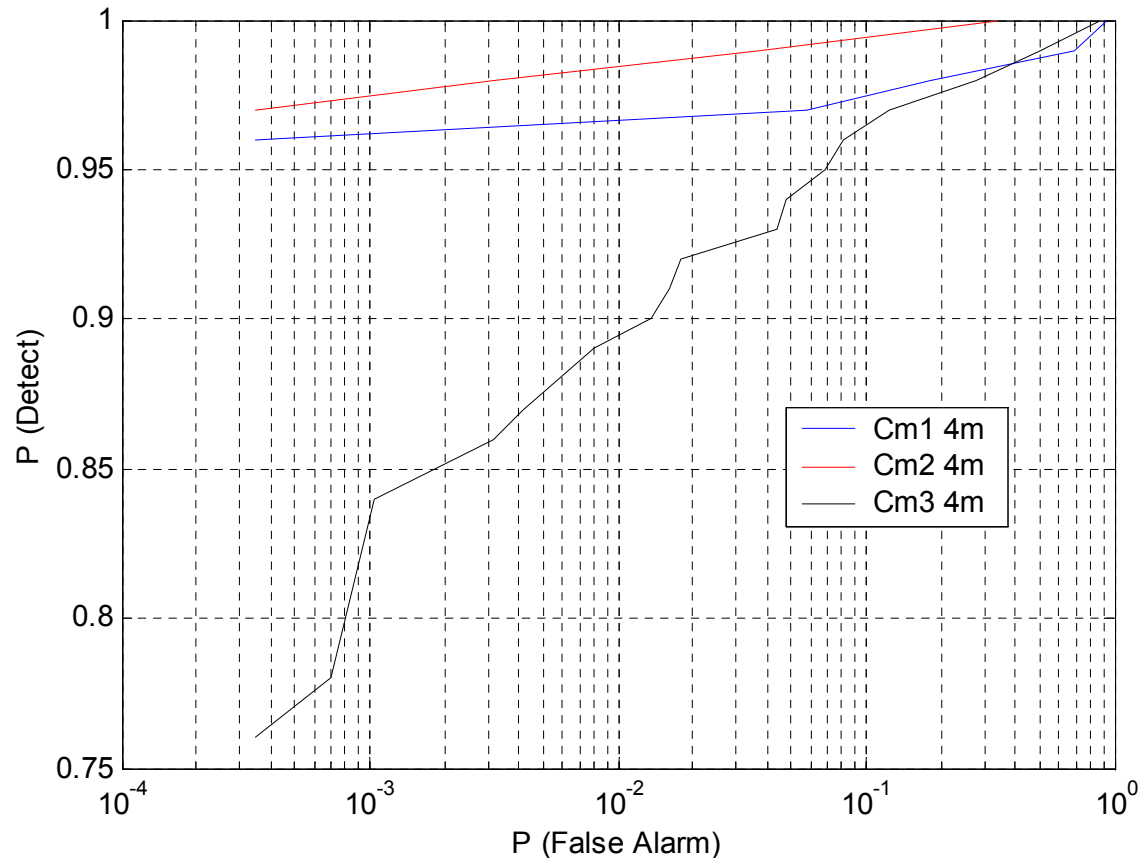

Path Loss Exponent

CM1: $r^{2.0}$ mean path

CM2: $r^{2.5}$ mean path

CM3: $r^{3.0}$ mean path

Low Band

TX BW=1.368 GHz

RX NF=4.2 dB

CCA Detection BW: 200 kHz

Our CCA scheme allows monitoring channel activity during preamble acquisition to minimize probability of false alarm acquisition attempts.

Multiple User Separation Distance

May 2003

doc.: IEEE 802.15-03/153r5

Performance in AWGN

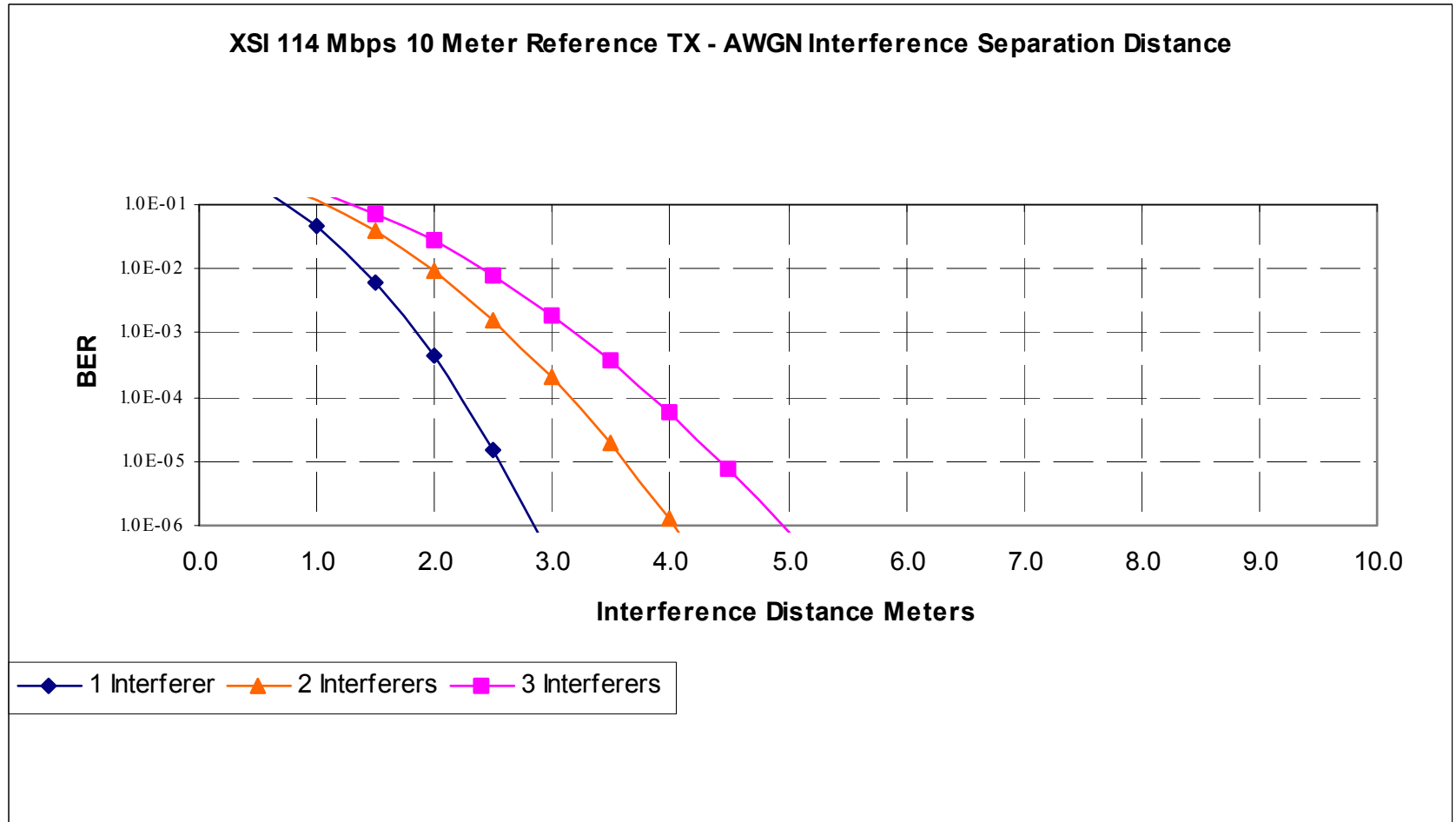

Tests are done in the Low Band, 114 Mbps, 16-BOK, $\frac{1}{2}$ rate Convolutional FEC
Reference Link Distance: 10 meters

Multiple User Separation Distance

May 2003

doc.: IEEE 802.15-03/153r5

Performance in AWGN

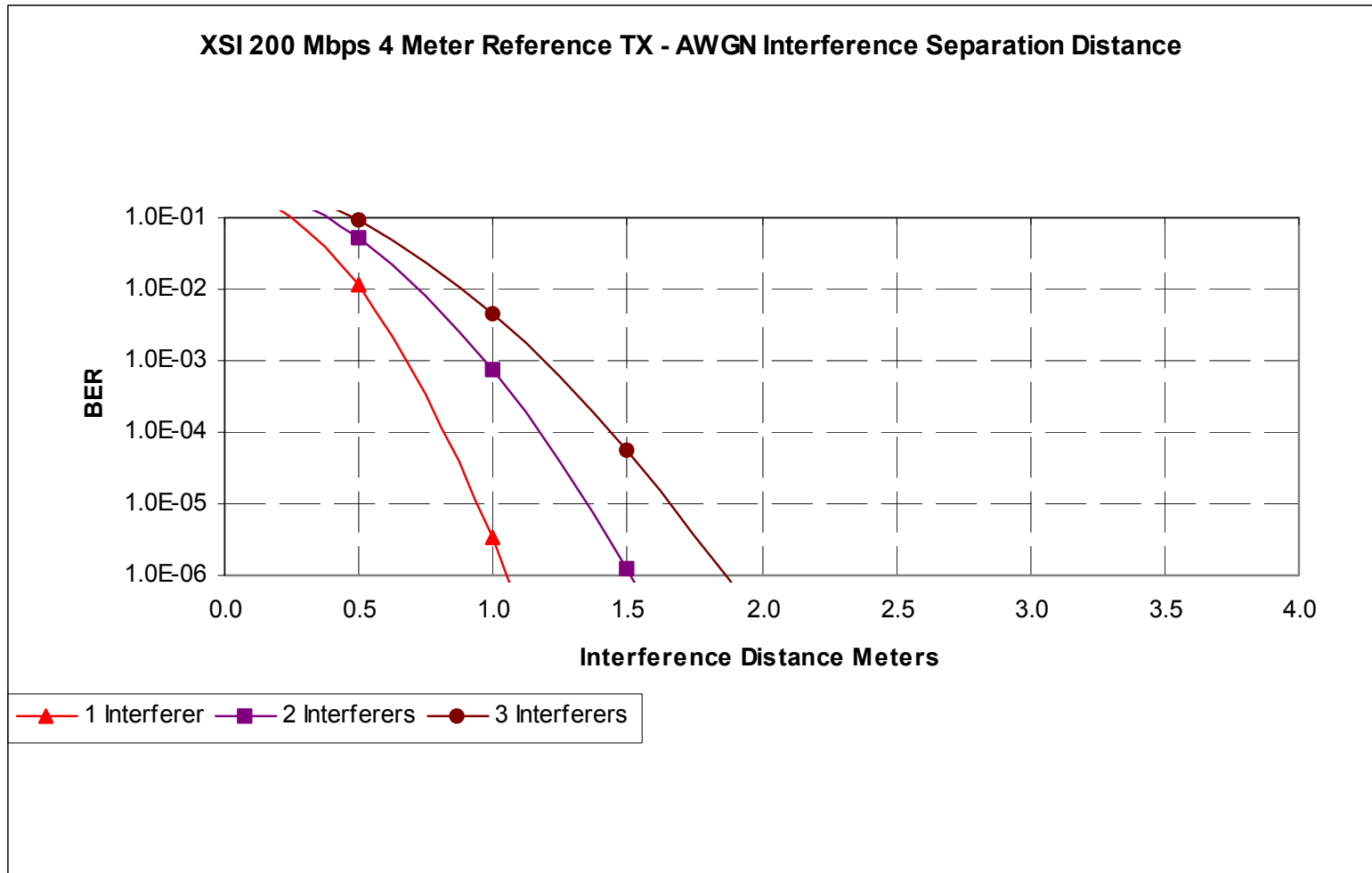

Tests are done in the Low Band, 200 Mbps, 16-BOK, Reed-Solomon FEC
Reference Link Distance: 4 meters

Multiple User Separation Distance – CM1 to CM4

May 2003

(One MUI)

doc.: IEEE 802.15-03/153r5

Summary - Mean Separation Distance – 114 Mbps – 10 meter reference

Interference Reference	CM1	CM2	CM3	CM4
CM1	4.3 m	3.4 m	2.8 m	2.6 m
CM2	6.6 m	5.1 m	4.3 m	3.9 m
CM3	9.8 m	7.7 m	6.4 m	5.8 m
CM4	10.6 m	8.2 m	6.8 m	6.3 m

Multiple User Separation Distance – CM1 to CM4

May 2003

(One MUI)

doc.: IEEE 802.15-03/153r5

Summary - Mean Separation Distance – 200 Mbps – 4 meter reference

Interference Reference	CM1	CM2	CM3	CM4
CM1	1.9 m	1.5 m	1.3 m	1.1 m
CM2	2.5 m	1.9 m	1.6 m	1.5 m
CM3	3.2 m	2.5 m	2.1 m	1.9 m
CM4	3.2 m	2.5 m	2.1 m	1.9 m



- Three Preamble Lengths (Link Quality Dependent)
 - Short Preamble (10 μ s, short range <4 meters, high bit rate)
 - Medium Preamble (default) (15 μ s, medium range ~10 meters)
 - Long Preamble (30 μ s, long range ~20 meters, low bit rate)
 - Preamble selection done via blocks in the CTA and CTR
- PHY Header Indicates FEC type, M-BOK type and PSK type
 - Data rate is a function of FEC, M-BOK and PSK setup
 - Headers are sent with 3 dB repetition gain for reliable link establishment

PHY Synchronization Preamble Sequence

(low band medium length sequence¹)

JNJNB5ANB6APAPCPANASASCNJNASK9B5K6B5K5D5D5B9ANASJPJNK5MNCPTB5CSJPMTK9MSJTCTASD9ASCTAT
ASCSANCSASJSJSB5ANB6JPN5DAASB9K5MSCNDE6AT3469RKWAVXM9JFEZ8CDS0D6BAV8CCS05E9ASRWR914A1BR

Notation is Base 32

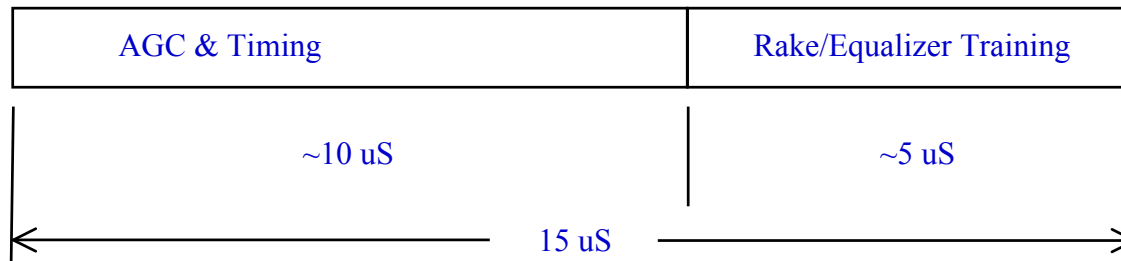

¹ see document 03/154r2 for sequences for the long, short and high band preambles

Acquisition ROC Curves

May 2003

doc.: IEEE 802.15-03/153r5

Acquisition ROC curve vs. Eb/No at 114 Mbps

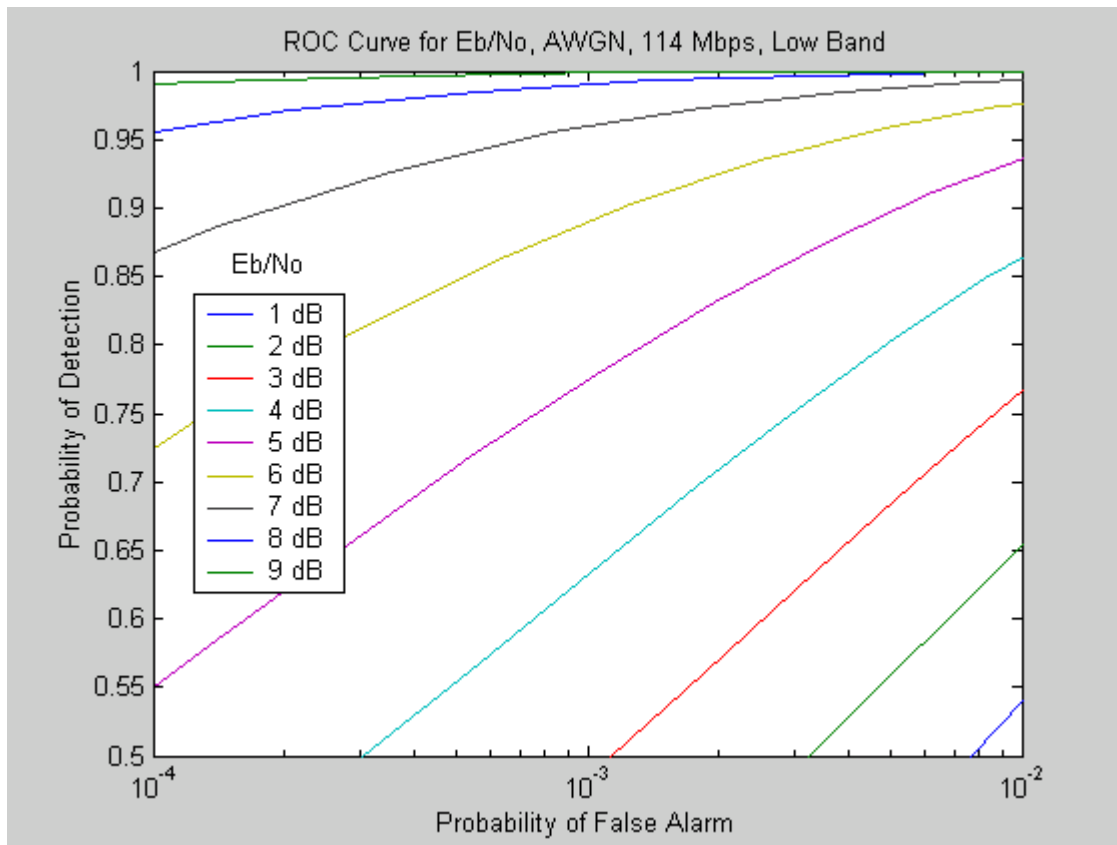

ROC Probability of detection vs. Eb/No at 114 Mbps for Pf=0.01

114 Mbps Eb/No	Pd
9 dB	1.0
8 dB	0.999
7 dB	0.994
6 dB	0.976
5 dB	0.935
4 dB	0.865
3 dB	0.770
2 dB	0.655
1 dB	0.540

Acquisition Assumptions and Comments

Timing acquisition uses a sliding correlator that searches through the multi-path components looking for the best propagating ray

Two degrees of freedom that influence the acquisition lock time (both are SNR dependent):

1. The time step of the search process
2. The number of sliding correlators

Acquisition time is a compromise between:

- acquisition hardware complexity (i.e. number of correlators)
- acquisition search step size
- acquisition SNR (i.e. range)
- acquisition reliability (i.e. P_d and P_f)

Acquisition Assumptions and Comments (cont.)

We've limited the number of correlators during acquisition to three and we've presented results against a 15 μ S preamble length.

Naturally we could have shortened the acquisition time by increasing the acquisition hardware complexity. Our acquisition performance numbers are not absolutes but arise due to our initial assumptions.

Acquisition Assumptions and Comments (cont.)

Task Group 3a has indicated four Channel Model types but never specified path loss exponents to be used during these evaluations. XtremeSpectrum has used the following mean (ensemble average) peak path loss exponents:

CM1: $r^{2.0}$

CM2: $r^{2.5}$

CM3: $r^{3.0}$

CM4: $r^{3.5}$

The path loss exponent has an huge impact on the performance range numbers (meters of distance). We ask reviewers to keep this in mind when reviewing the proposals.

90%'tile Acquisition Distance vs. Channel Type

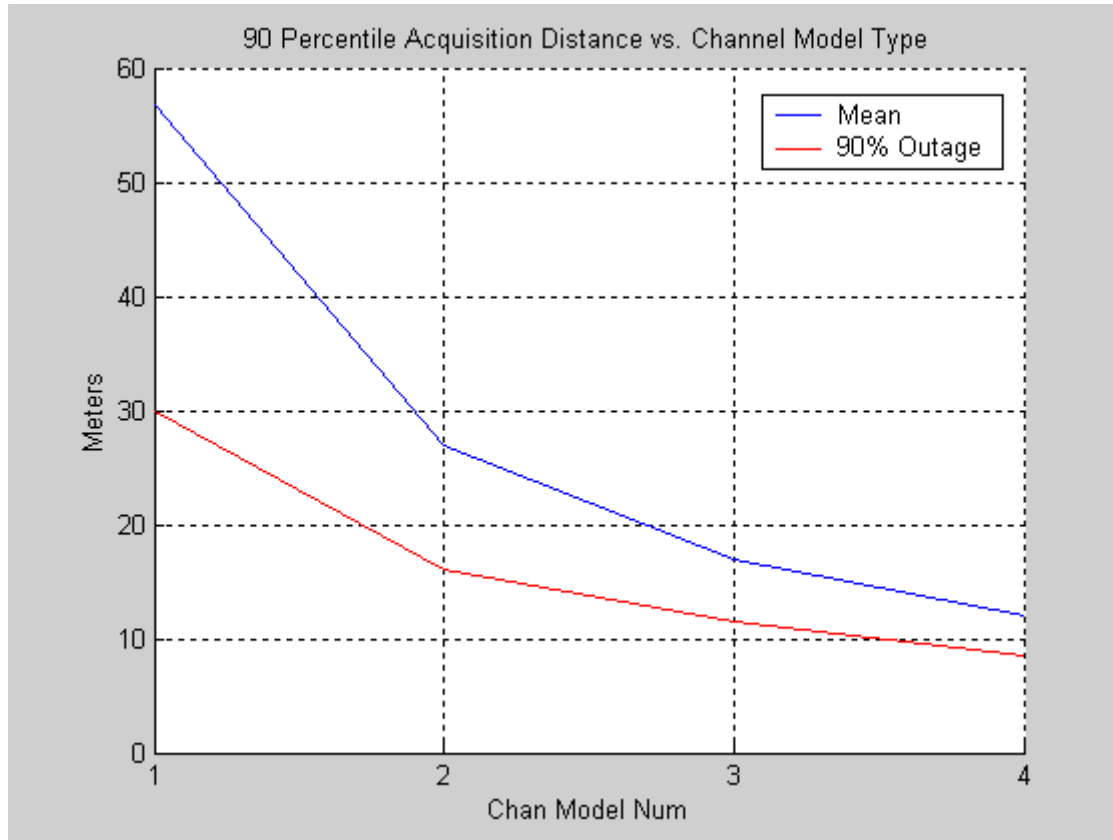

Plot is for the Low Band

Packet Error Rate Curves

May 2003

doc.: IEEE 802.15-03/153r5

114 Mbps Channel PER Curves – 16-BOK, 1/2 Convolutional

The following exponentials were used on the path loss equation: CM1: r^2 ; CM2: $r^{2.5}$; CM3: r^3 ; CM4: $r^{3.5}$.

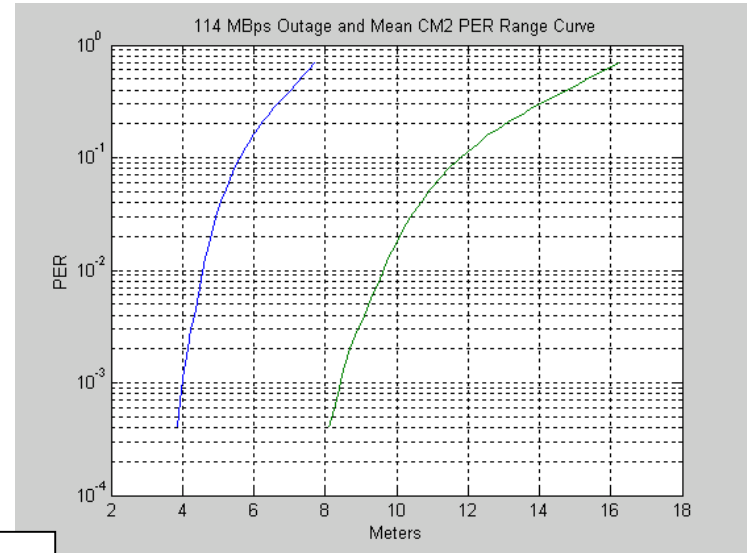
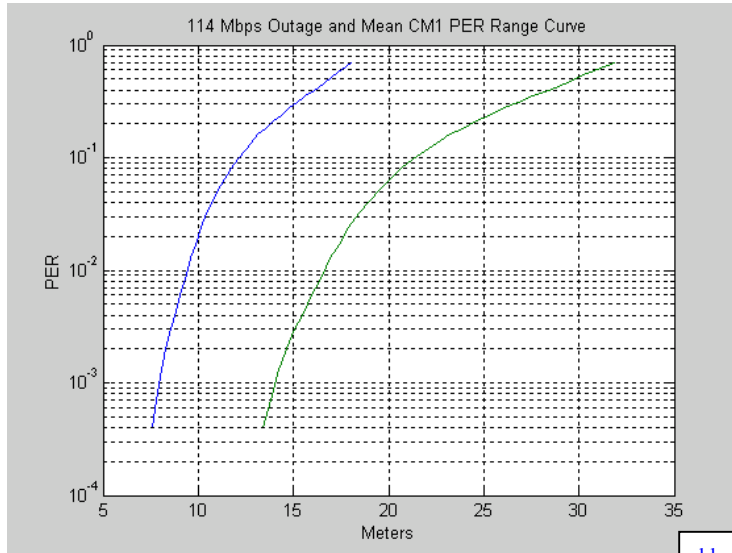

blue=outage
green=mean

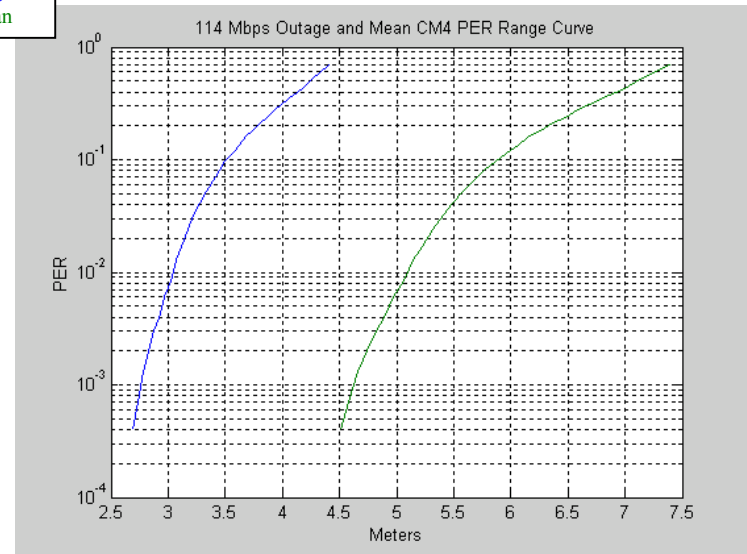
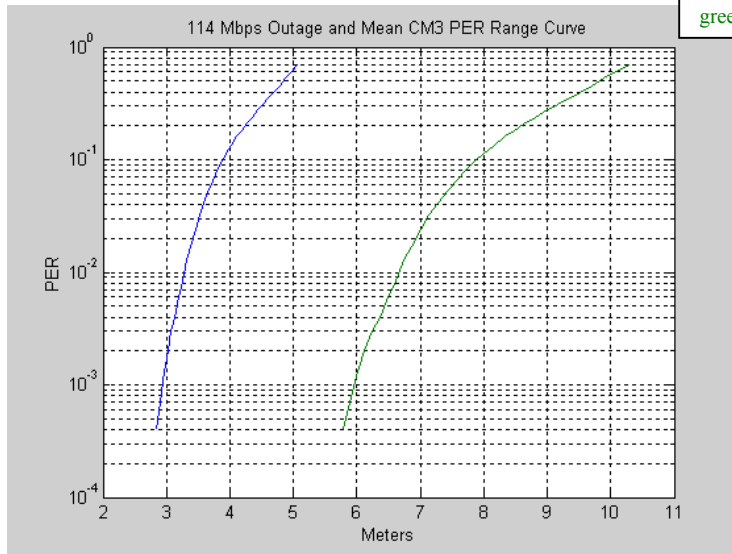

Packet Error Rate Curves (cont.)

doc.: IEEE 802.15-03/153r5

May 2003

200 Mbps Channel PER Curves – 16-BOK, Reed-Solomon

The following exponentials were used on the path loss equation: CM1: r^2 ; CM2: $r^{2.5}$; CM3: r^3 ; CM4: $r^{3.5}$.

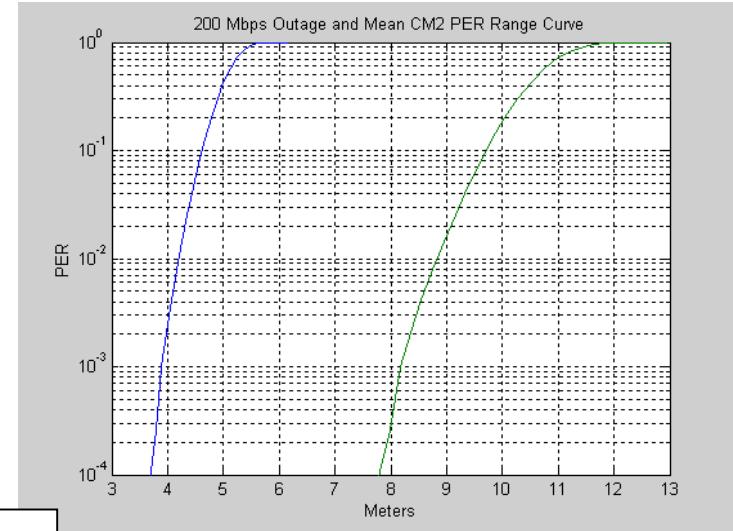
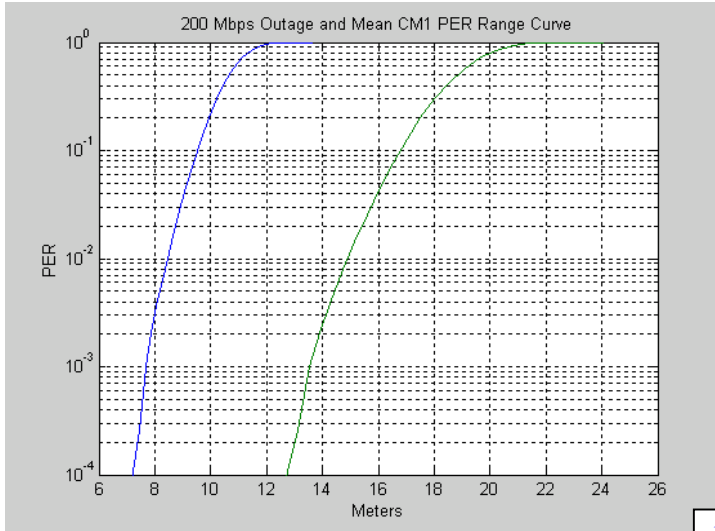

blue=outage
green=mean

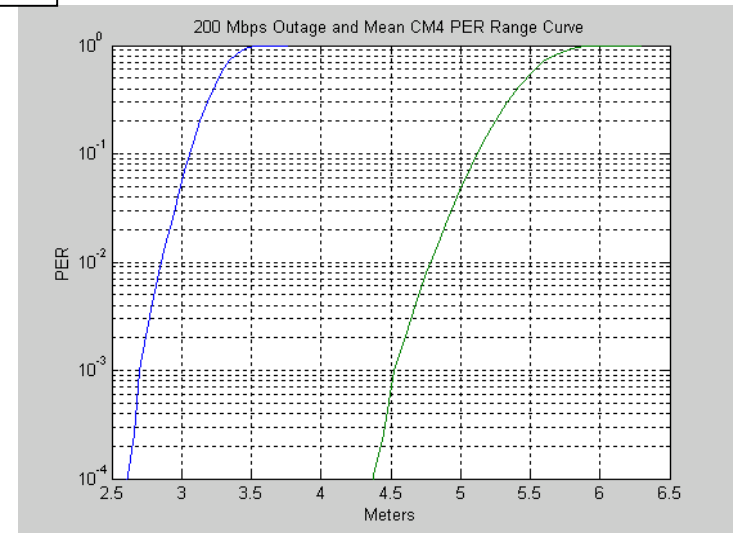
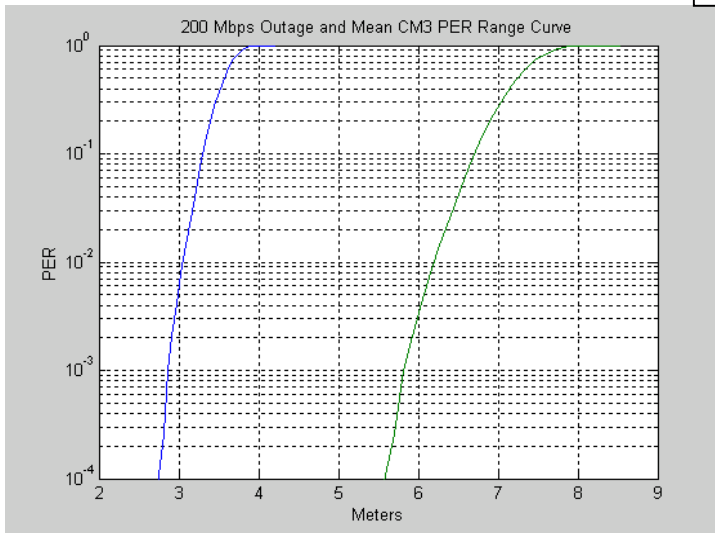

1. XSI - CDMA

- The XSI CDMA codes offer some processing gain against narrowband interference (<14 dB)
- Better NBI protection is offered via tunable notch filters
 - Specification outside of the standard
- Each notch has an implementation loss <3 dB (actual loss is implementation specific)
- Each notch provides 20 to 40 dB of protection
- Uniform sampling rate facilitates the use of DSP baseband NBI rejection techniques

2. Comparison to Sub-banding Multi-bander NBI Approach

- Sub-banding Multi-banders propose turning off sub-bands that have interference
 - RF notch filtering is still required to prevent RF front end overloading
- If the interference falls near a sub-band boundary then could turn off two sub-bands
 - Sub-band frequency response has gradual roll-off, poor out-of-band NBI rejection
- Turning off a sub-band impacts the TX power and causes degraded performance
- Dropping a sub-band requires either one of the following:
 - FEC across the sub-bands
 - Can significantly degrade FEC performance
 - Handshaking between TX and RX to re-order the sub-band bit loading
 - Less degradation but more complicated at the MAC sublayer

All rates in Mbps, times in μ s							
PHY Header bits	24						
MAC Header Bits	80						
HCS bits	16						
Header Bits	120						
Payload Bytes	1024						
Payload Bits	8192						
FCS Bits	32						
FEC Overhead symbols (conv)	730						
FEC Overhead symbols (RS)	3112						
Symbol Rate	57						
Header equivalent "FEC" rate	0.333333						
Header BOK bits per symbol	1						
Initial PHY Header rate	19						
FEC		conv	conv	concat	conv	R/S	R/S
Bit Rate		28.5	57	75	114	200	400
FEC symbol rate		57	114	171.5247	228	228.6996	457.3991
BOK		2	3	8	16	16	16
BPSK/QPSK		BPSK	BPSK	BPSK	BPSK	BPSK	QPSK
Bits per symbol		1	2	3	4	4	8
Payload FEC rate		0.5	0.5	0.437255	0.5	0.87451	0.87451
T_PA_INITIAL	15						
T_PA_CONT	0						
T_PHYHDR_INITIAL	1.263158						
T_MACHDR_INITIAL	4.210526						
T_HCS_INITIAL	0.842105						
T_PHYHDR_CONT		0.842105	0.421053	0.32	0.210526	0.12	0.06
T_MACHDR_CONT		2.807018	1.403509	1.066667	0.701754	0.4	0.2
T_HCS_CONT		0.561404	0.280702	0.213333	0.140351	0.08	0.04
T_MPDU		287.4386	143.7193	109.2267	71.85965	40.96	20.48
T_FCS		1.122807	0.561404	0.426667	0.280702	0.16	0.08
T_SIFS	5	5	5	5	5	5	5
T_FEC_OH		12.80702	6.403509	22.39911	3.201754	13.60737	6.803686
T_MIFS	0	0	0	0	0	0	0
T_ONE_FRAME		327.6842	177	158.3682	101.6579	81.04316	53.67948
Throughput_1		24.99968	46.28249	51.72755	80.584	101.0819	152.6095
T_FIVE_FRAMES		1498.772	762.5439	603.3816	394.4298	247.9232	137.1195
Throughput_5		27.32904	53.71494	67.88408	103.8461	165.2125	298.7176

Low Band Results,
See 03/154r2 for High Band Results

We've limited the number of correlators during acquisition to three. These results are for a 15 μ s preamble length.

No significant MAC or superframe modifications required!

- From MAC point of view, 8 available logical channels
- Band switching done via DME writes to MLME

Proposal Offers MAC Enhancement Details (complete solution)

- PHY PIB
 - RSSI, LQI, TPC and CCA
- Clause 6 Layer Management Enhancements
 - Ranging MLME Enhancements
 - Multi-band UWB Enhancements
- Clause 7 MAC Frame Formats
 - Ranging Command Enhancements
 - Multi-band UWB Enhancements
- Clause 8 MAC Functional Description
 - Ranging Token Exchange MSC

Additional Information can be found in doc 03/154r2 including XSI draft text for the standard (in the appendix of 03/154r2).

802.15.3a Early Merge Work

XtremeSpectrum will be cooperating with Motorola

6.1 General Solution Criteria

CRITERIA	REF.	IMPORTANCE LEVEL	PROPOSER RESPONSE
Unit Manufacturing Complexity (UMC)	3.1	B	+
<i>Signal Robustness</i>			
Interference And Susceptibility	3.2.2	A	+
Coexistence	3.2.3	A	+
<i>Technical Feasibility</i>			
Manufacturability	3.3.1	A	+
Time To Market	3.3.2	A	+
Regulatory Impact	3.3.3	A	+
Scalability (i.e. Payload Bit Rate/Data Throughput, Channelization – physical or coded, Complexity, Range, Frequencies of Operation, Bandwidth of Operation, Power Consumption)	3.4	A	+
Location Awareness	3.5	C	+

6.2 *PHY Protocol Criteria*

<i>CRITERIA</i>	<i>REF.</i>	<i>IMPORTANCE LEVEL</i>	<i>PROPOSER RESPONSE</i>
Size And Form Factor	5.1	B	+
<i>PHY-SAP Payload Bit Rate & Data Throughput</i>			
Payload Bit Rate	5.2.1	A	+
Packet Overhead	5.2.2	A	+
PHY-SAP Throughput	5.2.3	A	+
Simultaneously Operating Piconets	5.3	A	+
Signal Acquisition	5.4	A	+
System Performance	5.5	A	+
Link Budget	5.6	A	+
Sensitivity	5.7	A	+
Power Management Modes	5.8	B	+
Power Consumption	5.9	A	+
Antenna Practicality	5.10	B	+

6.3 MAC Protocol Enhancement Criteria

<i>CRITERIA</i>	<i>REF.</i>	<i>IMPORTANCE LEVEL</i>	<i>PROPOSER RESPONSE</i>
MAC Enhancements And Modifications	4.1.	C	+

Back-up Support Slides

Key Features Meet Application Requirements

- Multi-User (Multi-Piconet) Capable
 - Piconets are independent – my TV or PC doesn't coordinate/sync with my neighbor's
 - Every network supports full data-rate
 - Even at extended data rates
 - Allows very close adjacent piconets
 - Two apartments with antennas on opposite sides of the same wall
- Streaming Video Capable
 - High QOS, High Speed, Low Latency
 - Works In Home/Office/Warehouse RF environments -- Dense & High Multipath
- Low Complexity
 - Small Die Size, Low Parts Count – Low Cost
 - Low Power – Light-Weight Long-Life Batteries

Key Features Meet Application Requirements

- Spectrally Efficient¹
 - Meet Regulations and Coexists with others
 - Proven — 802.11a,b – Cordless & Cell Phones (.9, 2.4, 5.8 GHz) – Microwave ovens – GPS
 - Modulation results low Eb/No – Highest data-rate & range versus TX emission level.
 - Coded modulation method allows future growth
- Growth Path To Higher Data Rates With Backward Compatibility
 - Architecture allows component (FEC, each receiver channel, etc) usage to be adjusted such that incremental hardware additions result in the highest incremental SNR improvement.

Note 1: Reference doc IEEE802.15-03/211

DFE (Decision Feedback Equalization) used for LOS channels and NLOS channels (dotted red line represents theoretical performance). Results shown for High Band, Symbol Duration=1/114e6 seconds.

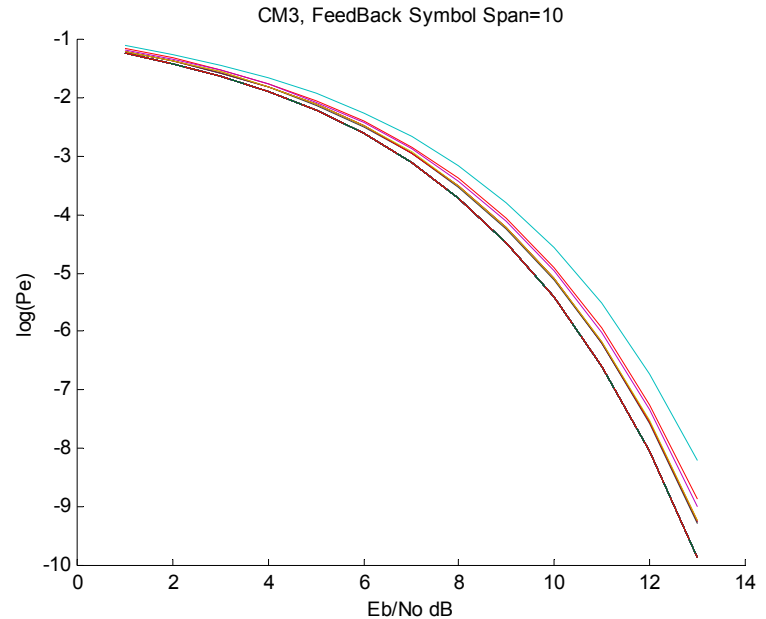
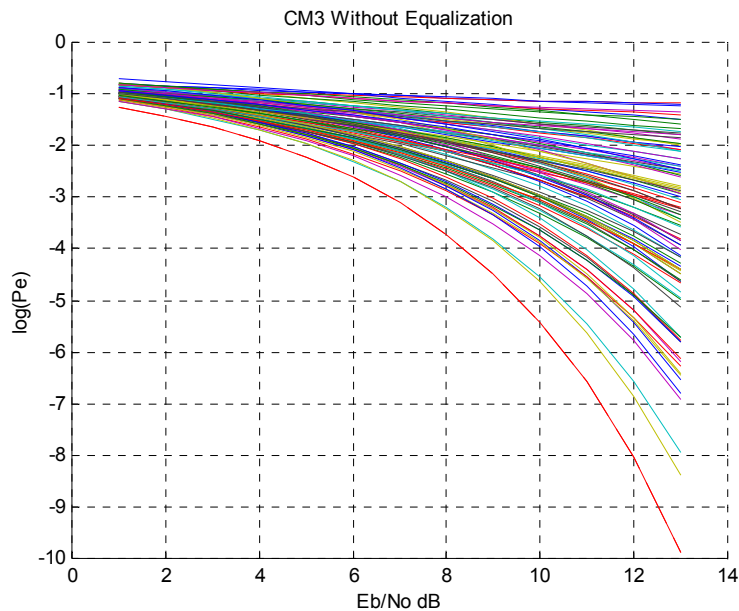

M-BOK (M=4) Illustration

May 2003

doc.: IEEE 802.15-03/153r5

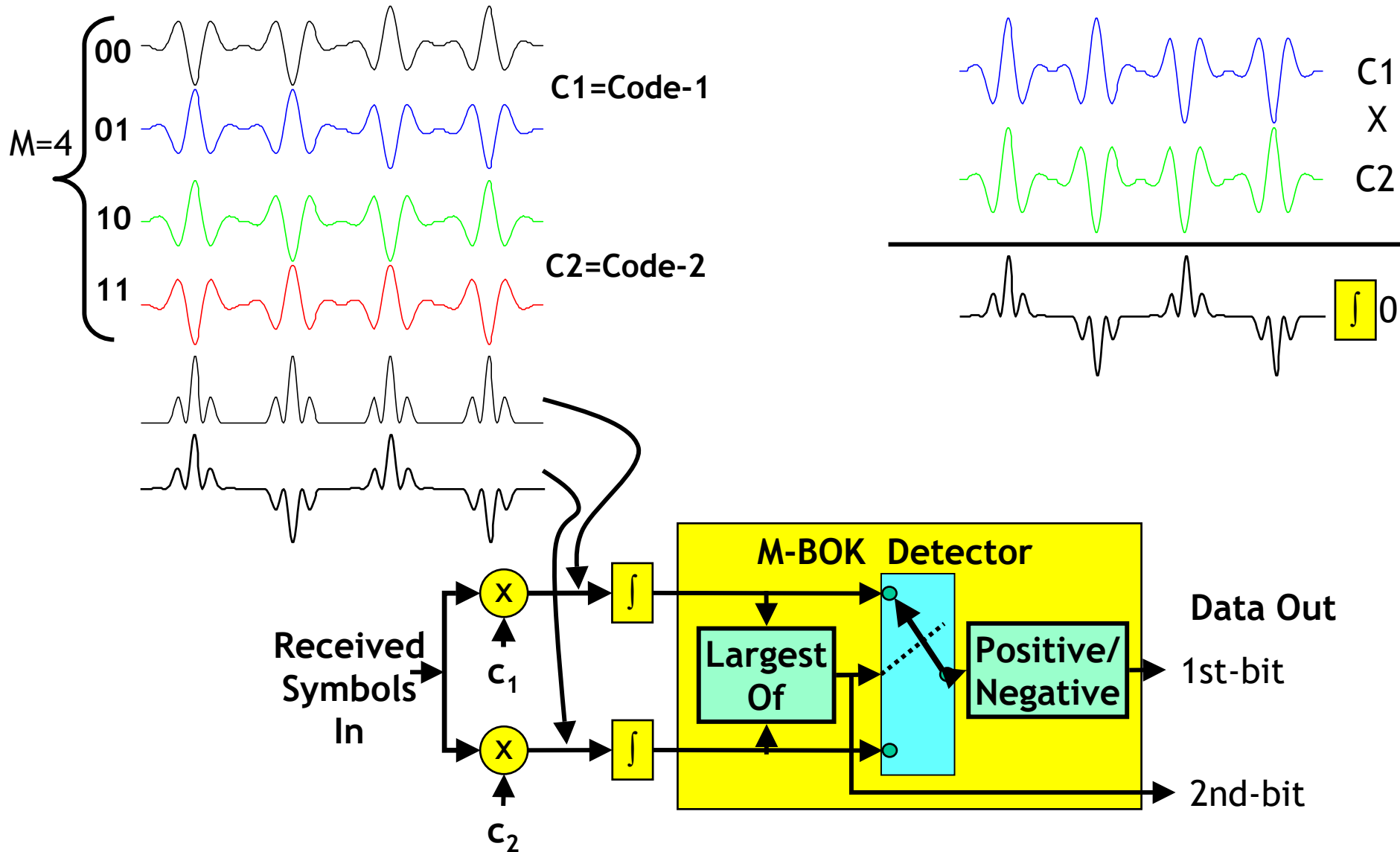

- MBOK used to carry multiple bits/symbol
- MBOK exhibits coding gain compared to QAM

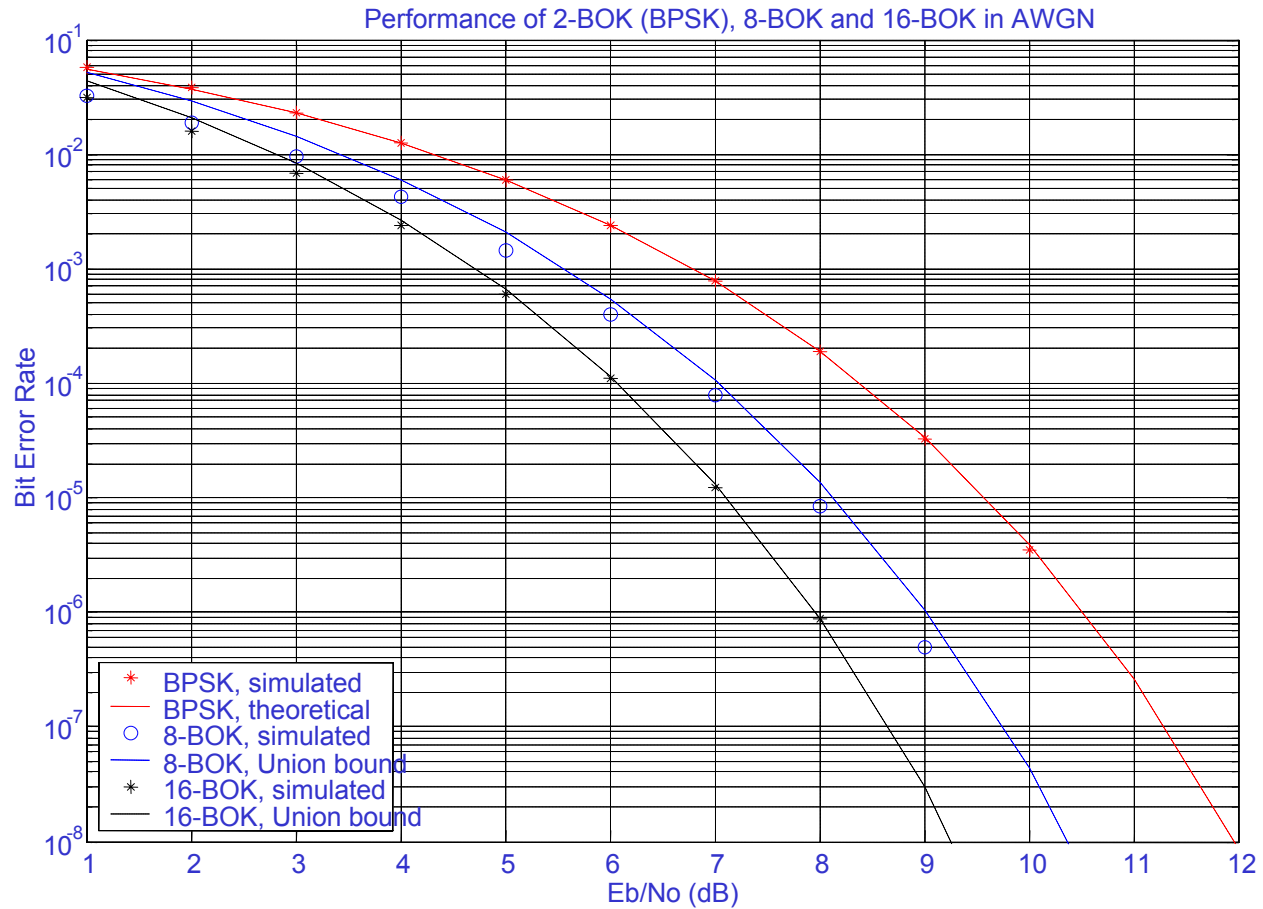

16-BOK with 1/2 Rate CC Coding Gain

May 2003

doc.: IEEE 802.15-03/153r5

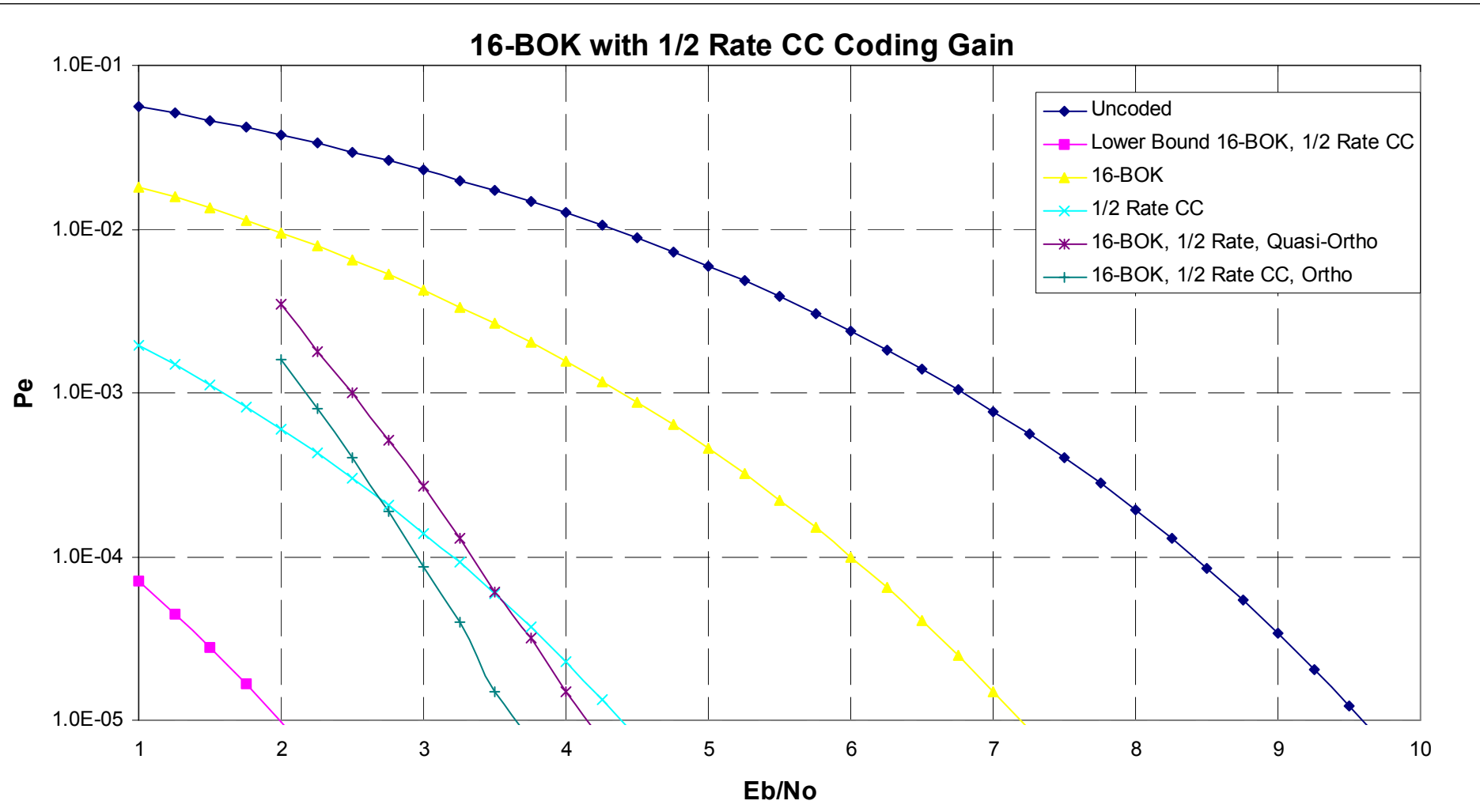

We are falling above the lower bound ... this is due to sub-optimal soft decision mapping of the BOK symbols to bits. This is on-going work and we expect to have this resolved in the near future.

16-BOK with RS(255,223) Coding Gain

May 2003

doc.: IEEE 802.15-03/153r5

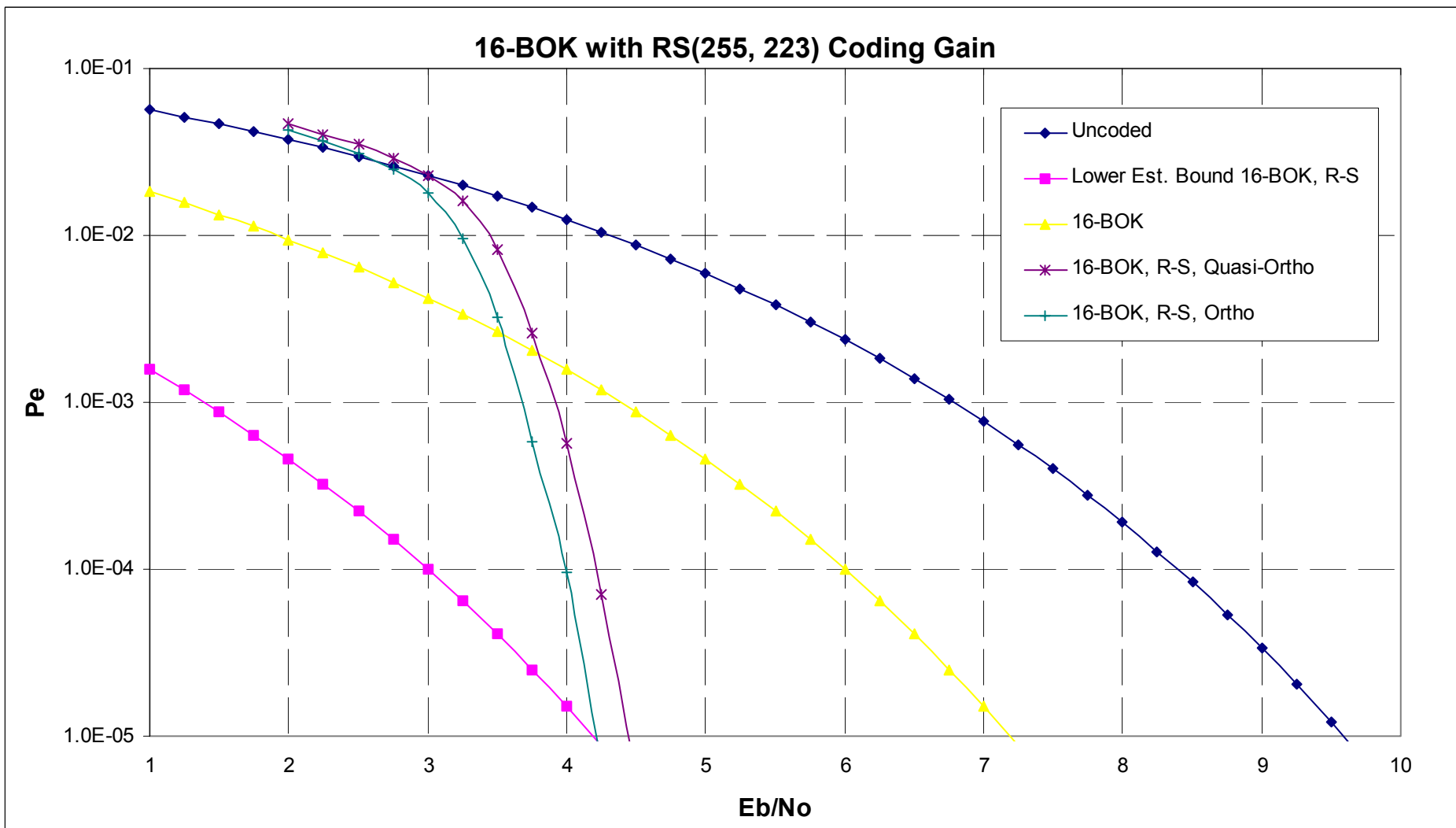

The lower bound estimate was actually done only at $10e-5$; so while the lower bound is exact at $10e-5$, it is only an estimate above $10e-5$. Notice that with orthogonal codes we exactly fall on the lower bound.

Technical Feasibility

- BPSK operation with controlled center frequency has been demonstrated in the current XSI chipset with commensurate chipping rates at 10 meters
- Current chipset uses convolutional code with Viterbi at 100 Mchip rate. We've traded-off Reed-Solomon vs. Viterbi implementation complexity and feel Reed-Solomon is suitable at higher data rates.
- Long preamble currently implemented in chipset ... have successfully simulated short & medium preambles on test channels.
- DFE implemented in the current XSI chipset at 100 Mbps. Existence proof is that IEEE802.11b uses DFE with CCK codes, which is a form of MBOK ... so it can be done economically.
- NBI filtering is currently implemented in the XSI chipset and has repeatedly been shown to work.

DS: direct sequence
CDMA: code division multiple access
PSK: phase shift keying
M-BOK: multiple bi-orthogonal keying
RX: receive
TX: transmit
DFE: decision feedback equalizer
PHY: physical layer
MAC: multiple access controller
LB: low band
HB: high band
RRC: root raised cosine filtering
LPF: low pass filter
FDM: frequency division multiplexing
CDM: code division multiplexing
TDM: time division multiplexing
PNC: piconet controller
FEC: forward error correction
BPSK: bi-phase shift keying
QPSK: quadri-phase shift keying
CCA: clear channel assessment
RS: Reed-Solomon forward error correction
QoS: quality of service
BER: bit error rate
PER: packet error rate
AWGN: additive white gaussian noise
ISI: inter-symbol interference
ICI: inter-chip interference
DME: device management entity
MLME: management layer entity
PIB: Personal Information Base
RSSI: received signal strength indicator
LQI: link quality indicator
TPC: transmit power control
MSC: message sequence chart
LOS: line of sight
NLOS: non-line of sight
CCK: complementary code keying
ROC: receiver operating characteristics