



Improving Fairness Performance

Gal Mor
Corrigent Systems
galm@corrigent.com



Goals

- Optimize the bandwidth utilization on the ring by implementing Virtual Output Queues (VOQ)
- Allow co-existence of stations with/without VOQ design, and stations with different number of VOQ on the same ring
 - Stations may have different number of VOQ, up to queue per destination per CoS
- Support RPR ring with different span's rate and efficient BW utilization
- Define the bandwidth management messages format



Station Model

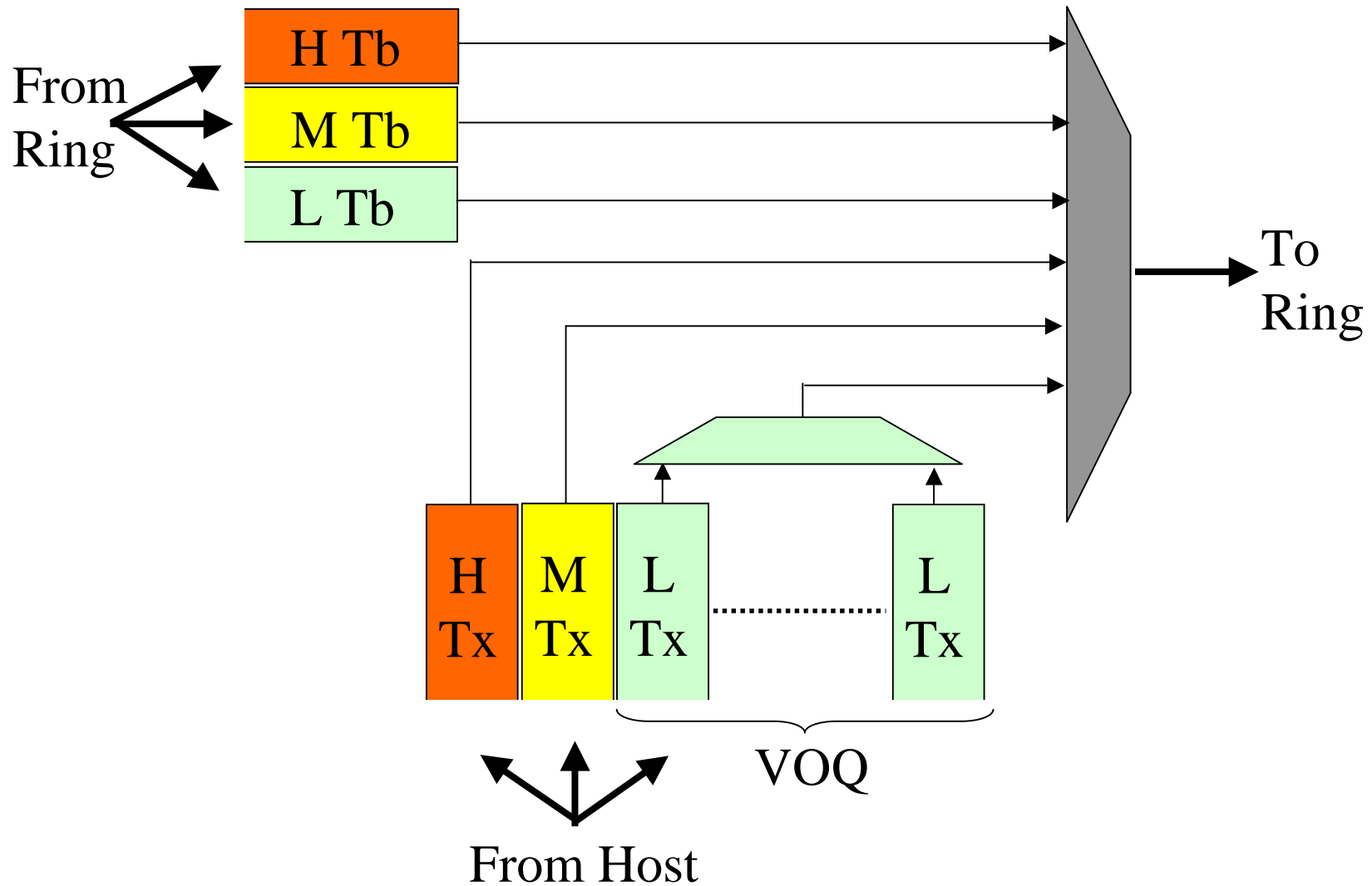



Scenario #1

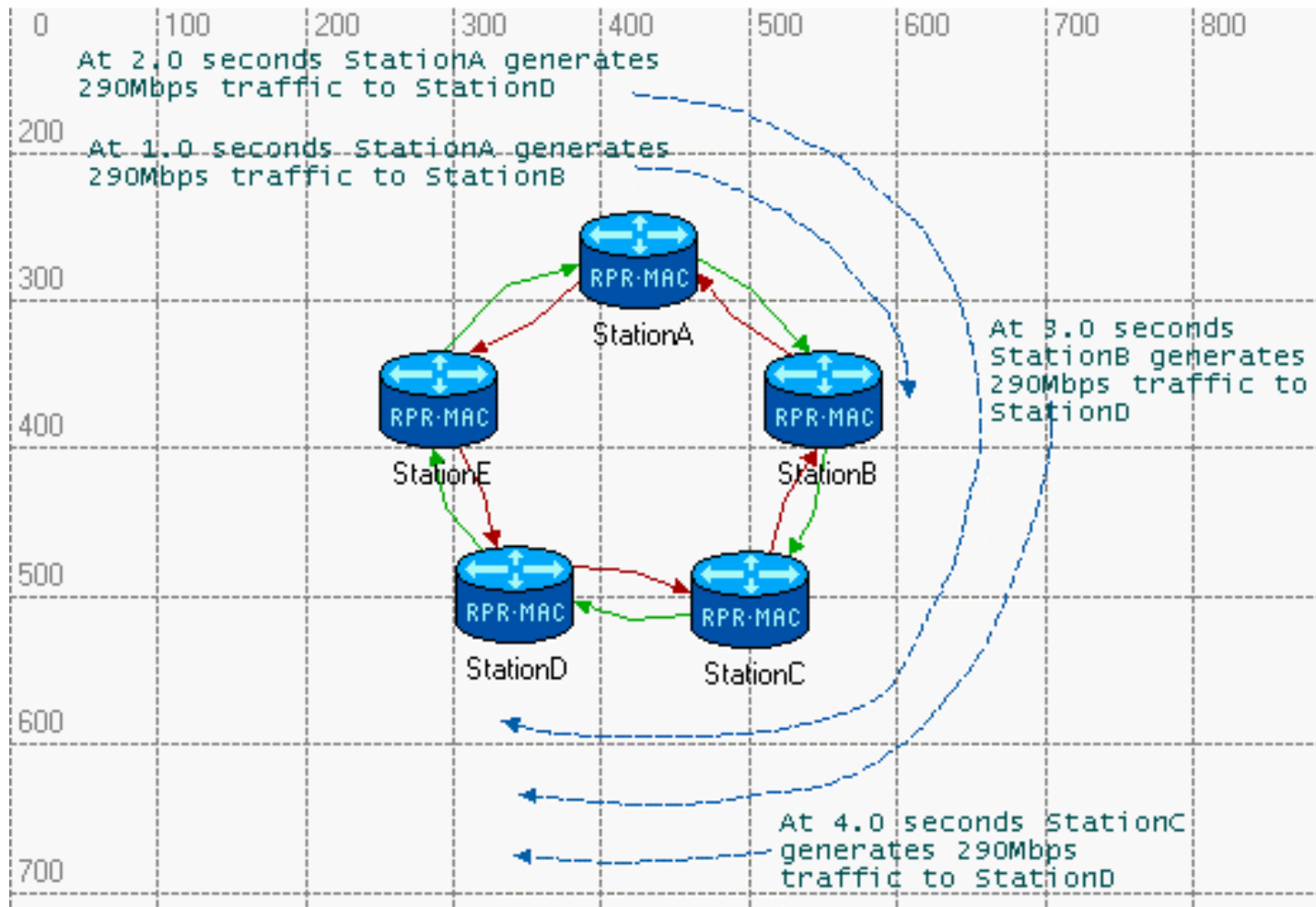



Simulation Results – Without VOQ

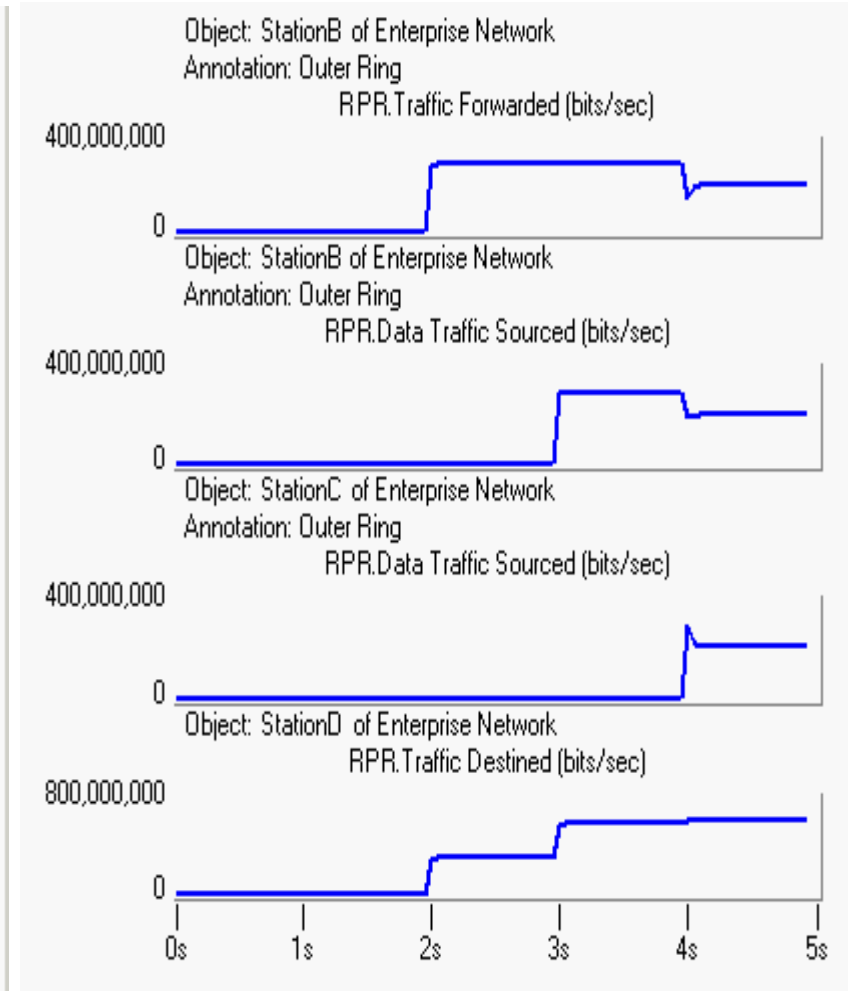
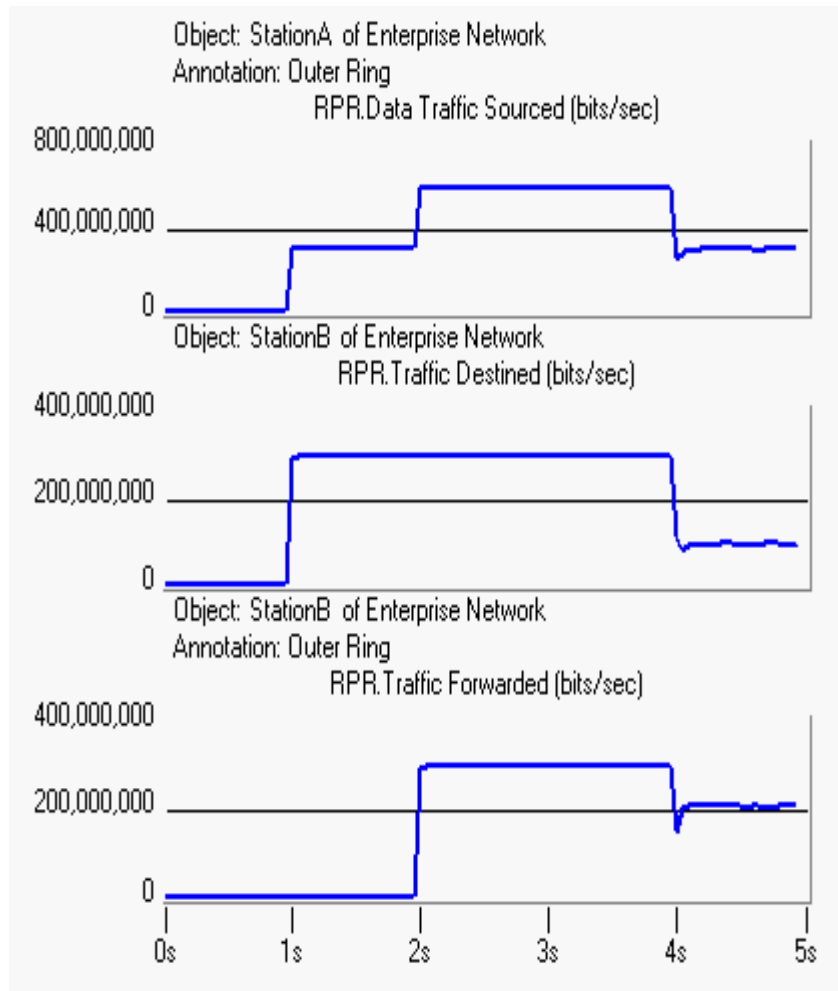



Simulation Results – With VOQ

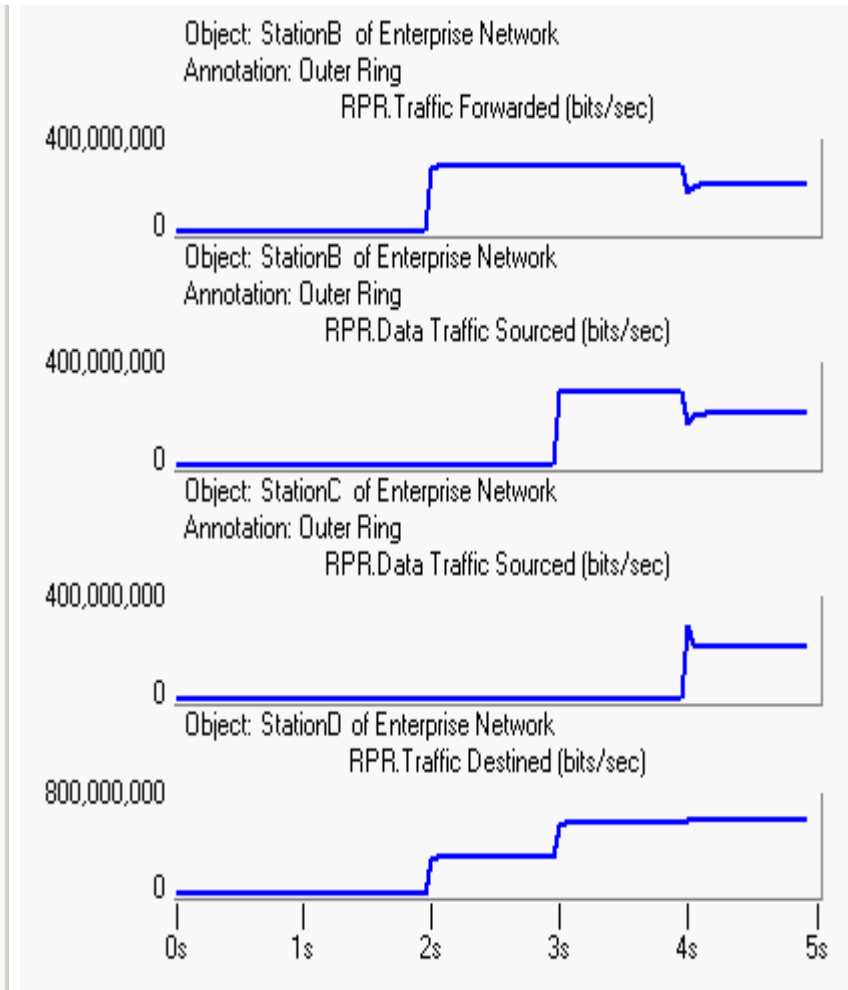
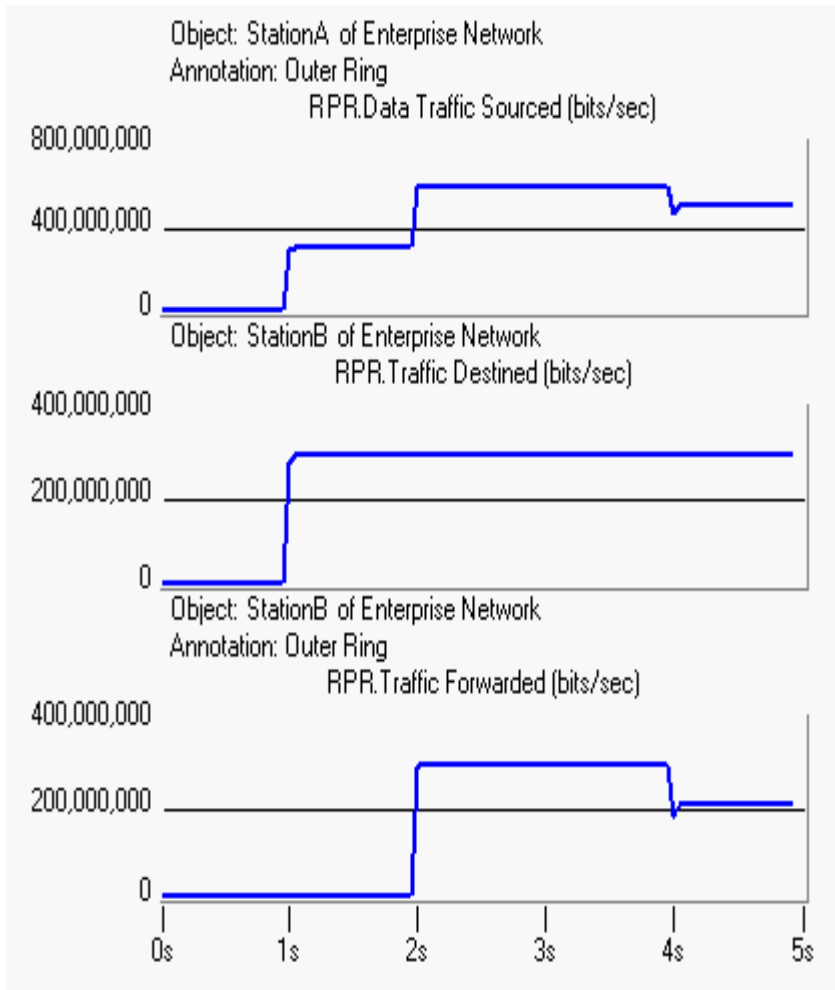



Hub Traffic Scenario

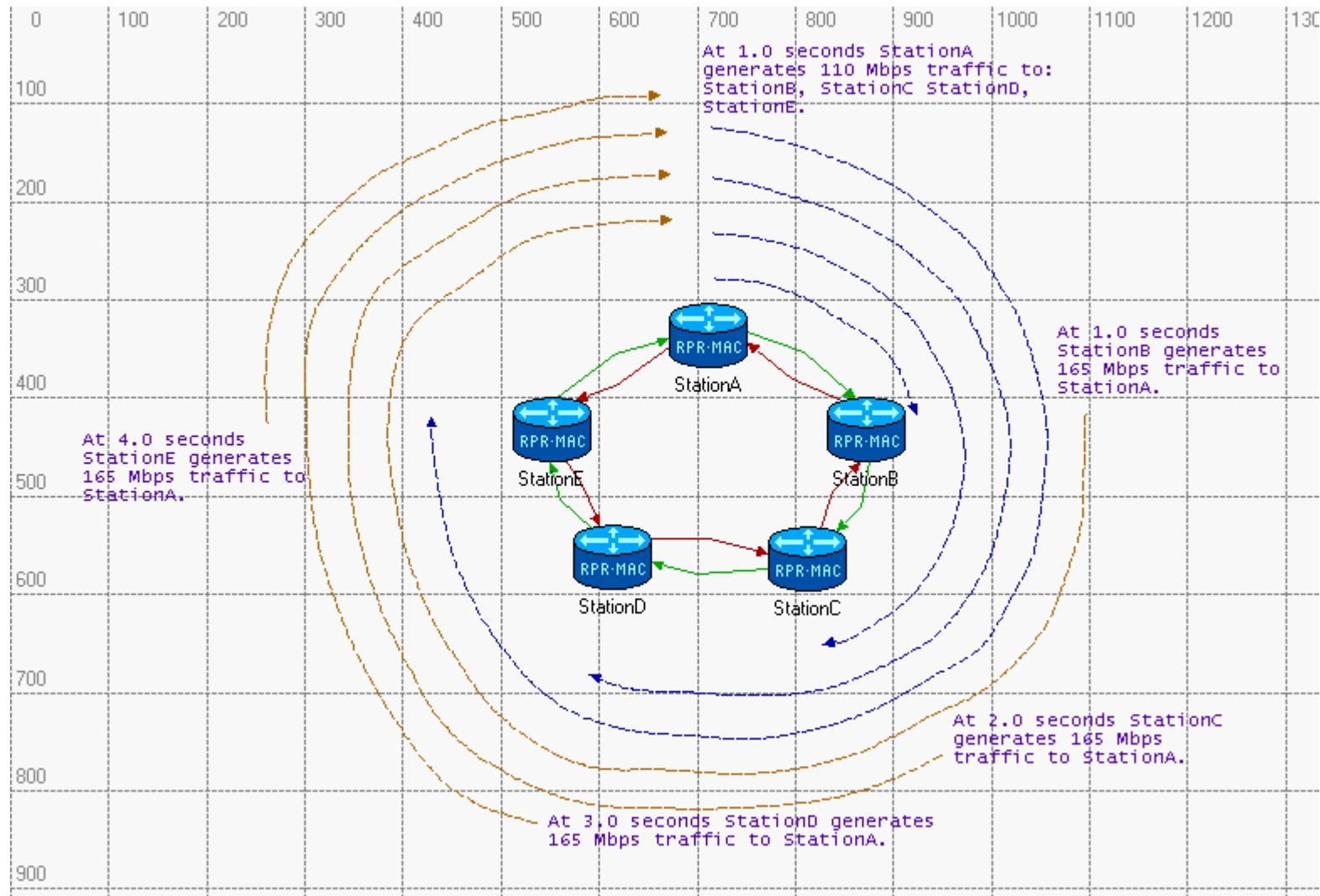



Simulation Results – Without VOQ

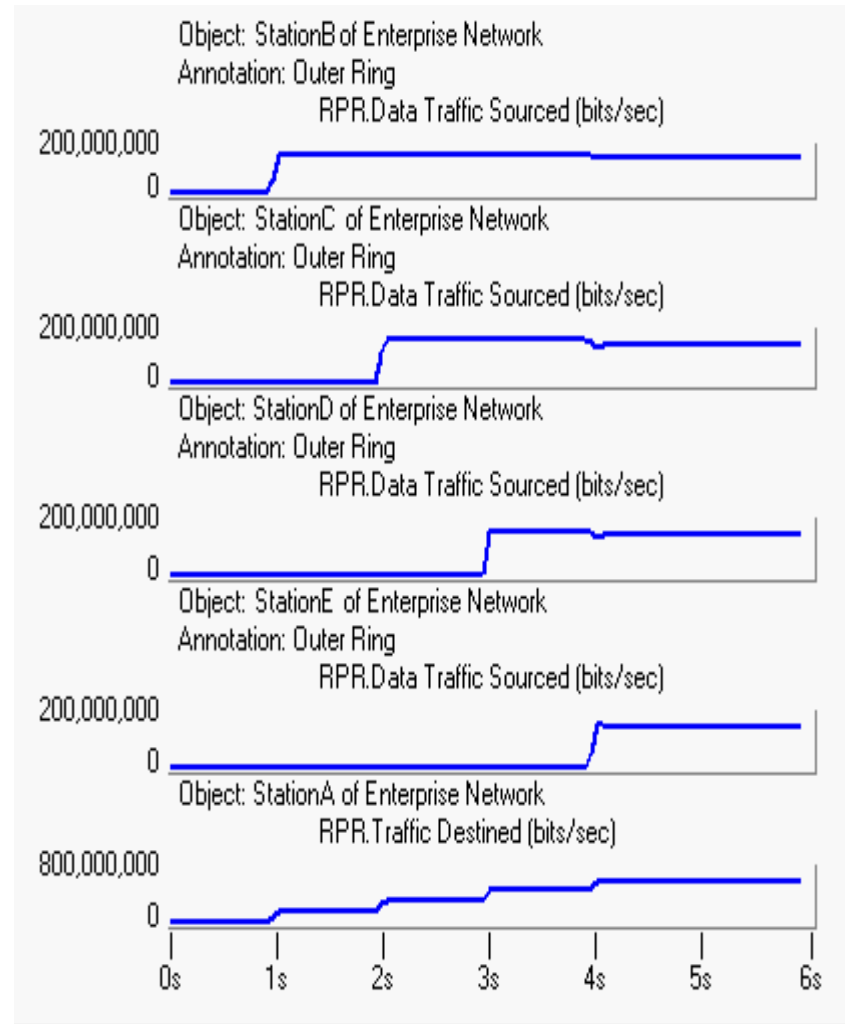
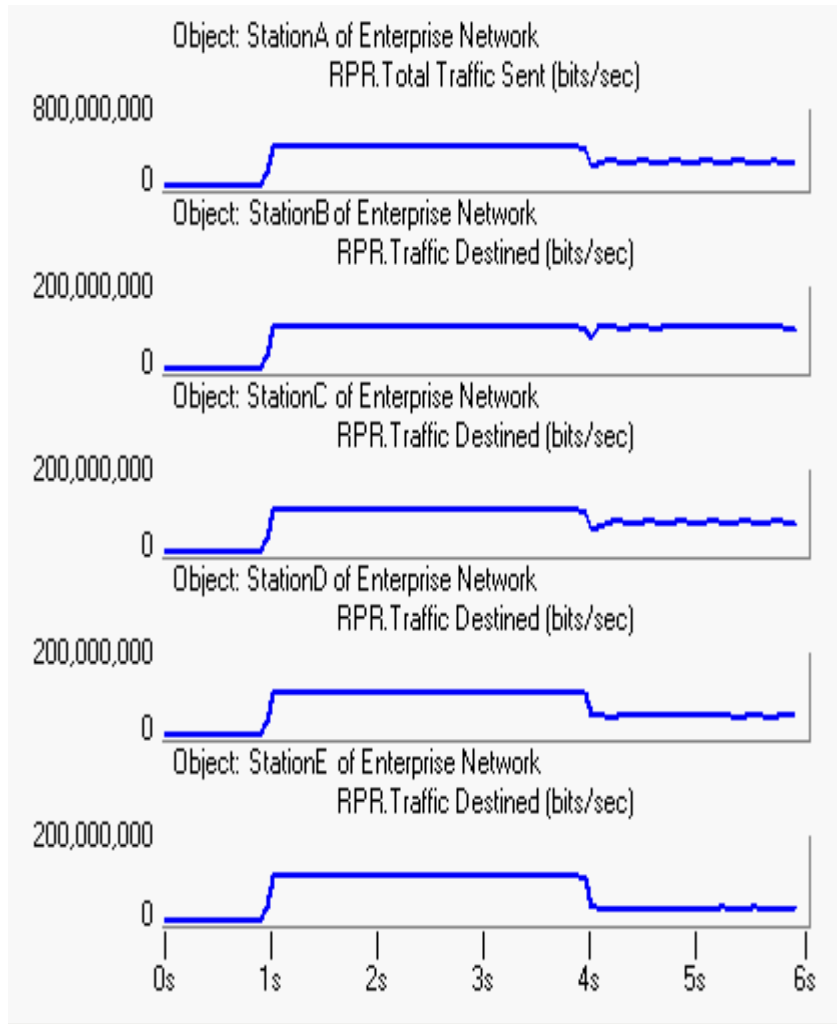



Simulation Results – With VOQ

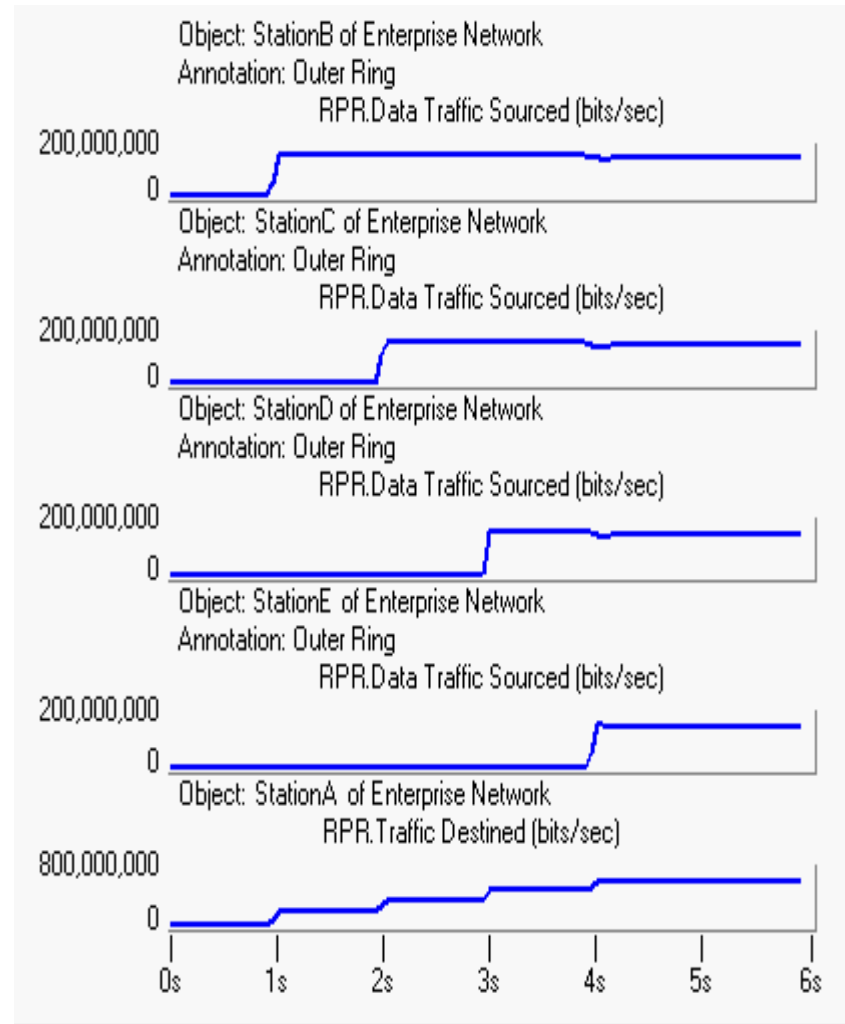
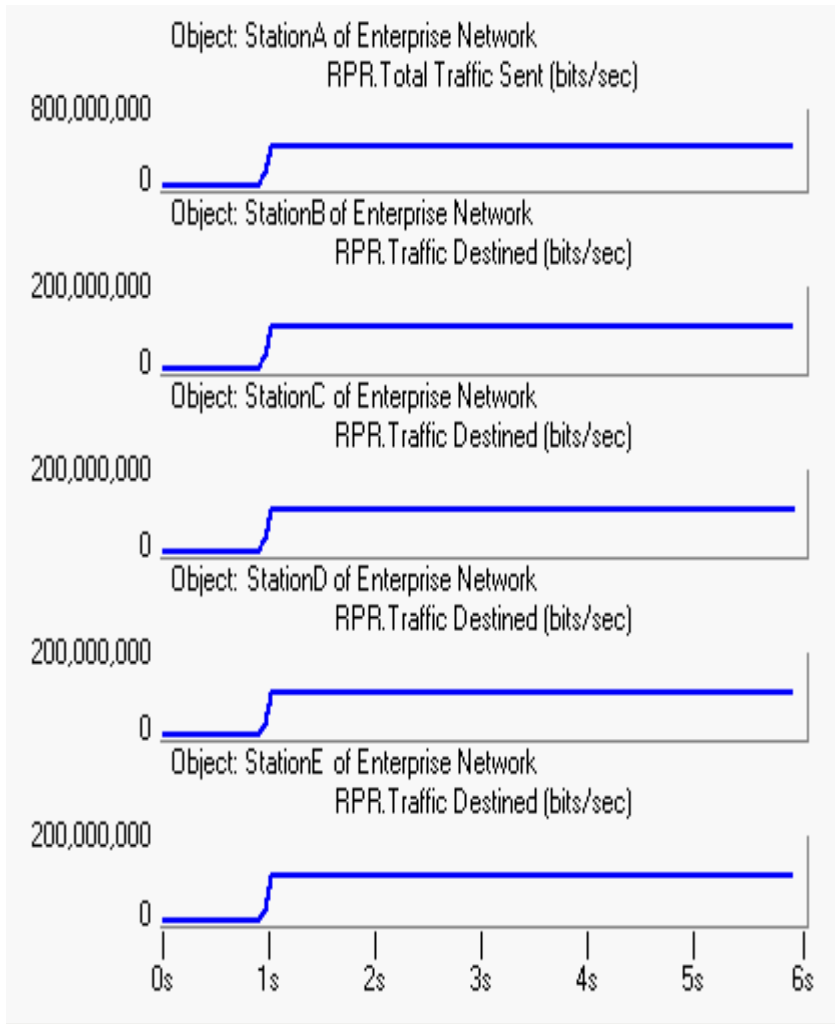



Mixed Ring

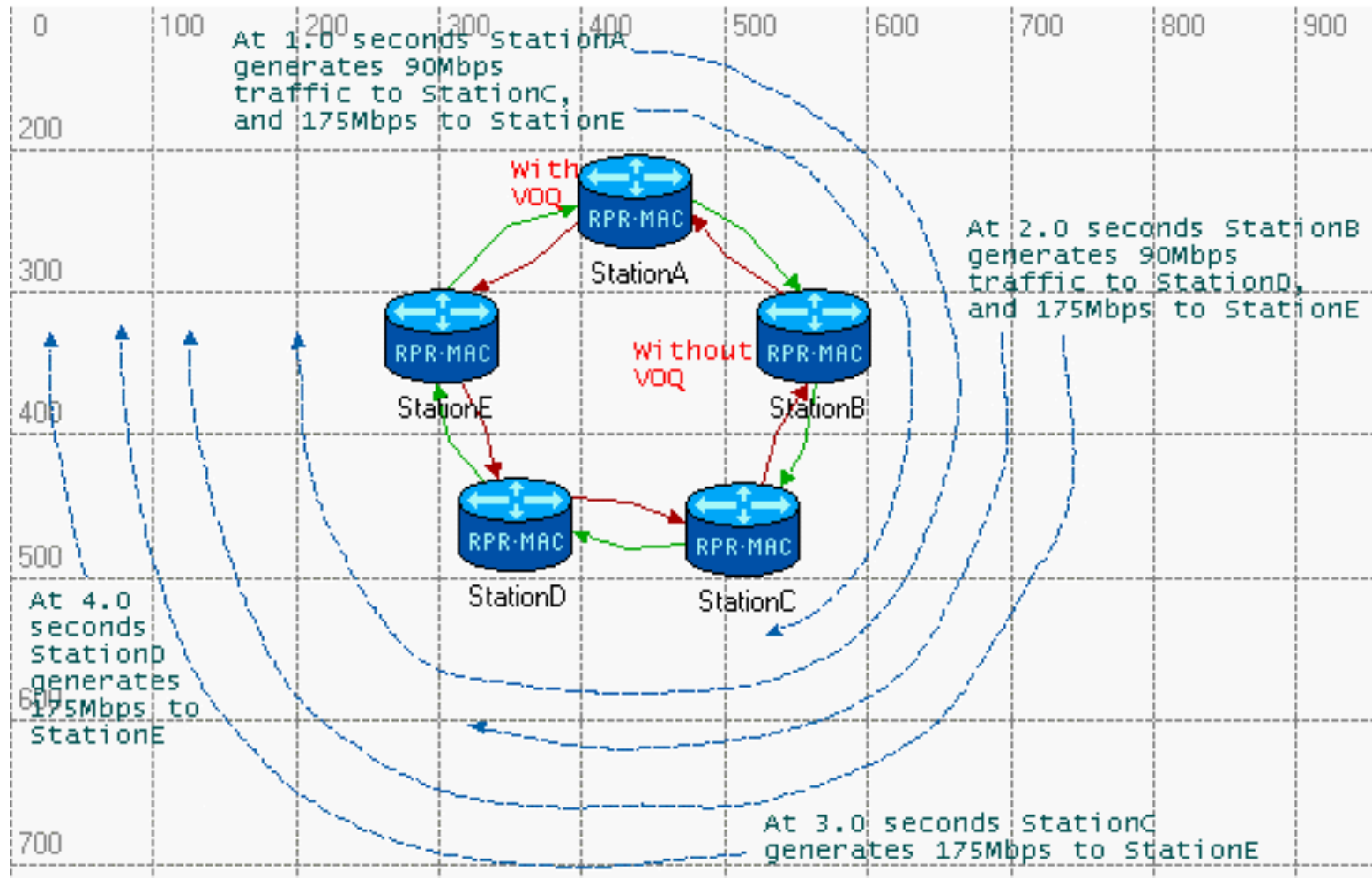



Simulation Results

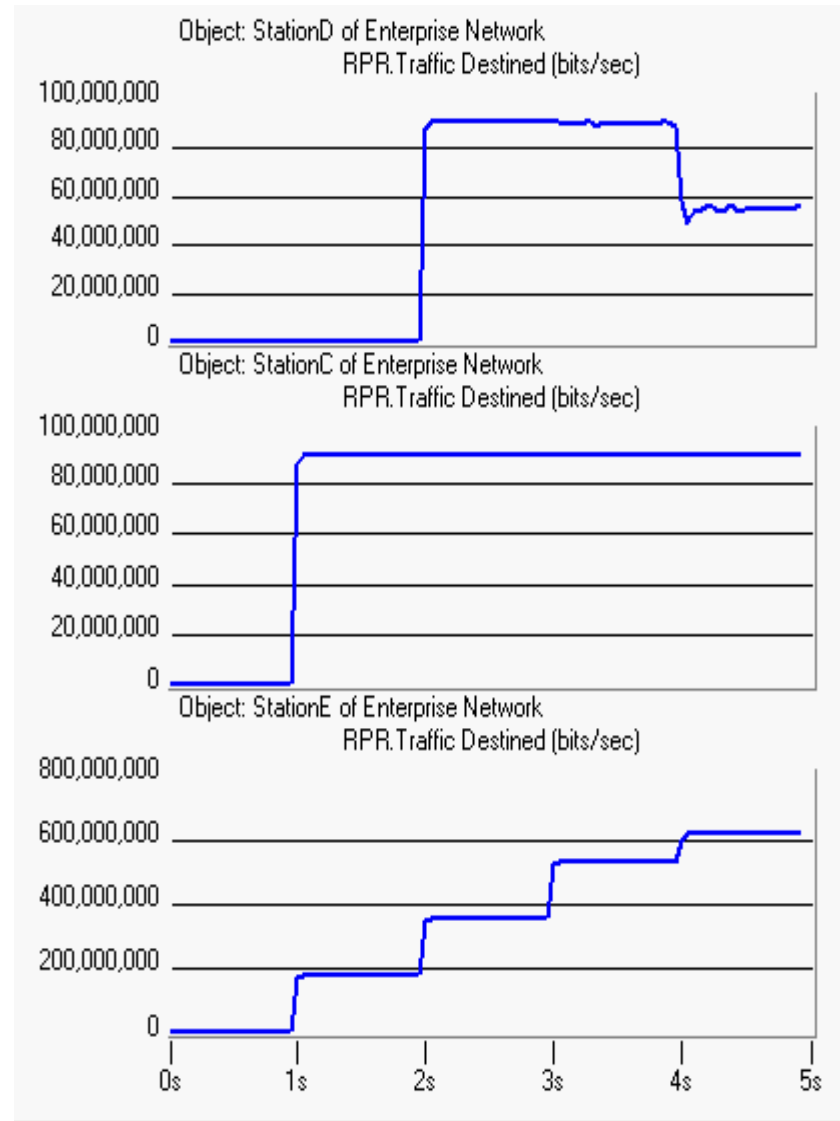
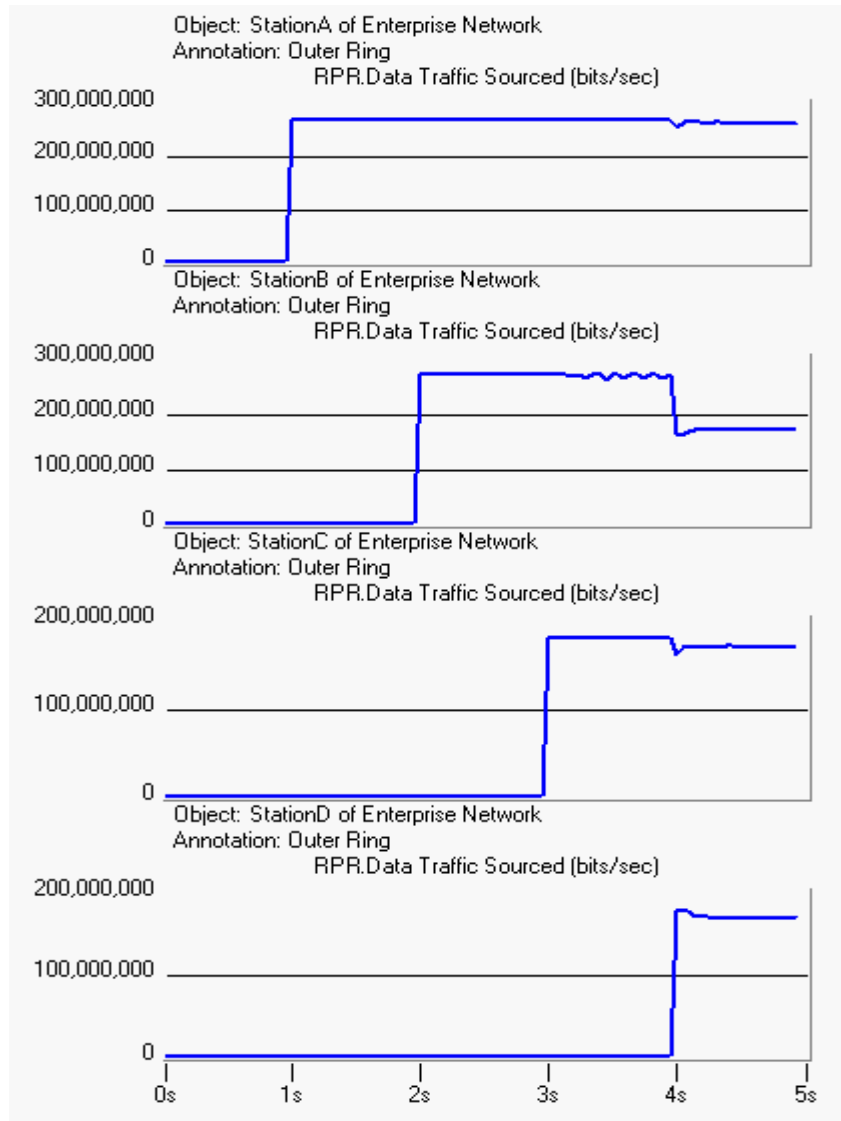



Ring with Multiple Span's Rate

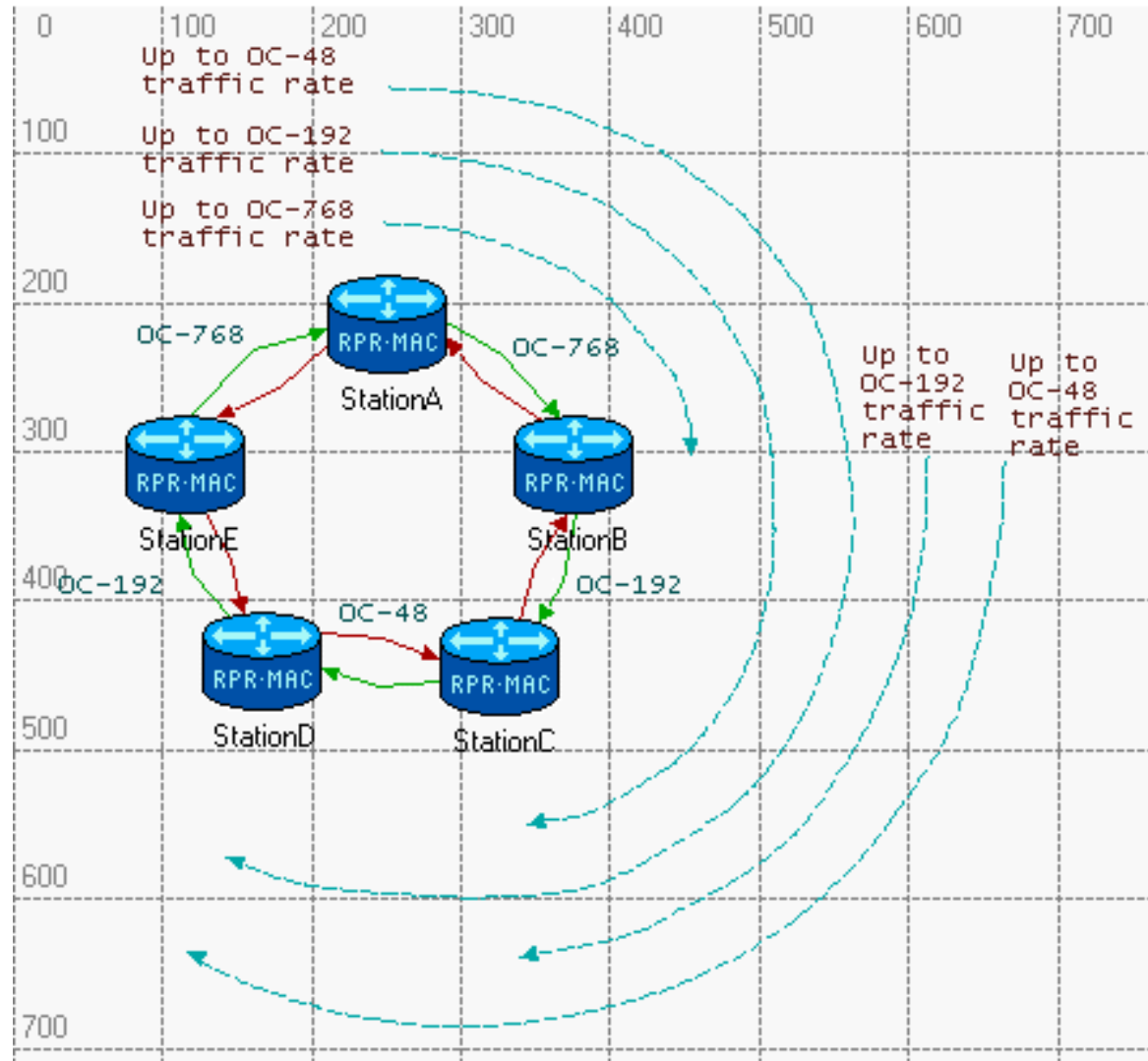



Congestion Message Frame

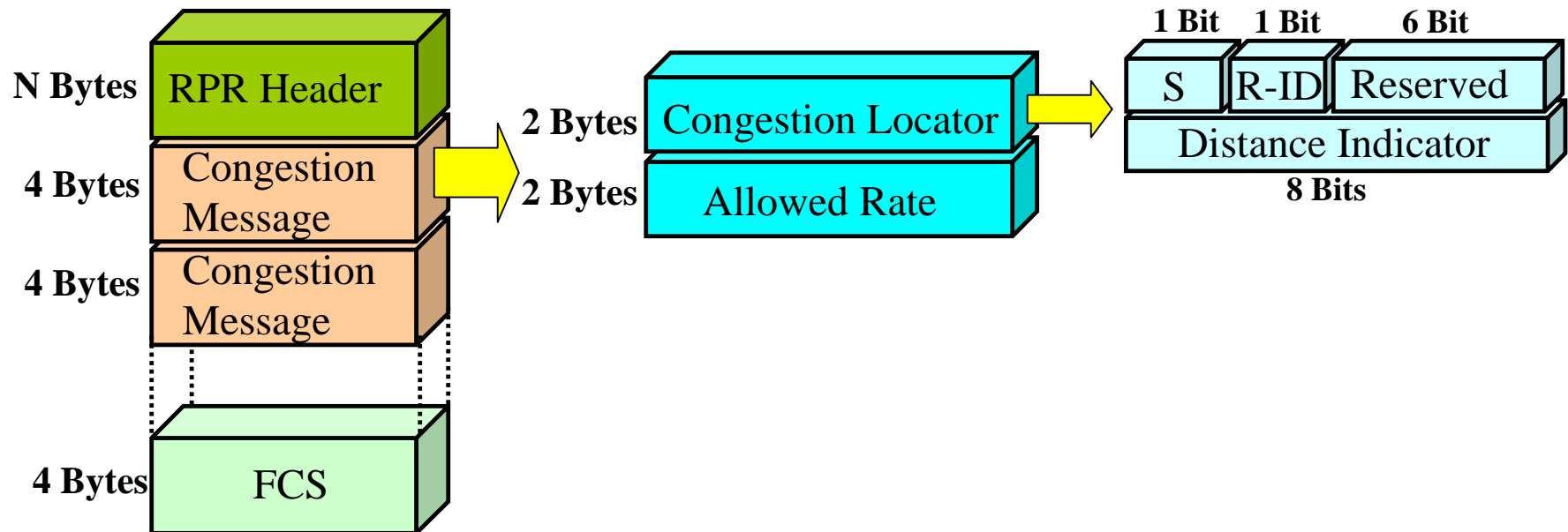



Congestion Message Frame (Cont.)

- Point to point (one hop) message
- Number of congestion messages in a frame equals to the number of congestion points in the ring
- Congestion message is 4 bytes length, it includes:
 - Congestion Locator, contains:
 - Stack bit – Indicates whether this message is the last in the packet
 - Ring Indicator – Indicates in which ringlet the congestion was detected
 - Relative Distance Indicator – Counts hops from the congested station
 - Allowed Rate – Indicates the maximum rate that each Station allowed to source through the congested link



Congestion Message Flow

Ring with one congestion point

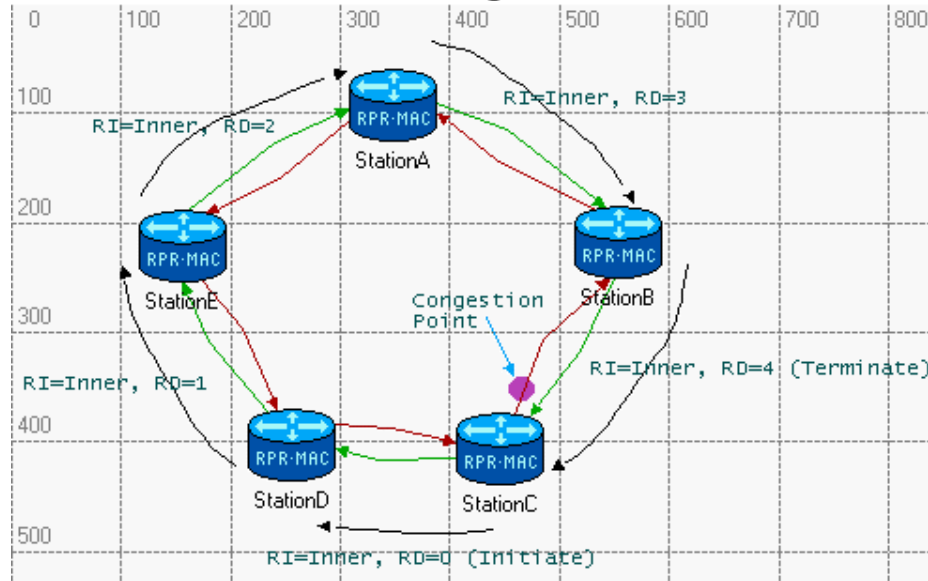

Ring with two congestion points

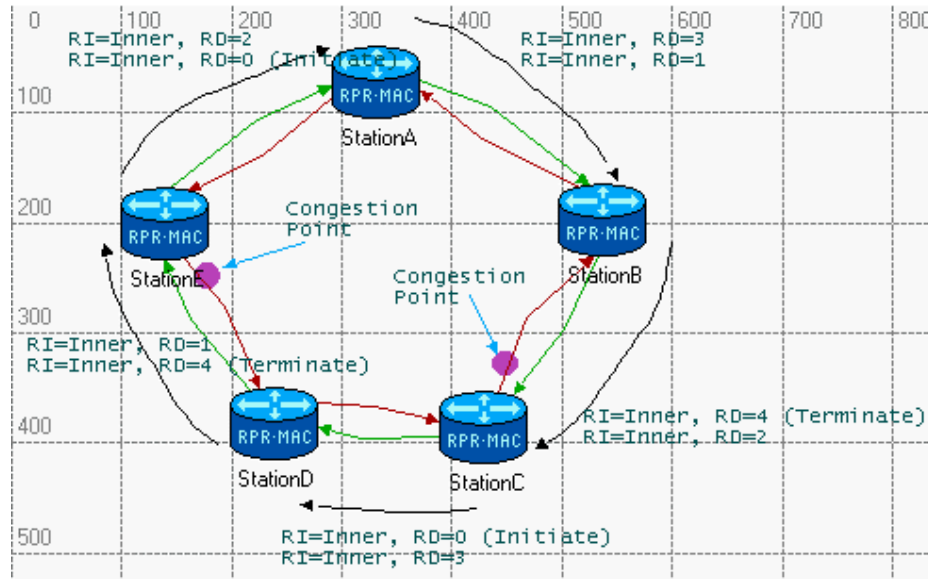



Conclusions

- VOQ improves fairness performance
 - Better utilization of the ring spans
 - Eliminates HOL blocking effects
 - Can be used in a ring with number of congestion points
- Stations with and without VOQ can co-exist on the same ring without affecting each other
- VOQ enables stations to operate on RPR ring with different links rate



Summary

- The RPR standard should define:
 - The following parameters
 - Congestion conditions detection time
 - Station response time to Congestion Message
 - The increase rate of transmitted bandwidth once the congestion is cleared
 - Bandwidth management protocol
 - Message format
 - Fields content
 - Allowed Rate granularity
 - Transmission frequency
 - Congestion Message updating rate



Summary (Cont.)

- The RPR standard should not specify:
 - The VOQ design
 - Number of VOQ
 - Congestion detection method
- The RPR standard should enable:
 - Stations with different VOQ implementation to coexist on the same ring with same bandwidth management protocol without impairing each other