

## **144. Multipoint MAC Control for 100G–EPON**

### **144.1 Overview**

#### **144.1.1 Goals and objectives**

#### **144.1.2 Position of Multipoint MAC Control within the IEEE 802.3 hierarchy**

#### **144.1.3 Functional block diagram**

#### **144.1.4 Service interfaces**

#### **144.1.5 State diagram conventions**

1  
2  
3  
4  
5  
6  
7  
8  
9  
10  
11  
12  
13  
14  
15  
16  
17  
18  
19  
20  
21  
22  
23  
24  
25  
26  
27  
28  
29  
30  
31  
32  
33  
34  
35  
36  
37  
38  
39  
40  
41  
42  
43  
44  
45  
46  
47  
48  
49  
50  
51  
52  
53  
54

## 144.1.6 State diagram conventions

The body of this standard comprises state diagrams, including the associated definitions of variables, constants, and functions. In case of any discrepancies between a state diagram and descriptive text, the state diagram prevails.

The notation used in the state diagrams follows the conventions of 21.5. State diagram timers follow the conventions of 14.2.3.2 augmented as follows:

- a) [start  $x\_timer$ ,  $y$ ] sets expiration of  $y$  to timer  $x\_timer$ .
- b) [stop  $x\_timer$ ] aborts the timer operation for  $x\_timer$  asserting  $x\_timer\_not\_done$  indefinitely.

The notation ++ after a counter indicates it is to be incremented by 1. The notation -- after a counter indicates it is to be decremented by 1. The notation -= after a counter indicates that the counter value is to be decremented by the following value. The notation += after a counter indicates that the counter value is to be incremented by the following value. Code examples given in this clause adhere to the style of the “C” programming language.

The state diagrams use an abbreviation MACR as a shorthand form for MA\_CONTROL.request, MACI as a shorthand form for MA\_CONTROL.indication, MADR as a shorthand for MA\_DATA.request, and MADI as a shorthand for MA\_DATA.indication primitives.

The vector notations used in the state diagrams for bit vector use 0 to mark the first received bit and so on (for example data<15:0>), following the conventions of 3.1 for bit ordering.

$a < b$ : A function that is used to compare two values. Returned value is true when  $b$  is larger than  $a$  allowing for wrap around of  $a$  and  $b$ . The comparison is made by subtracting  $b$  from  $a$  and testing the MSB. When  $MSB(a-b) = 1$  the value true is returned, else false is returned. In addition, the following functions are defined in terms of  $a < b$ :

- $a > b$  is equivalent to  $!(a < b \text{ or } a = b)$
- $a \geq b$  is equivalent to  $!(a < b)$
- $a \leq b$  is equivalent to  $!(a > b)$

## 144.2 Multipoint MAC Control operation

### 144.2.1 Principles of Multipoint MAC Control

### 144.2.2 Multipoint transmission control, Control Parser, and Control Multiplexer

## 144.3 Multipoint Control Protocol (MPCP)

### 144.3.1 Principles of Multipoint Control Protocol

### 144.3.2 Compatibility considerations

### 144.3.3 Discovery processing

Discovery is the process whereby newly connected or off-line ONUs are provided access to the PON. The process is driven by the OLT, which periodically makes available Discovery Windows during which off-line ONUs are given the opportunity to make themselves known to the OLT. The periodicity of these windows is unspecified and left up to the implementer. The OLT signifies that a discovery period is occurring by broadcasting a **DISCOVERY\_GATE** MPCPDU, which includes the starting time and length of the discovery window, along with the *Discovery Information* field, as defined in **77.3.6.1**. With the appropriate settings of individual flags contained in this 16 bit wide field, the OLT notifies all the ONUs about its upstream and downstream channel transmission capabilities. Note that the OLT may simultaneously support more than one data rate in the given transmission direction.

Off-line ONUs, upon receiving a **DISCOVERY\_GATE** MPCPDU, wait for the period to begin and then transmit a REGISTER\_REQ MPCPDU to the OLT. Discovery windows are unique in that they are the only times when multiple ONUs can access the PON simultaneously, and transmission overlap can occur. In order to reduce transmission overlaps, a contention algorithm is used by all ONUs. Measures are taken to reduce the probability for overlaps by artificially simulating a random distribution of distances from the OLT. Each ONU waits a random amount of time before transmitting the REGISTER\_REQ MPCPDU that is shorter than the length of the discovery window. Note that multiple valid REGISTER\_REQ MPCPDUs can be received by the OLT during a single discovery window. Included in the REGISTER\_REQ MPCPDU is the ONU's MAC address and number of maximum pending grants. Additionally, a registering ONU notifies the OLT of its transmission capabilities in the upstream and downstream channels by setting appropriately the flags in the Discovery Information field, as specified in **77.3.6.3**.

Note that even though a compliant ONU is not prohibited from supporting more than one data rate in any transmission channel, it is expected that a single supported data rate for upstream and downstream channel is indicated in the Discovery Information field. Moreover, in order to assure maximum utilization of the upstream channel and to decrease the required size of the guard band between individual data bursts, the registering ONU notifies the OLT of the laser on/off times, by setting appropriate values in the Laser On Time and Laser Off Time fields, where both values are expressed in the units of 1 EQ.

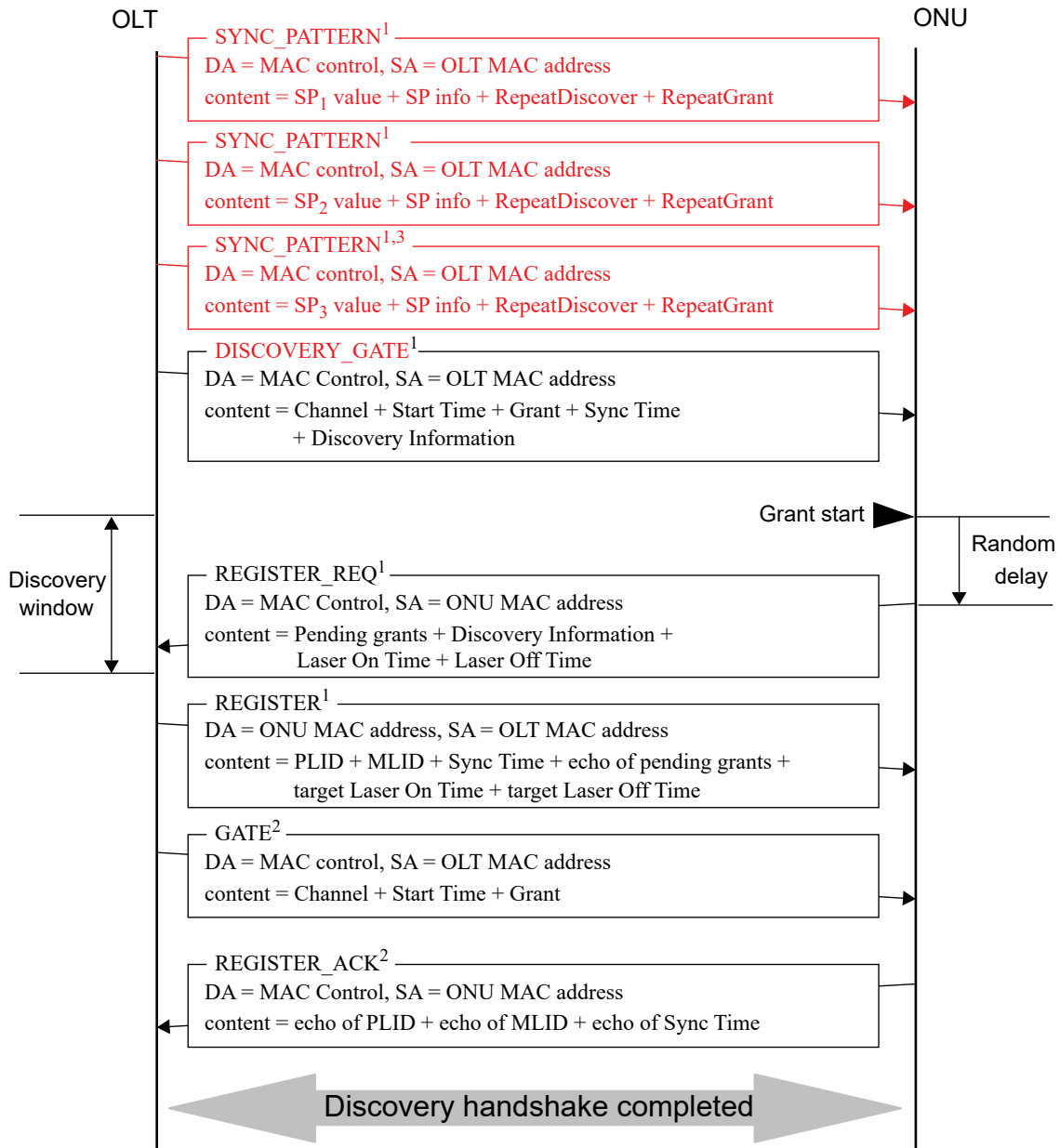
Upon receipt of a valid REGISTER\_REQ MPCPDU, the OLT registers the ONU, allocating and assigning a new port identity (LLID), and bonding a corresponding MAC to the LLID.

The next step in the process is for the OLT to transmit a REGISTER MPCPDU to the newly discovered ONU, which contains the ONU's LLID, and the OLT's required synchronization time. Moreover, the OLT echoes the maximum number of pending grants. The OLT also sends the target value of laser on time and laser off time, which may be different than laser on time and laser off time delivered by the ONU in the REGISTER\_REQ MPCPDU.

The OLT at that time has enough information to schedule the ONU for access to the PON and transmits a standard GATE MPCPDU allowing the ONU to transmit a REGISTER\_ACK MPCPDU. Upon receipt of the REGISTER\_ACK MPCPDU, the discovery process for that ONU is complete, the ONU is registered and normal message traffic can begin. It is the responsibility of Layer Management to perform the MAC bonding, and start transmission from/to the newly registered ONU. The discovery message exchange is illustrated in Figure 144–1.

There may exist situations when the OLT requires that an ONU go through the discovery sequence again and reregister. Similarly, there may be situations where an ONU needs to inform the OLT of its desire to deregister. The ONU can then reregister by going through the discovery sequence. For the OLT, the REGISTER MPCPDU may indicate a value, Reregister or Deregister, that if either is specified forces the receiving ONU into reregistering. For the ONU, the REGISTER\_REQ MPCPDU contains the Deregister bit that signifies to the OLT that this ONU needs to be deregistered.

The Discover process also includes announcement of the Sync Pattern (SP) structure using the SYNC\_PATTERN MPCPDU exchange between the OLT and the ONU. Two or three separate SYNC\_PATTERN MPCPDUs are sent by the OLT, announcing the value of SP<sub>1</sub>, SP<sub>2</sub>, and (if present) SP<sub>3</sub> portions of the Sync Pattern, together with the repeat count to be used during the Discovery Window and normal granting operation. This allows the OLT to effectively configure the Sync Pattern structure and optimize it for the specific OLT receiver implementation.

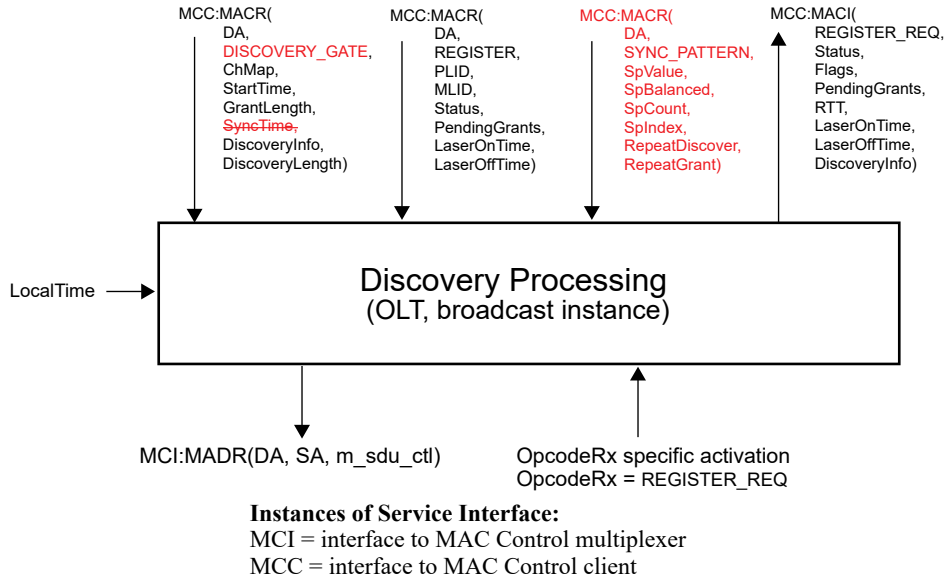


<sup>1</sup> Messages sent on a broadcast PLID

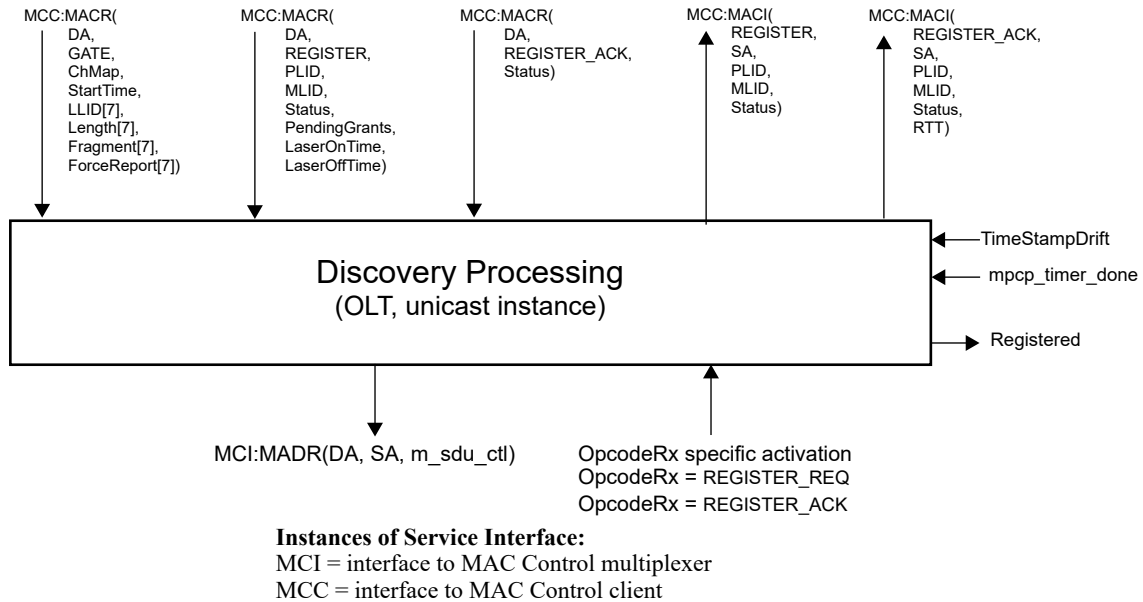
<sup>2</sup> Messages sent on unicast PLID

<sup>3</sup> Present only when SP Count in SYNC\_PATTERN MPCPDU is equal to 3

**Figure 144-1—Discovery handshake message exchange**

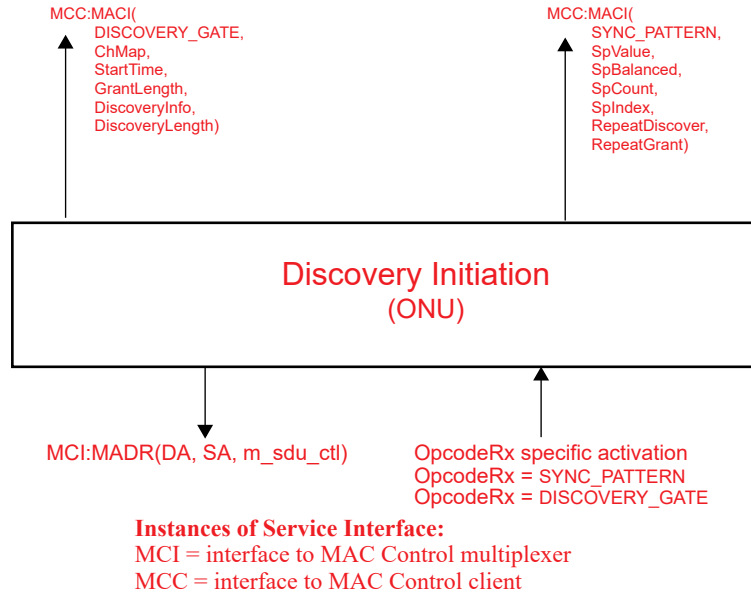


**Figure 144-2—Discovery Processing service interfaces (OLT, broadcast instance)**

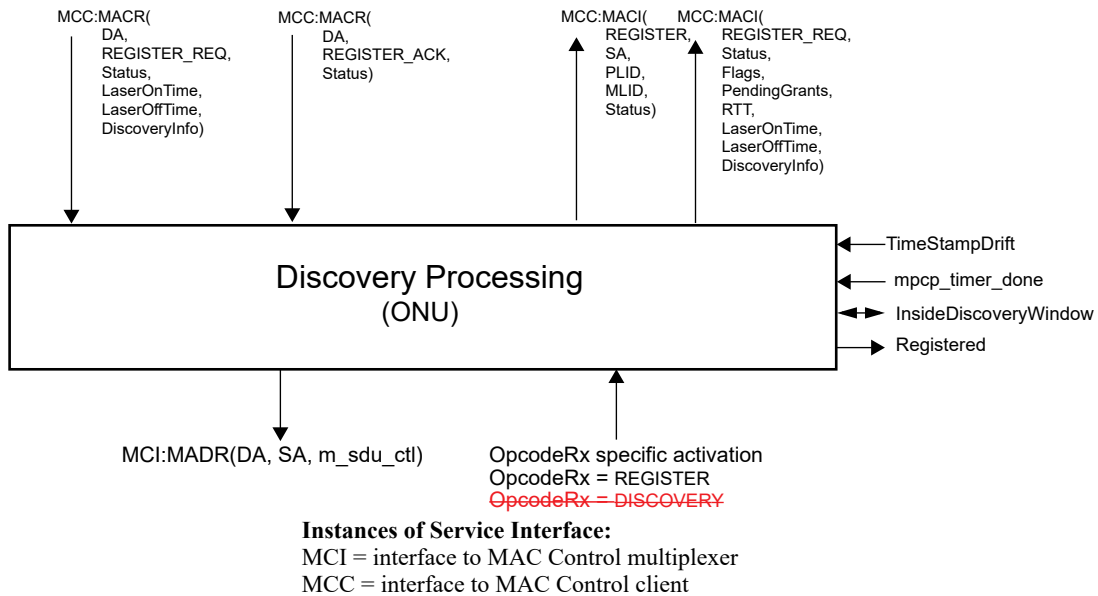


**Figure 144-3—Discovery Processing service interfaces (OLT, unicast instance)**

1  
2  
3  
4  
5  
6  
7  
8  
9  
10  
11  
12  
13  
14  
15  
16  
17  
18  
19  
20  
21  
22  
23  
24  
25  
26  
27  
28  
29  
30  
31  
32  
33  
34  
35  
36  
37  
38  
39  
40  
41  
42  
43  
44  
45  
46  
47  
48  
49  
50  
51  
52  
53  
54



**Figure 144-4—Discovery Processing service interfaces (ONU)**



**Figure 144-5—Discovery Processing service interfaces (ONU)**

**144.3.3.1 Constants**

**LaserOffTimeCapability**

TYPE: 8-bit unsigned

This constant represents the time required to terminate the laser, in the units of 1 EQ. While the default value corresponds to a maximum allowed  $T_{off}$  (as specified in [Table 75-8](#) and [Table 75-9](#)), implementations may set it to the actual value time period required for turning off the PMD, as specified in [75.7.14](#).

VALUE: 0xC8 (512 ns, default value)

LaserOnTimeCapability

TYPE: 8-bit unsigned

This constant represents the time required to initialize the laser, in the units of 1 EQ. While the default value corresponds to a maximum allowed  $T_{on}$  (as specified in Table 75–8 and Table 75–9), implementations may set it to the actual value time period required for turning on the PMD, as specified in 75.7.14.

VALUE: 0xC8 (512 ns, default value)

**144.3.3.2 Variables**

BEGIN

This variable is defined in 144.2.2.3.

DataRx

This variable is defined in 144.2.2.3.

DataTx

This variable is defined in 144.2.2.3.

GrantEndTime

TYPE: 32-bit unsigned

This variable holds the time at which the OLT expects the ONU grant to complete. Failure of a REGISTER\_ACK message from an ONU to arrive at the OLT before *GrantEndTime* is a fatal error in the discovery process, and causes registration to fail for the specified ONU, who may then retry to register. The value of *GrantEndTime* is expressed in the units of 1 EQ.

InsideDiscoveryWindow

TYPE: Boolean

This variable holds the current status of the discovery window. It is set to true when the discovery window opens, and is set to false when the discovery window closes.

LaserOffTime

TYPE: 8-bit unsigned

This variable holds the time required to terminate the laser and counts the time period required for turning off the PMD, as specified by the value of  $T_{off}$  in 75.7.14, expressed in the units of 1 EQ.

VALUE: LaserOffTimeCapability (default value)

LaserOnTime

TYPE: 8-bit unsigned

This variable holds the time required to initiate the PMD and counts the time period required for turning on the PMD, as specified by the value of  $T_{on}$  in 75.7.14, expressed in the units of 1 EQ.

VALUE: LaserOnTimeCapability (default value)

LocalTime

This variable is defined in 144.2.2.2.

m\_sdu\_ctl

This variable is defined in 144.2.2.3.

OpcodeRx

This variable is defined in 144.2.2.3.

1  
2  
3  
4  
5  
6  
7  
8  
9  
10  
11  
12  
13  
14  
15  
16  
17  
18  
19  
20  
21  
22  
23  
24  
25  
26  
27  
28  
29  
30  
31  
32  
33  
34  
35  
36  
37  
38  
39  
40  
41  
42  
43  
44  
45  
46  
47  
48  
49  
50  
51  
52  
53  
54

PendingGrants	1
TYPE: 16-bit unsigned	2
This variable holds the maximum number of pending grants that an ONU is able to queue.	3
	4
Registered	5
TYPE: Boolean	6
This variable holds the current result of the Discovery Process. It is set to true once the discovery process is complete and registration is acknowledged.	7
	8
	9
RepeatDiscover	10
TYPE: 16-bit unsigned	11
This variable indicates how many times the given Sync Pattern element (SP <sub>1</sub> , SP <sub>2</sub> , or SP <sub>3</sub> ) is transmitted during the Discovery Window. The supported values range from 0 to 2 <sup>16</sup> -1.	12
	13
	14
RepeatGrant	15
TYPE: 16-bit unsigned	16
This variable indicates how many times the given Sync Pattern element (SP <sub>1</sub> , SP <sub>2</sub> , or SP <sub>3</sub> ) is transmitted during the regular granting operation. The supported values range from 0 to 2 <sup>16</sup> -1.	17
	18
	19
SpBalanced	20
TYPE: Boolean	21
This variable indicates whether the Sync Pattern element carried in the <i>SpValue</i> variable is expected to be transmitted in the balanced fashion (when set to True) or not (when set to False). Details about the balanced and unbalanced Sync Pattern element transmission are covered in <TBD, likely PCS Clause>.	22
	23
	24
	25
	26
	27
SpCount	28
TYPE: 2-bit unsigned integer	29
This variable indicates how many Sync Pattern elements are announced by the OLT in the SYNC_PATTERN MPCPDU sequence. Two values are possible, i.e., 2 or 3, depending on whether the AGC and CDR Sync Pattern elements are defined separately or not. Details about individual Sync Pattern elements, their number, and meaning are covered in <TBD, likely PCS Clause>.	30
	31
	32
	33
	34
SpIndex	35
TYPE: 2-bit unsigned	36
This variable indicates the number of the Sync Pattern element announced by the OLT in the SYNC_PATTERN MPCPDU. The <i>SpIndex</i> values are 0-based and may have values up to <i>SpCount</i> - 1, i.e., for <i>SpCount</i> = 2, <i>SpIndex</i> may have values of 0 or 1, and for <i>SpCount</i> = 3, <i>SpIndex</i> may have values of 0, 1, or 2. Details about individual Sync Pattern elements, their number, and meaning are covered in <TBD, likely PCS Clause>.	37
	38
	39
	40
	41
	42
SpIndexVector	43
TYPE: Vector of 2-bit unsigned integer	44
This vector stores values of <i>SpIndex</i> variables received by the ONU since the last reset of this vector. Individual values stored in this vector are sorted in an increasing order.	45
	46
	47
SpValue	48
TYPE: 257-bit unsigned integer	49
This variable holds the value of the Sync Pattern element (SP <sub>1</sub> , SP <sub>2</sub> , or SP <sub>3</sub> ), mapped from the <i>SpValue</i> field in the SYNC_PATTERN MPCPDU.	50
	51
	52
TimeStampDrift	53
This variable is defined in 144.2.2.3.	54



### 144.3.3.3 Functions

#### PushSpIndex ( *IndexValue* )

This function inserts a new *SpIndex* value (represented by the *IndexValue* variable) into the *SpIndexVector*, sorting all values in an increasing order.

#### ClearSpIndex ()

This function clears the content of the *SpIndexVector* and sets its size to zero.

#### IsSpIndexVectorFull ()

This function verifies whether the given *SpIndexVector* is full, i.e., contains all *SpIndex* values of 0, ... *SpCount* - 1, and the size of *SpIndexVector* is equal to *SpCount*. A return value of True indicates that the *SpIndexVector* contains all expected *SpIndex* values. The value of False is returned otherwise.

### 144.3.3.4 Timers

#### discovery\_window\_size\_timer

This timer is used to wait for the event signaling the end of the discovery window.

VALUE: The timer value is set dynamically based on the parameters received in a **DISCOVERY\_GATE** message.

#### mcp\_timer

This timer is used to measure the arrival rate of MPCP frames in the link. Failure to receive frames is considered a fatal fault and leads to deregistration.

### 144.3.3.5 Messages

#### MAC:MADI(DA, SA, m\_sdu, receiveStatus)

The service primitive is defined in 2.3.2.

#### MAC:MADR (DA, SA, m\_sdu)

The service primitive is defined in 2.3.2.

#### MCC:MACR(DA, SYNC\_PATTERN, SpValue, SpBalanced, SpCount, SpIndex, RepeatDiscover, RepeatGrant)

This service primitive is used by the MAC Control client at the OLT to initiate the transmission of Sync Pattern element configuration information to ONUs. This primitive accepts the following parameters:

DA: Multicast MAC address.

SYNC\_PATTERN: Opcode for SYNC\_PATTERN MPCPDU as defined in Table 31A-1.

SpValue: A 257-bit value representing a portion of the Sync Pattern (SP1, SP2 or SP3, as indicated by *SpIndex* parameter), where bits 1 through 256 are mapped into the *Sync Pattern (SP)* field in the SYNC\_PATTERN MPCPDU, and bit 0 is mapped into bit 15 the *SP Info* field in the SYNC\_PATTERN MPCPDU.

SpBalanced: A Boolean value indicating whether the given Sync Pattern element carried in the *SpValue* parameter is to be transmitted in a balanced manner (when set to *true*) or not (when set to *false*). This parameter maps into bit 7 in the *SP Info* field in the SYNC\_PATTERN MPCPDU.

SpCount:	A value indicating the number of Sync Pattern elements that are configured by the OLT on the ONU. This parameter maps into bits 3-4 in the <i>SP Info</i> field in the SYNC_PATTERN MPCPDU.	1 2 3 4
SpIndex:	A value indicating the number of the Sync Pattern element being configured by the OLT on the ONU. This parameter maps into bits 0-1 in the <i>SP Info</i> field in the SYNC_PATTERN MPCPDU.	5 6 7 8
RepeatDiscover:	A value indicating the number of times the given Sync Pattern element is repeated when used during the Discovery Window. This parameter corresponds to the <i>RepeatDiscover</i> field in the SYNC_PATTERN MPCPDU.	9 10 11 12
RepeatGrant:	A value indicating the number of times the given Sync Pattern element is repeated when used outside the Discovery Window. This parameter corresponds to the <i>RepeatGrant</i> field in the SYNC_PATTERN MPCPDU.	13 14 15 16 17
MCC:MACI(SYNC_PATTERN, SpValue, SpBalanced, SpCount, SpIndex, RepeatDiscover, RepeatGrant)		18 19
This service primitive is used by the MAC Control client at the OLT to initiate the transmission of Sync Pattern element configuration information to ONUs. This primitive accepts the following parameters:		20 21 22
SYNC_PATTERN:	Opcode for SYNC_PATTERN MPCPDU as defined in Table 31A-1.	23 24
SpValue:	A 257-bit value representing a portion of the Sync Pattern (SP1, SP2 or SP3, as indicated by <i>SpIndex</i> parameter), where bits 1 through 256 are mapped from the <i>Sync Pattern (SP)</i> field in the SYNC_PATTERN MPCPDU, and bit 0 is mapped from bit 15 the <i>SP Info</i> field in the SYNC_PATTERN MPCPDU.	25 26 27 28 29
SpBalanced:	A Boolean value indicating whether the given Sync Pattern element carried in the <i>SpValue</i> parameter is to be transmitted in a balanced manner (when set to <i>true</i> ) or not (when set to <i>false</i> ). This parameter maps from bit 7 in the <i>SP Info</i> field in the SYNC_PATTERN MPCPDU.	30 31 32 33 34
SpCount:	A value indicating the number of Sync Pattern elements that are configured by the OLT on the ONU. This parameter maps from bits 3-4 in the <i>SP Info</i> field in the SYNC_PATTERN MPCPDU.	35 36 37 38
SpIndex:	A value indicating the number of the Sync Pattern element being configured by the OLT on the ONU. This parameter maps from bits 0-1 in <i>SP Info</i> field in the SYNC_PATTERN MPCPDU.	39 40 41 42
RepeatDiscover:	A value indicating the number of times the given Sync Pattern element is repeated when used during the Discovery Window. This parameter corresponds to the <i>RepeatDiscover</i> field in the SYNC_PATTERN MPCPDU.	43 44 45 46
RepeatGrant:	A value indicating the number of times the given Sync Pattern element is repeated when used outside the Discovery Window. This parameter corresponds to the <i>RepeatGrant</i> field in the SYNC_PATTERN MPCPDU.	47 48 49 50 51 52 53 54

MCC:MACR(DA, **DISCOVERY\_GATE**, ChMap, StartTime, GrantLength, **SyncTime**,  
DiscoveryInfo, DiscoveryLength)

The service primitive is used by the MAC Control client at the OLT to initiate the Discovery Process. This primitive accepts the following parameters:

- DA: Multicast or unicast MAC address.
- DISCOVERY\_GATE**: Opcode for **DISCOVERY\_GATE** MPCPDU as defined in Table 31A-1.
- ChMap: A bitmap representing the wavelength channel(s) on which to transmit on during the assigned transmission slot. See Table 144-1 for details.
- StartTime: Start time of the discovery window.
- GrantLength: Length of the grant given for discovery.
- ~~SyncTime~~: ~~The time interval required to stabilize the receiver at the OLT.~~
- DiscoveryInfo: This parameter represents the Discovery Information field in **DISCOVERY\_GATE** MPCPDU as specified in 144.3.7.6, defining the speed(s) the OLT is capable of receiving and speed(s) at which the discovery window is opened for.
- DiscoveryLength: Length of the discovery window process.

MCC:MACI(**DISCOVERY\_GATE**, ChMap, StartTime, GrantLength, DiscoveryInfo,  
DiscoveryLength)

The service primitive is used by the Discovery Initiation process at the ONU to notify the client and Layer Management about the arrival of a DISCOVER GATE MPCPDU. This primitive accepts the following parameters:

- DISCOVERY\_GATE**: Opcode for **DISCOVERY\_GATE** MPCPDU as defined in Table 31A-1.
- ChMap: A bitmap representing the wavelength channel(s) on which to transmit on during the assigned transmission slot. See Table 144-1 for details.
- StartTime: Start time of the discovery window.
- GrantLength: Length of the grant given for discovery.
- DiscoveryInfo: This parameter represents the Discovery Information field in **DISCOVERY\_GATE** MPCPDU as specified in 144.3.7.6, defining the speed(s) the OLT is capable of receiving and speed(s) at which the discovery window is opened for.
- DiscoveryLength: Length of the discovery window process.

MCC:MACR(DA, GATE, ChMap, StartTime, LLID[7], Length[7], Fragment[7],  
ForceReport[7])

This service primitive is used by the MAC Control client at the OLT to issue the GATE message to an ONU. This primitive accepts the following parameters:

- DA: Multicast MAC Control address as defined in Annex 31B.
- GATE: Opcode for GATE MPCPDU as defined in Table 31A-1.
- ChMap: A bitmap representing the wavelength channel(s) on which to transmit on during the assigned transmission slot. See Table 144-1 for details.
- StartTime: Represents the start time of the transmission grant. The start time is compared to the local clock, to correlate the start of the grant.
- LLID[7]: Represents the logical link that is being granted a transmission slot. Only elements *j* with non-zero value in associated *Length[j]* field of the array are used.

Length[7]:	Lengths of the individual grants. Only elements <i>j</i> with non-zero value in <i>Length[j]</i> field of the array are used.	1
Fragment[7]:	Flags indicating whether fragmentation is allowed within the given grant. Only elements <i>j</i> with non-zero value in associated <i>Length[j]</i> field of the array are used.	2
ForceReport[7]:	Flags indicating whether a REPORT message should be generated in the corresponding grant. Only elements <i>j</i> with non-zero value in associated <i>Length[j]</i> field of the array are used.	3
		4
		5
		6
		7
		8
		9
MCC:MACR(DA, REGISTER_REQ, Status, LaserOnTime, LaserOffTime, DiscoveryInfo)		10
	The service primitive is used by a client at the ONU to request the Discovery Process to perform a registration. This primitive accepts the following parameters:	11
		12
DA:	Multicast MAC Control address as defined in Annex 31B.	13
REGISTER_REQ:	opcode for REGISTER_REQ MPCPDU as defined in Table 31A-1.	14
Status:	This parameter takes on the indication supplied by the flags field in the REGISTER_REQ MPCPDU as defined in Table 144-2.	15
LaserOnTime:	This parameter holds the LaserOnTime value, expressed in the units of 1 EQ, as reported by MAC client and specified in 77.3.6.3.	16
LaserOffTime:	This parameter holds the LaserOffTime value, expressed in the units of 1 EQ, as reported by MAC client and specified in 77.3.6.3.	17
DiscoveryInfo:	This parameter represents the Discovery Information field, as specified in 77.3.6.3, defining the speed(s) the ONU is capable of transmitting and speed(s) at which the registration attempt is made.	18
		19
		20
		21
		22
		23
		24
		25
		26
		27
		28
		29
		30
MCC:MACI(REGISTER_REQ, Status, Flags, PendingGrants, RTT, LaserOnTime, LaserOffTime, DiscoveryInfo)		31
	The service primitive is issued by the Discovery Process to notify the client and Layer Management that the registration process is in progress. This primitive accepts the following parameters:	32
		33
REGISTER_REQ:	Opcode for REGISTER_REQ MPCPDU as defined in Table 31A-1.	34
Status:	This parameter holds one of the following values: <i>incoming</i> or <i>retry</i> . Value <i>incoming</i> is used at the OLT to signal that a REGISTER_REQ message was received successfully. The value <i>retry</i> is used at the ONU to signal to the client that a registration attempt failed and needs to be repeated.	35
Flags:	This parameter holds the contents of the <i>Flags</i> field in the REGISTER_REQ message. This parameter holds a valid value only when the primitive is generated by the Discovery Process in the OLT.	36
PendingGrants:	This parameter holds the contents of the <i>Pending Grants</i> field in the REGISTER_REQ message. This parameter holds a valid value only when the primitive is generated by the Discovery Process in the OLT.	37
RTT:	The measured round trip time to/from the ONU is returned in this parameter. RTT is expressed in the units of 1 EQ. This parameter holds a valid value only when the primitive is generated by the Discovery Process in the OLT.	38
		39
		40
		41
		42
		43
		44
		45
		46
		47
		48
		49
		50
		51
		52
		53
		54

LaserOnTime:	This parameter holds the contents of the <i>Laser On Time</i> field in the REGISTER_REQ message. This parameter holds a valid value only when the primitive is generated by the Discovery Process in the OLT.	1 2 3 4
LaserOffTime:	This parameter holds the contents of the <i>Laser Off Time</i> field in the REGISTER_REQ message. This parameter holds a valid value only when the primitive is generated by the Discovery Process in the OLT.	5 6 7 8
DiscoveryInfo:	This parameter holds the contents of the <i>Discovery Information</i> field in the REGISTER_REQ MPCPDU. This parameter holds a valid value only when the primitive is generated by the Discovery process in the OLT.	9 10 11 12 13
MCC:MACR(DA, REGISTER, PLID, MLID, Status, PendingGrants, LaserOnTime, LaserOffTime)		14 15
The service primitive is used by the MAC Control client at the OLT to initiate acceptance of an ONU. This primitive accepts the following parameters:		16 17
DA:	Unicast MAC address or multicast MAC Control address as defined in Annex 31B.	18 19
REGISTER:	Opcode for REGISTER MPCPDU as defined in Table 31A–1.	20
PLID:	This parameter holds the logical link identification number assigned by the MAC Control client to the PLID.	21 22
MLID:	This parameter holds the logical link identification number assigned by the MAC Control client to the MLID.	23 24
Status:	This parameter takes on the indication supplied by the <i>Flags</i> field in the REGISTER MPCPDU as defined in Table 144–4.	25 26
PendingGrants:	This parameters echoes back the <i>Echoed Pending Grants</i> field that was previously received in the REGISTER_REQ message.	27 28 29
LaserOnTime:	This parameter carries the target value of Laser On Time for the given ONU transmitter. This value may be different than the LaserOnTime value carried in the REGISTER_REQ MPCPDU received from the corresponding ONU MAC during Discovery stage.	30 31 32 33 34
LaserOffTime:	This parameter carries the target value of Laser Off Time for the given ONU transmitter. This value may be different than the LaserOffTime value carried in the REGISTER_REQ MPCPDU received from the corresponding ONU MAC during Discovery stage.	35 36 37 38 39 40
MCC:MACI(REGISTER, SA, PLID, MLID, Status)		41
This service primitive is issued by the Discovery Process at the OLT or an ONU to notify the MAC Control client and Layer Management of the result of the change in registration status. This primitive accepts the following parameters:		42 43 44
REGISTER:	Opcode for REGISTER MPCPDU as defined in Table 31A–1.	45
SA:	This parameter represents the MAC address of the OLT.	46
PLID:	This parameter holds the logical link identification number assigned by the MAC Control client to the PLID.	47 48
MLID:	This parameter holds the logical link identification number assigned by the MAC Control client to the MLID.	49 50
Status:	This parameter holds one of the following values: <i>accepted / denied / deregistered / reregistered</i> .	51 52 53 54

MCC:MACR(DA, REGISTER\_ACK, Status)

This service primitive is issued by the MAC Control clients at the ONU and the OLT to acknowledge the registration. This primitive accepts the following parameters:

- DA: Multicast MAC Control address as defined in Annex 31B.
- REGISTER\_ACK: Opcode for REGISTER\_ACK MPCPDU as defined in Table 31A-1.
- Status: This parameter takes on the indication supplied by the *Flags* field in the REGISTER\_ACK MPCPDU as defined in Table 144-5.

MCC:MACI(REGISTER\_ACK, SA, PLID, MLID, Status, RTT)

This service primitive is issued by the Discovery Process at the OLT to notify the client and Layer Management that the registration process has completed. This primitive accepts the following parameters:

- REGISTER\_ACK: Opcode for REGISTER\_ACK MPCPDU as defined in Table 31A-1.
- SA: This parameter represents the MAC address of the reciprocating device (ONU address at the OLT, and OLT address at the ONU).
- PLID: This parameter holds the logical link identification number assigned by the MAC Control client to the PLID.
- MLID: This parameter holds the logical link identification number assigned by the MAC Control client to the MLID.
- Status: This parameter holds one of the following values: *accepted / denied / reset / deregistered*.
- RTT: The measured round trip time to/from the ONU is returned in this parameter. RTT is expressed in the units of 1 EQ. This parameter holds a valid value only when the invoking Discovery Process in the OLT.

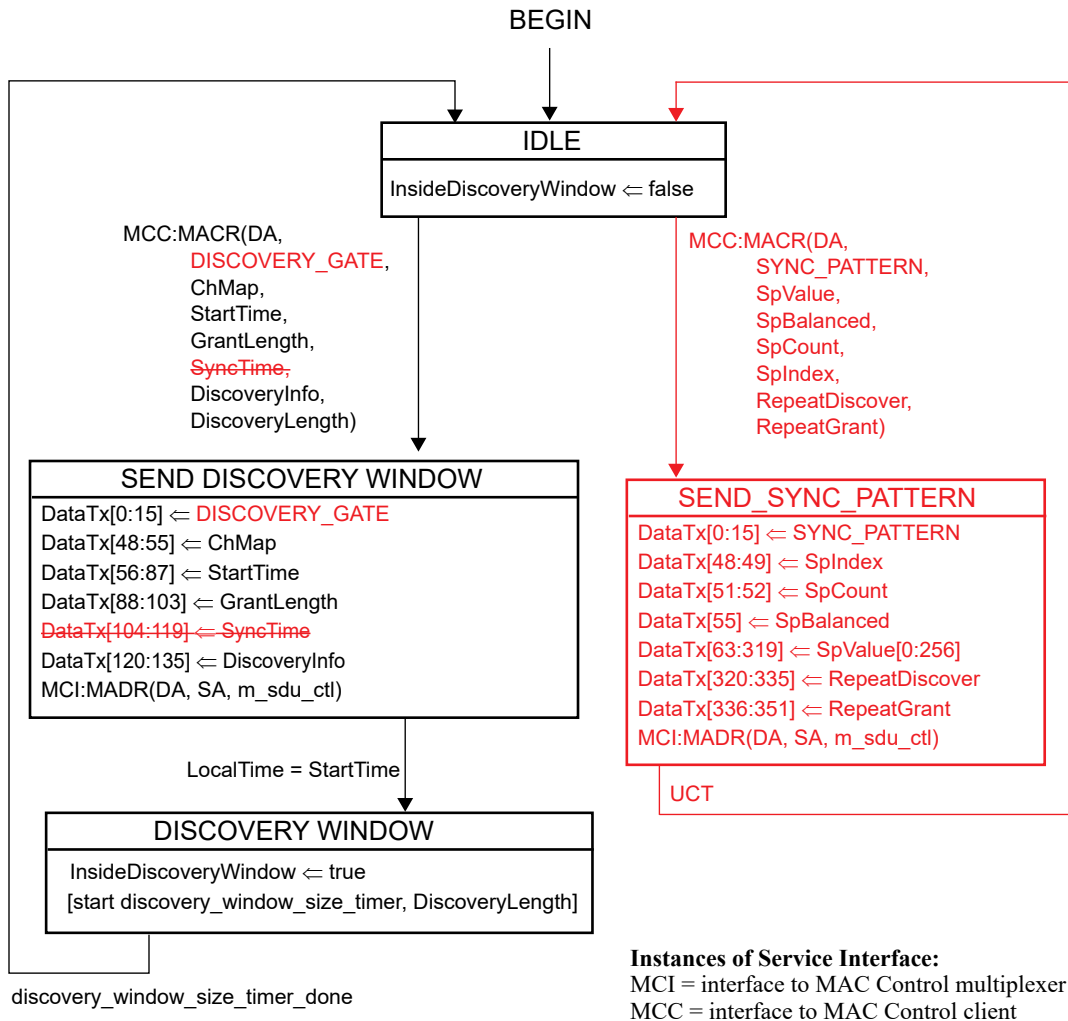
OpcodeSpecificFunction(Opcode)

Functions exported from opcode specific blocks that are invoked on the arrival of a MAC Control message of the appropriate opcode.

### 144.3.3.6 State Diagrams

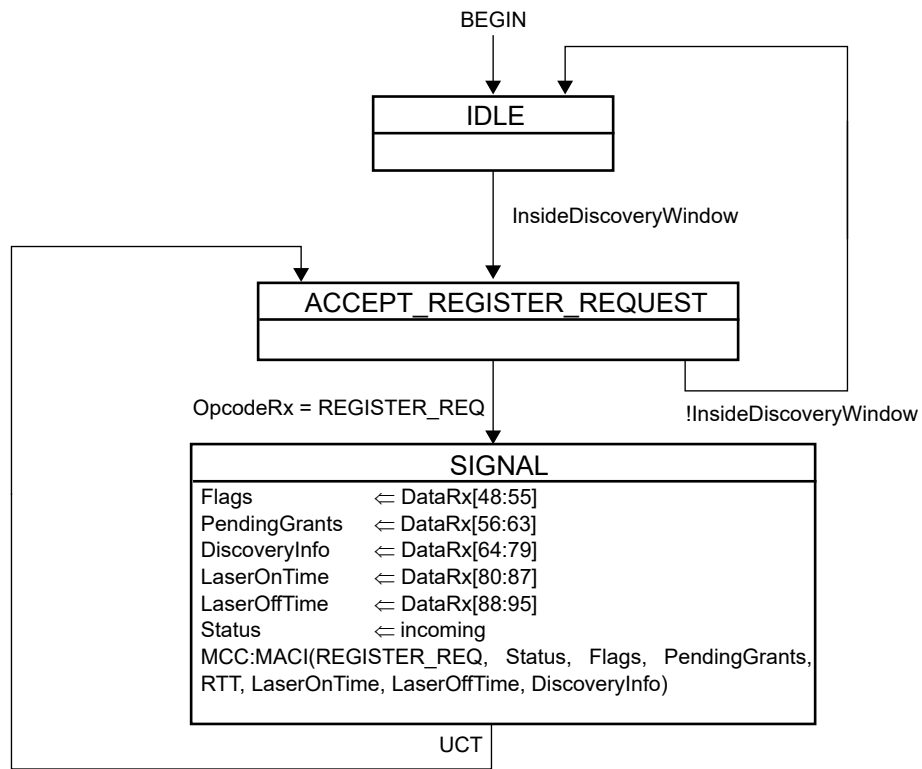
The Discovery Process in the OLT shall implement the Discovery Window Setup state diagram shown in Figure 144-6, Discovery Request Processing state diagram as shown in Figure 144-7, Register Processing state diagram as shown in Figure 144-8, and Final Registration state diagram as shown in Figure 144-9. The discovery process in the ONU shall implement the registration state diagram as shown in Figure 144-10 and Figure 144-11.

Instantiation of state diagrams as described in Figure 144-6, Figure 144-7, and Figure 144-8 is performed only at the Multipoint MAC Control instances attached to the broadcast LLID (0x7FFE). Instantiation of state diagrams as described in Figure 144-9 and Figure 144-11 is performed for every Multipoint MAC Control instance attached to a MAC associated with PLID, except the instance attached to the broadcast channel.



**Figure 144-6—Discovery Processing OLT Window Setup state diagram**

1  
2  
3  
4  
5  
6  
7  
8  
9  
10  
11  
12  
13  
14  
15  
16  
17  
18  
19  
20  
21  
22  
23  
24  
25  
26  
27  
28  
29  
30  
31  
32  
33  
34  
35  
36  
37  
38  
39  
40  
41  
42  
43  
44  
45  
46  
47  
48  
49  
50  
51  
52  
53  
54



**Instances of Service Interface:**

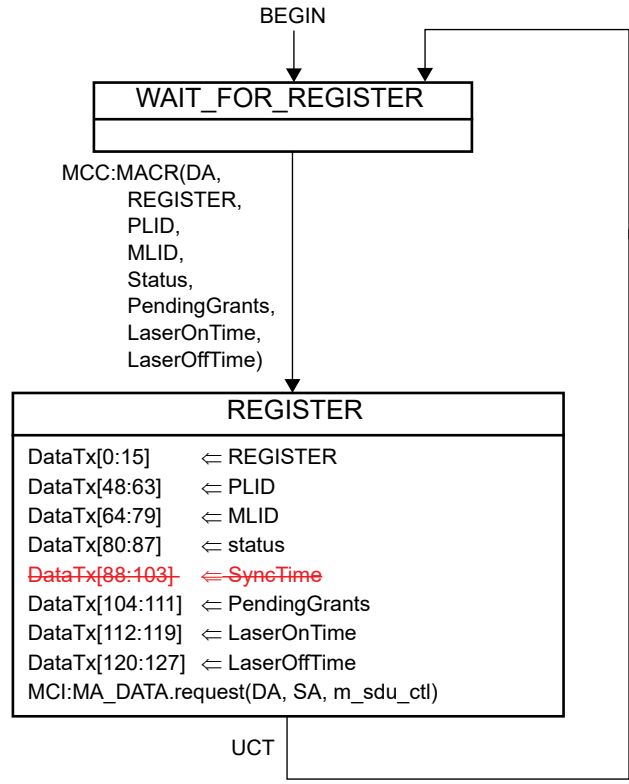
MCI = interface to MAC Control multiplexer

MCC = interface to MAC Control client

**Figure 144–7—Discovery Processing OLT Process Requests state diagram**

1  
2  
3  
4  
5  
6  
7  
8  
9  
10  
11  
12  
13  
14  
15  
16  
17  
18  
19  
20  
21  
22  
23  
24  
25  
26  
27  
28  
29  
30  
31  
32  
33  
34  
35  
36  
37  
38  
39  
40  
41  
42  
43  
44  
45  
46  
47  
48  
49  
50  
51  
52  
53  
54



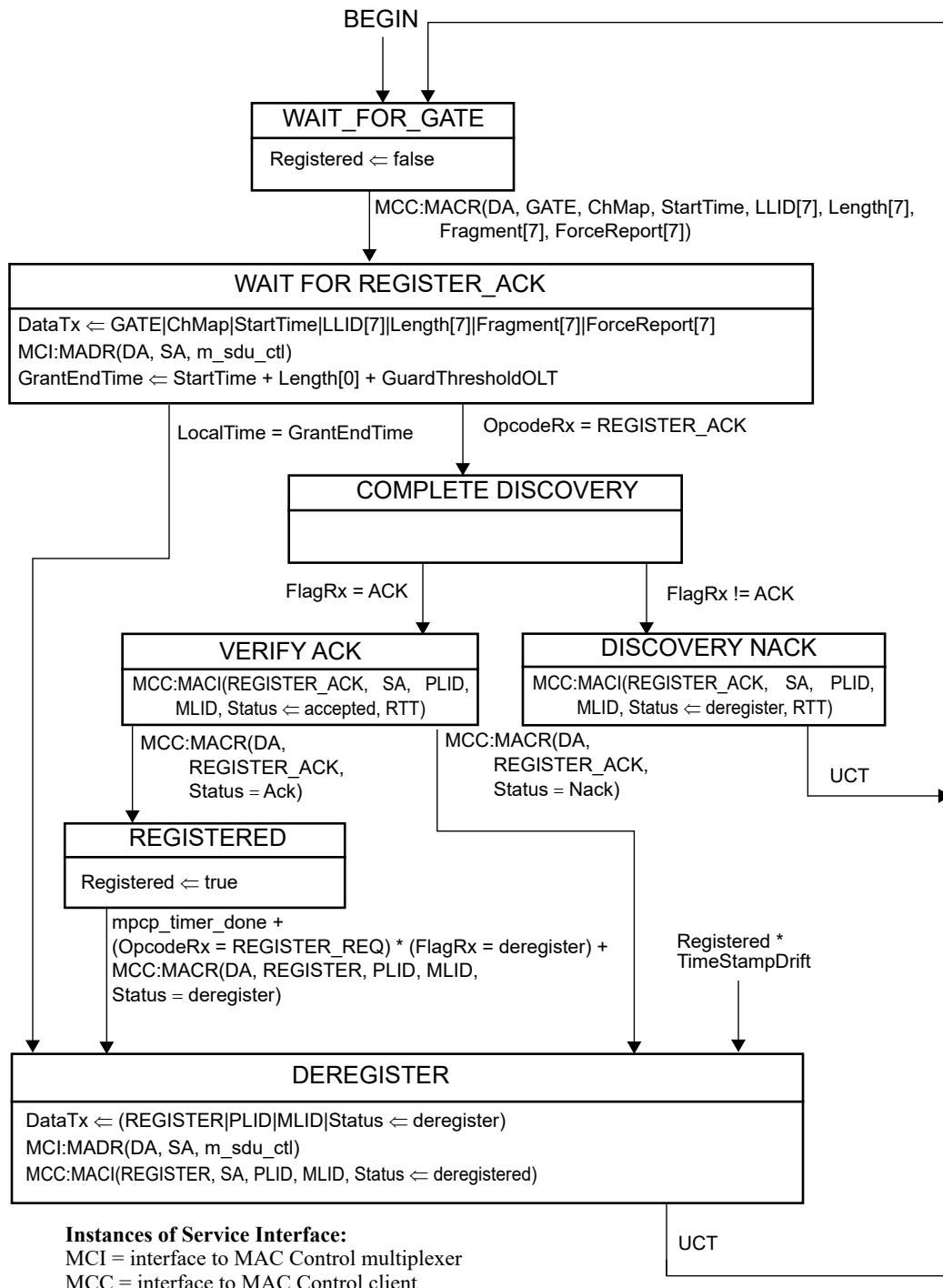


**Instances of Service Interface:**

MCI = interface to MAC Control multiplexer  
 MCC = interface to MAC Control client

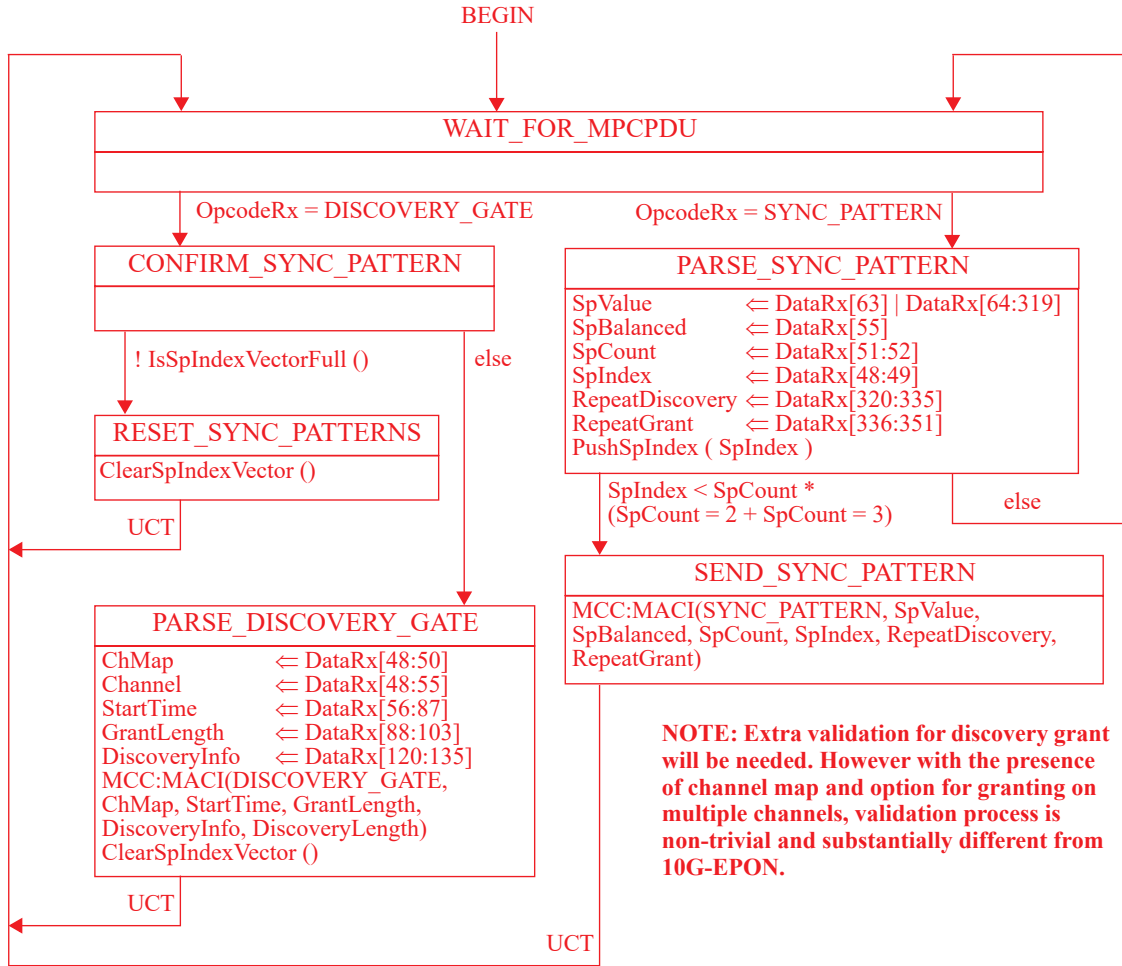
**Figure 144–8—Discovery Processing OLT Register state diagram**

1  
2  
3  
4  
5  
6  
7  
8  
9  
10  
11  
12  
13  
14  
15  
16  
17  
18  
19  
20  
21  
22  
23  
24  
25  
26  
27  
28  
29  
30  
31  
32  
33  
34  
35  
36  
37  
38  
39  
40  
41  
42  
43  
44  
45  
46  
47  
48  
49  
50  
51  
52  
53  
54



NOTE—The MAC Control Client issues the grant following the REGISTER MPCPDU, taking the ONU processing delay of REGISTER MPCPDU into consideration.

**Figure 144-9—Discovery Processing OLT Final Registration state diagram**



**Instances of Service Interface:**  
 MCC = interface to MAC Control client

**Figure 144–10—Discovery Initiation ONU state diagram**

**NOTE: Extra validation for discovery grant will be needed. However with the presence of channel map and option for granting on multiple channels, validation process is non-trivial and substantially different from 10G-EPON.**

1  
2  
3  
4  
5  
6  
7  
8  
9  
10  
11  
12  
13  
14  
15  
16  
17  
18  
19  
20  
21  
22  
23  
24  
25  
26  
27  
28  
29  
30  
31  
32  
33  
34  
35  
36  
37  
38  
39  
40  
41  
42  
43  
44  
45  
46  
47  
48  
49  
50  
51  
52  
53  
54

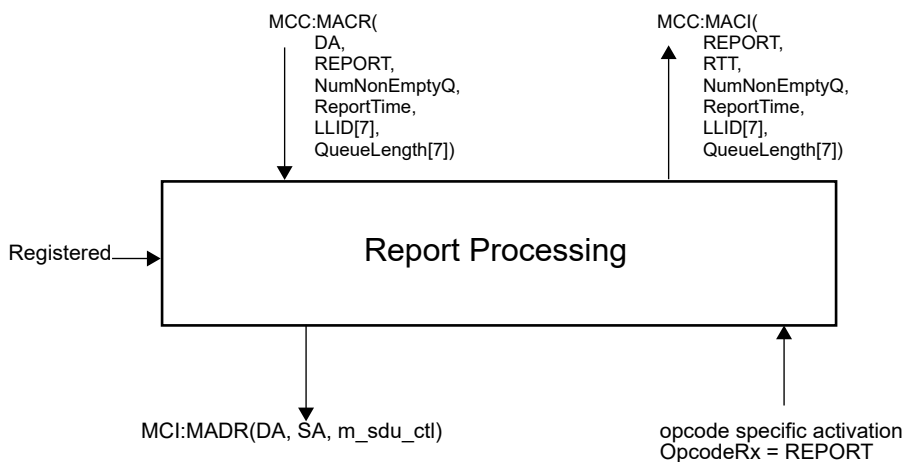


### 144.3.4 Report Processing

The Report Processing functional block has the responsibility of dealing with queue report generation and termination in the network. Reports are generated by higher layers and passed to the MAC Control sublayer by MAC Control clients. Status reports are used to signal bandwidth needs as well as for arming the OLT watchdog timer.

REPORT MPCPDUs shall be generated periodically, even when no request for bandwidth is being made. This keeps a watchdog timer in the OLT from expiring and deregistering the ONU. For proper operation of this mechanism the OLT shall grant the ONU periodically.

The Report Processing functional block, and its MPCP protocol elements are designed for use in conjunction with an IEEE 802.1P capable bridge.



**Instances of Service Interface:**  
 MCI = interface to MAC Control multiplexer  
 MCC = interface to MAC Control client

**Figure 144–12—Report Processing service interfaces**

#### 144.3.4.1 Constants

None.

#### 144.3.4.2 Variables

BEGIN

TYPE: Boolean

This variable is used when initiating operation of the functional block state diagram. It is set to true following initialization and every reset.

DataRx

This variable is defined in 144.2.2.3.

DataTx

This variable is defined in 144.2.2.3.

m_sdu_ctl	1
This variable is defined in 144.2.2.3.	2
	3
mpcp_timeout	4
TYPE: 32-bit unsigned integer	5
This variable represents the maximum allowed interval of time between two MPCPDU messages.	6
Failure to receive at least one frame within this interval is considered a fatal fault and leads to	7
deregistration. This variable is expressed in the units of 1 EQ.	8
VALUE: 0x174876E8 (1 s, default value)	9
	10
OpcodeRx	11
This variable is defined in 144.2.2.3.	12
	13
Registered	14
This variable is defined in 144.2.2.3.	15
	16
ReportTimeout	17
TYPE: 32 bit unsigned	18
This variable represents the maximum allowed interval of time between two REPORT messages	19
generated by the ONU, and it is expressed in the units of 1 EQ.	20
VALUE: 0x012A05F2 (50 ms, default value)	21
	22
	23
<b>144.3.4.3 Functions</b>	24
	25
None.	26
	27
<b>144.3.4.4 Timers</b>	28
	29
report_periodic_timer	30
ONUs are required to generate REPORT MPCPDUs with a periodicity of less than ReportTimeout	31
value. This timer counts down time remaining before a forced generation of a REPORT message in	32
an ONU.	33
	34
mpcp_timer	35
This timer is defined in 144.3.3.4.	36
	37
<b>144.3.4.5 Messages</b>	38
	39
MCI:MADR (DA, SA, m_sdu)	40
The service primitive is defined in 2.3.2.	41
	42
MCC:MACR(DA, REPORT, NumNonEmptyQ, ReportTime, LLID[7], QueueLength[7])	43
This service primitive is used by a MAC Control client to request the Report Process at the	44
ONU to transmit a queue status report. This primitive may be called at variable intervals,	45
independently of the granting process, in order to reflect the time varying aspect of the	46
network. This primitive uses the following parameters:	47
DA: Multicast MAC Control address as defined in Annex 31B.	48
REPORT: Opcode for REPORT MPCPDU as defined in Table 31A-1.	49
LLID[7]: Represents the logical link the queue length for which is being	50
reported in the associated <i>QueueLength[i]</i> array.	51
QueueLength[7]: Represents queue length report for each logical link in the	52
associated <i>LLID[i]</i> array.	53
	54

ReportTime: Represents the value carried in the *Report Time* field in the REPORT MPCPDU.  
NumNonEmptyQ: Represents the value carried in the *Number of Non-empty Queues (LLID)* field in the REPORT MPCPDU.

MCC:MACI(REPORT, RTT, NumNonEmptyQ, ReportTime, LLID[7], QueueLength[7])

The service primitive is issued by the Report Process at the OLT to notify the MAC Control client and higher layers the queue status of the MPCP link partner. This primitive may be called multiple times, in order to reflect the time-varying aspect of the network. This primitive uses the following parameters:

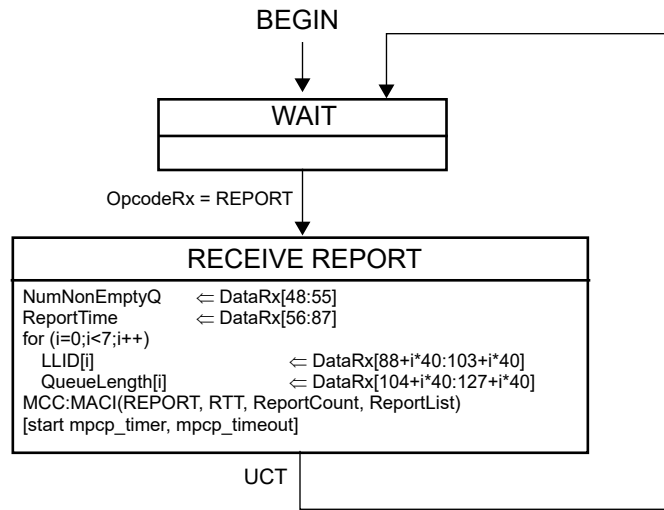
REPORT: Opcode for REPORT MPCPDU as defined in Table 31A-1.  
RTT: This parameter holds an updated round trip time value that is recalculated following each REPORT message reception.  
LLID[7]: Represents the logical link the queue length for which is being reported in the associated *QueueLength[i]* array.  
QueueLength[7]: Represents queue length report for each logical link in the associated *LLID[i]* array.  
ReportTime: Represents the value carried in the *Report Time* field in the REPORT MPCPDU.  
NumNonEmptyQ: Represents the value carried in the *Number of Non-empty Queues (LLID)* field in the REPORT MPCPDU.

OpcodeSpecificFunction(Opcode)

Functions exported from opcode specific blocks that are invoked on the arrival of a MAC Control message of the appropriate opcode.

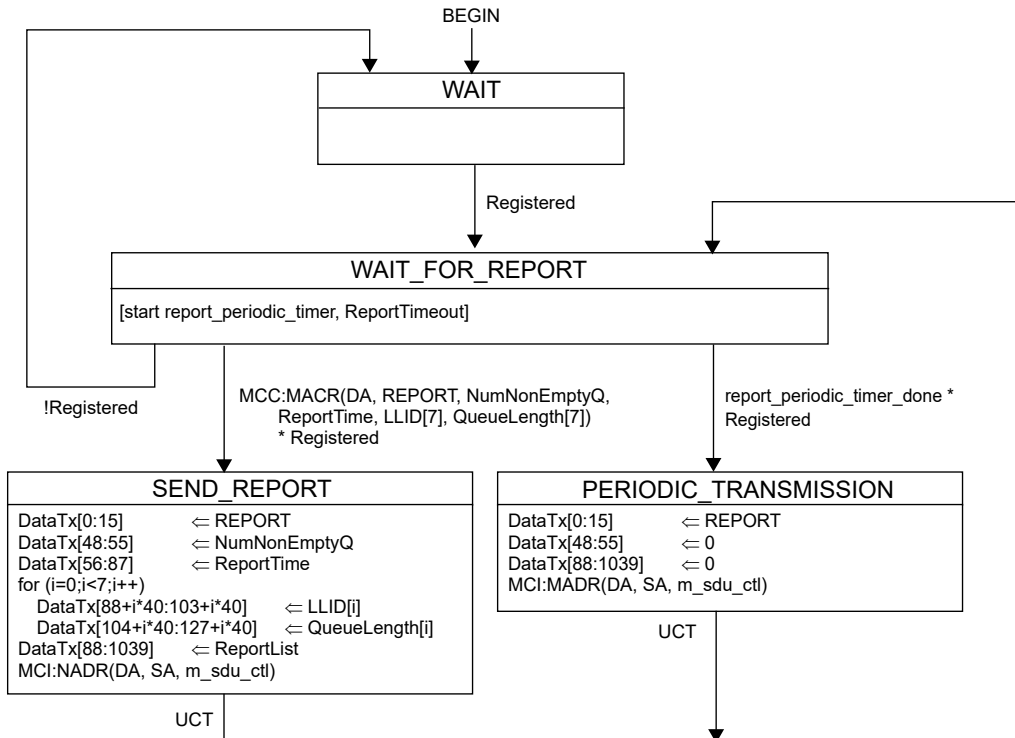
#### 144.3.4.6 State diagrams

The Report Process in the OLT shall implement the Report Processing state diagram as shown in Figure 144-13. The Report Process in the ONU shall implement the Report Processing state diagram as shown in Figure 144-14. Instantiation of state diagrams as described is performed for Multipoint MAC Control instances attached to PLIDs only.



**Instances of Service Interface:**  
 MCI = interface to MAC Control multiplexer  
 MCC = interface to MAC Control client

**Figure 144–13—Report Processing state diagram at OLT**



**Instances of Service Interface:**  
 MCI = interface to MAC Control multiplexer  
 MCC = interface to MAC Control client

**Figure 144–14—Report Processing state diagram at ONU**



### 144.3.5 Gate Processing

A key concept pervasive in Multipoint MAC Control is the ability to arbitrate a single transmitter out of a plurality of ONUs. The OLT controls an ONU's transmission by assigning grants.

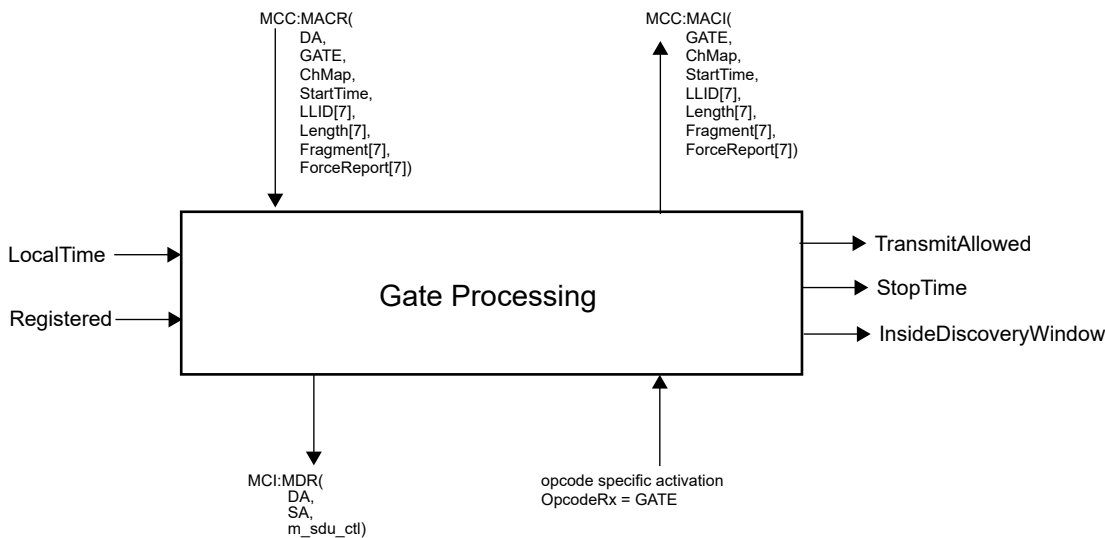
The transmitting window of an ONU is indicated in the GATE message where each granted LLID is explicitly identified (*LLID #n* field, see 144.3.7.1) and granted (*Grant Length #n* field, see 144.3.7.1). All granted LLIDs share the same grant start time (*Grant Start Time* field, see 144.3.7.1). An ONU begins transmission when its *LocalTime* variable matches the value indicated in the *Grant Start Time* field in the GATE message. An ONU concludes its transmission with sufficient margin to ensure that the laser is turned off before the grant length interval has elapsed.

Multiple outstanding grants may be issued to each ONU. The OLT shall not issue more than the maximum supported maximum outstanding grants as advertised by the ONU during registration (see pending grants in 77.3.6.3).

In order to maintain the watchdog timer at the ONU, grants are periodically generated. For this purpose empty GATE messages may be issued periodically.

When registered, the ONU ignores all **DISCOVERY\_GATE** MPCPDUs where the Discovery flag is set.

*Editorial Note (to be removed prior to publication): contributions on what to do in case of granting more than 7 LLID are needed.*



**Instances of Service Interface:**  
 MCI = interface to MAC Control multiplexer  
 MCC = interface to MAC Control client

**Figure 144–15—Gate Processing service interface**

#### 144.3.5.1 Constants

MpcpProcessingDly

TYPE: 32-bit unsigned

This constant represents the minimum time required for the ONU to complete MPCPDU processing, expressed in the units of 1 EQ.

Value: 0x00001900 (16.384  $\mu$ s)

### 144.3.5.2 Variables

#### ChIndex

TYPE: 2-bit unsigned integer

The value of this variable indicates the channel the Envelope Descriptor is intended for, where the value of 0 corresponds to channel 0, value of 1 - channel 1, etc.

#### ChMap[]

TYPE: 4-bit unsigned integer

The value of this variable corresponds the value of bits 0 through 3 of the *Channel Assignment* field in the GATE MPCPDU (see Table 144–1).

#### ChStatus

TYPE: 4-bit unsigned integer

The value of this variable represents a binary-encoded status of individual channels at the ONU. The status of each channel is position encoded, where bit 0 corresponds to channel 0, bit 1 - channel 1, etc. The value of each bit has the following meaning:

1 = channel is enabled

0 = channel is disabled

### 144.3.5.3 Functions

None

### 144.3.5.4 Messages

MA\_DATA.request (DA, SA, m\_sdu)

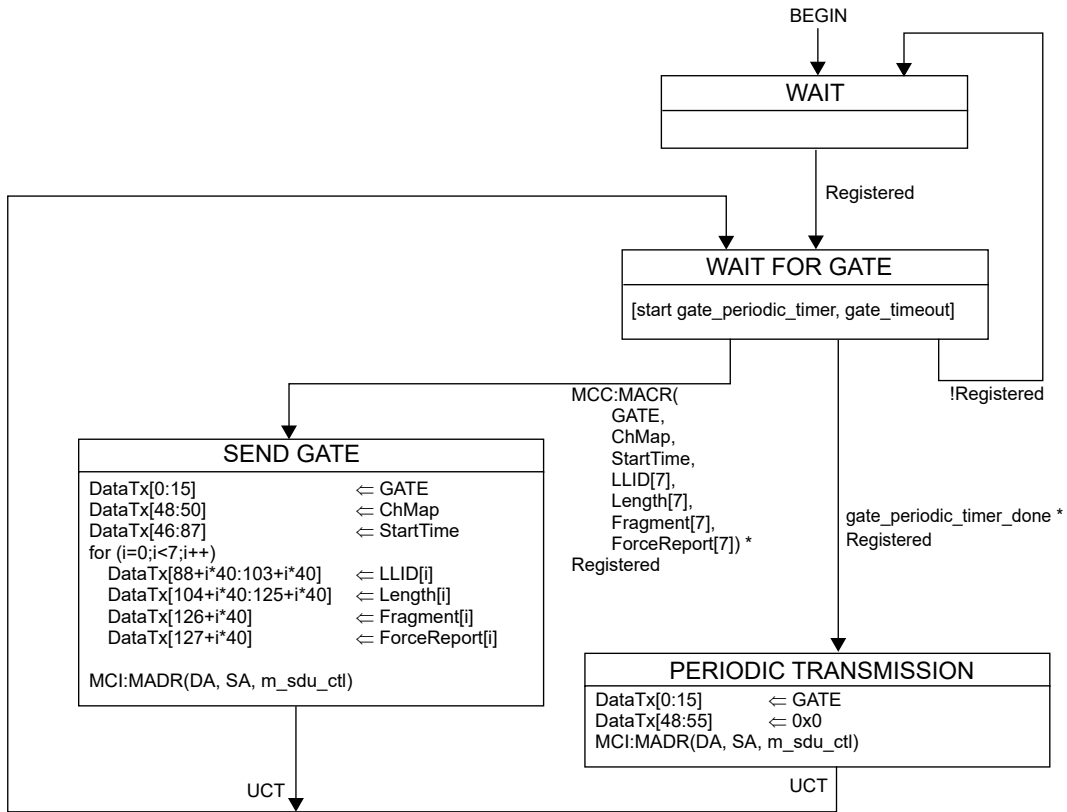
The service primitive is defined in 2.3.2.

MA\_CONTROL.request(DA, GATE, ChMap, StartTime, LLID[7], Length[7], Fragment[7], ForceReport[7])

This service primitive is defined in 144.3.3.5.

### 144.3.5.5 State diagram

The Gate Process in the OLT shall implement the Gate Processing state diagram as shown in Figure 144–16. The Gate Process in the ONU shall implement the Gate Processing state diagram as shown in Figure 144–17. Should there be a discrepancy between a state diagram and descriptive text, the state diagram prevails.



**Instances of Service Interface:**  
 MCI = interface to MAC Control multiplexer  
 MCC = interface to MAC Control client

**Figure 144–16—Gate Processing state diagram at OLT**

1  
2  
3  
4  
5  
6  
7  
8  
9  
10  
11  
12  
13  
14  
15  
16  
17  
18  
19  
20  
21  
22  
23  
24  
25  
26  
27  
28  
29  
30  
31  
32  
33  
34  
35  
36  
37  
38  
39  
40  
41  
42  
43  
44  
45  
46  
47  
48  
49  
50  
51  
52  
53  
54

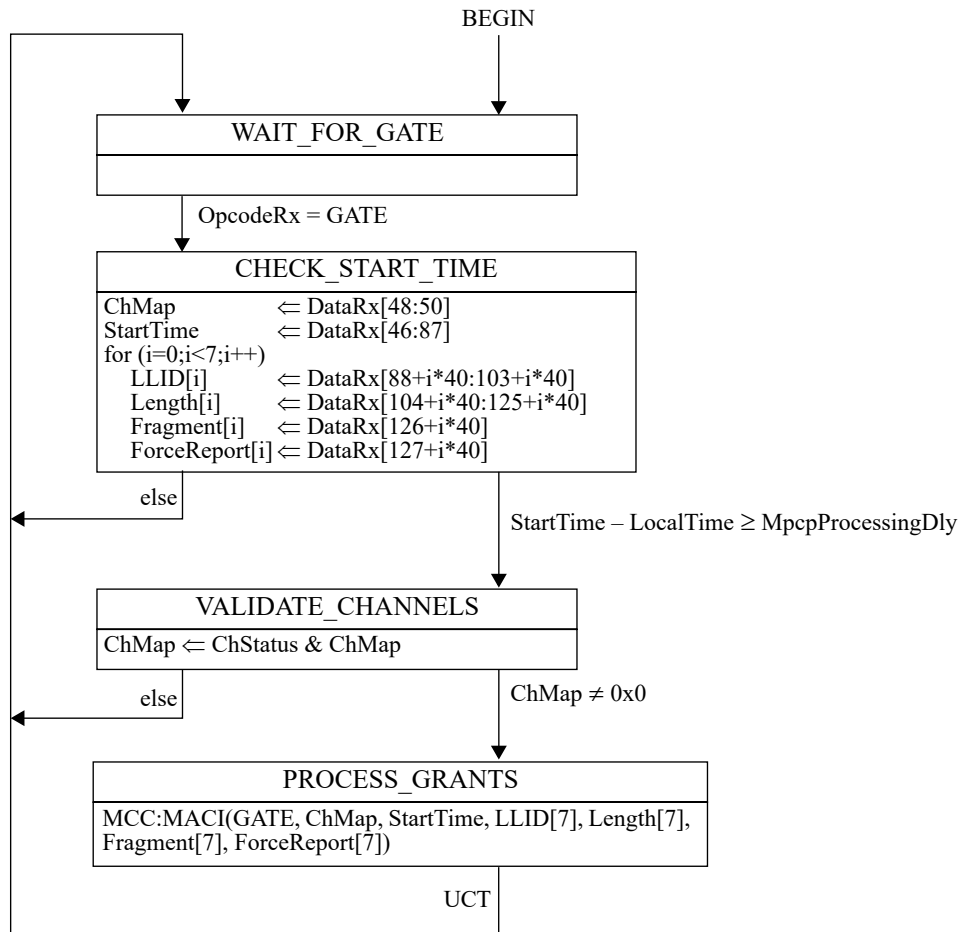


Figure 144–17—ONU GATE Reception Process state diagram

### 144.3.6 MPRS Envelope Activation process

{TBD, introduction text}

**Editorial Note (to be removed prior to publication): individual definitions of variables, constants, and functions will be cross-referenced, rather than repeated.**

#### 144.3.6.1 Constants

FEC\_CODEWORD\_SIZE  
 TYPE: {TBD}  
 {TBD}  
 Value: {TBD}

#### 144.3.6.2 Variables

BurstInProgress[]

TYPE: {TBD}	1
{TBD}	2
ch	3
TYPE: {TBD}	4
{TBD}	5
EnvList[]	6
TYPE: {TBD}	7
{TBD}	8
LocalTime	9
TYPE: {TBD}	10
{TBD}	11
NextEnv	12
TYPE: {TBD}	13
{TBD}	14
PrevStartTime[]	15
TYPE: {TBD}	16
{TBD}	17

### 144.3.6.3 Functions

IsEmpty(EnvList[ch])	25
{TBD}	26
EnvHeader (wCol, epam)	27
{	28
TBD	29
}	30
IsValid(NextEnv.LLID)	31
{TBD}	32
EnvHeader (wCol, epam)	33
{	34
TBD	35
}	36
PeekHead()	37
{TBD}	38
EnvHeader (wCol, epam)	39
{	40
TBD	41
}	42
RemoveHead()	43

### 144.3.6.4 State diagram

The ONU Envelope Activation Process shall implement the state diagram as depicted in Figure 144–18. The OLT Envelope Activation Process shall implement the state diagram as depicted in Figure 144–18. Should there be a discrepancy between a state diagram and descriptive text, the state diagram prevails.

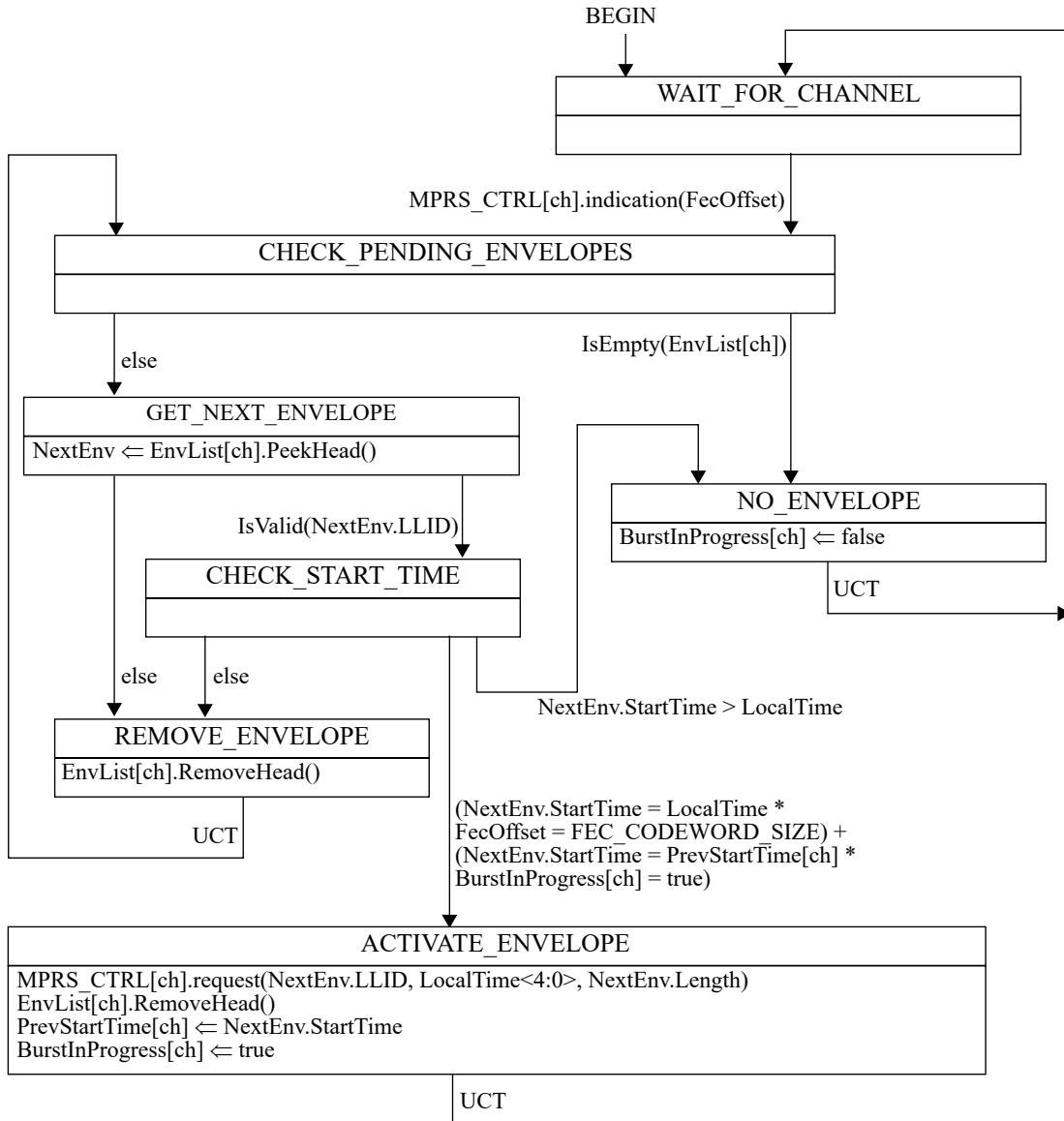


Figure 144-18—Envelope Activation Process state diagram

### 144.3.7 MPCPDU structure and encoding

The MPCPDU structure shall be as shown in Figure 144–19, and is further defined as follows:

- a) Destination Address (DA). The DA in MPCPDU is the MAC Control Multicast address as specified in the annexes to Clause 31, or the individual MAC address associated with the port to which the MPCPDU is destined.
- b) Source Address (SA). The SA in MPCPDU is the individual MAC address associated with the port through which the MPCPDU is transmitted. For MPCPDUs originating at the OLT end, this can be the address any of the individual MACs. These MACs may all share a single unicast address, as explained in 144.1.2.
- c) Length/Type. The Length/Type in MPCPDUs carries the MAC\_Control\_Type field value as specified in 31.4.1.3.
- d) Opcode. The opcode identifies the specific MPCPDU being encapsulated. Values are defined in Table 31A–1.
- e) Timestamp. The timestamp field conveys the content of the *LocalTime* variable (see 144.2.2.2) at the time of transmission of the MPCPDUs. This field is 32 bits long and counts time in the units of 1 EQ.
- f) Data/Reserved/PAD. These 40 octets are used for the payload of the MPCPDUs. When not used they are filled with zeros on transmission, and ignored on reception.
- g) FCS. This field is the Frame Check Sequence, typically generated by the underlying MAC.

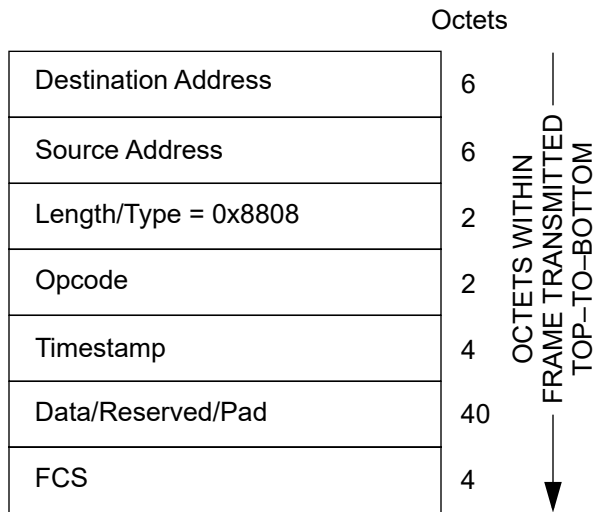
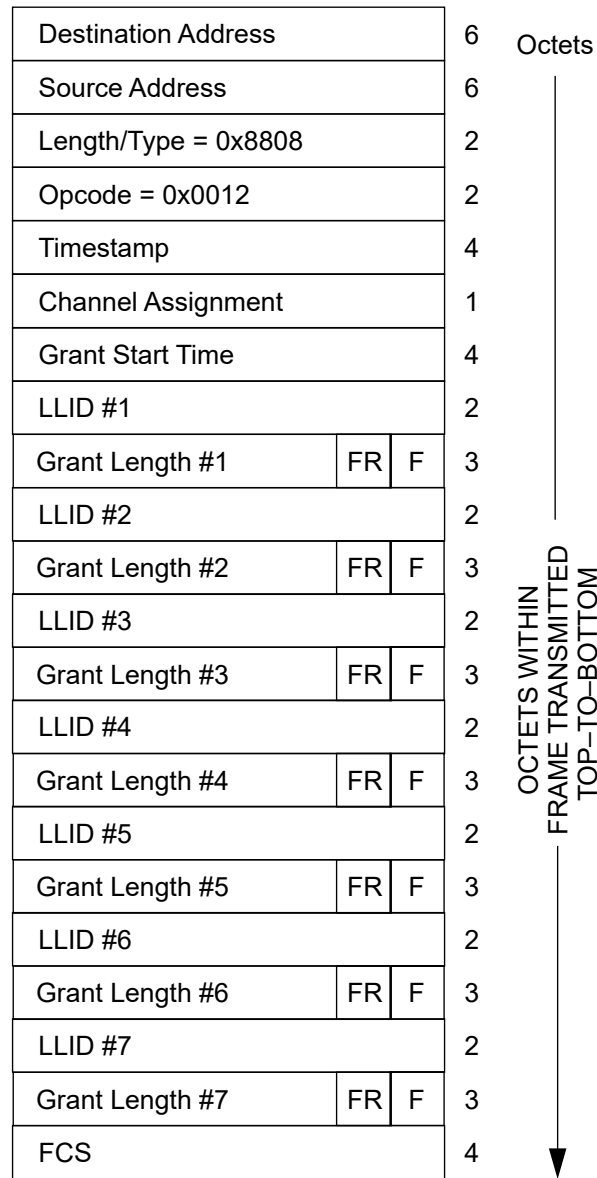


Figure 144–19—Generic MPCPDU

#### 144.3.7.1 GATE description

The purpose of GATE message is to grant transmission windows to ONUs for normal transmission. Up to seven grants can be included in a single GATE MPCPDU. Only grants with non-zero value within the *Grant Length #n* field are processed by the ONU. If the number of grants with non-zero value in the *Grant Length #n* field in the GATE MPCPDU is zero, such a GATE MPCPDU is used as an MPCP keep alive from the OLT to the ONU.



**Figure 144-20—GATE MPCPDU**

The GATE MPCPDU is an instantiation of the Generic MPCPDU, and is further defined as follows:

- a) Opcode. The opcode for the GATE MPCPDU is 0x0012.

1  
2  
3  
4  
5  
6  
7  
8  
9  
10  
11  
12  
13  
14  
15  
16  
17  
18  
19  
20  
21  
22  
23  
24  
25  
26  
27  
28  
29  
30  
31  
32  
33  
34  
35  
36  
37  
38  
39  
40  
41  
42  
43  
44  
45  
46  
47  
48  
49  
50  
51  
52  
53  
54



- b) Channel Assignment: This 8-bit flag register, where bits 0-3 contain a bitmap representing the wave-length channel(s) on which to transmit on during the assigned transmission slot. Bits 4-7 are reserved. Table 144-1 shows the mapping between individual bits and upstream channels.

**Table 144-1—Channel Assignment flags**

Bit	Channel field	Values
0	Upstream channel 0	0 – do not use upstream channel 0 for transmission 1 – use upstream channel 0 for transmission
1	Upstream channel 1	0 – do not use upstream channel 1 for transmission 1 – use upstream channel 1 for transmission
2	Upstream channel 2	0 – do not use upstream channel 2 for transmission 1 – use upstream channel 2 for transmission
3	Upstream channel 3	0 – do not use upstream channel 3 for transmission 1 – use upstream channel 3 for transmission
4-7	Reserved	Reserved

- c) Grant Start Time: This 32-bit unsigned integer value represents the start time of the transmission grant, expressed in the units of 1 EQ. The start time is compared to the local clock, to correlate the start of the grant.
- d) LLID #n: This 16-bit unsigned integer value represents the logical link that is being granted a transmission slot.
- e) Grant Length #n: This 22-bit unsigned value represents the length of the grant assigned to LLID #n. The length of the granted transmission slot is expressed in the units of 1 EQ. Up to 7 grants may be packed into a single GATE MPCPDU. All transmission overhead components (see TBD) are included in and thus consume part of the granted transmission slot.
- f) Fragmentation (F): (TBD)
- g) Forced Report (FR): When the respective bit is set to 0, no action is required from the ONU. When the respective bit is set to 1, the ONU should issue a REPORT MPCPDU during the transmission grant indicated by the *Grant Length #n* field associated with this *Forced Report* flag.
- h) Pad/Reserved. This is an empty field that is transmitted as zeros, and ignored on reception. The size of this field depends on the used *Grant Length #n / LLID #n* entry-pairs as well as the presence of any optional fields, and varies in length from 0-30 accordingly.

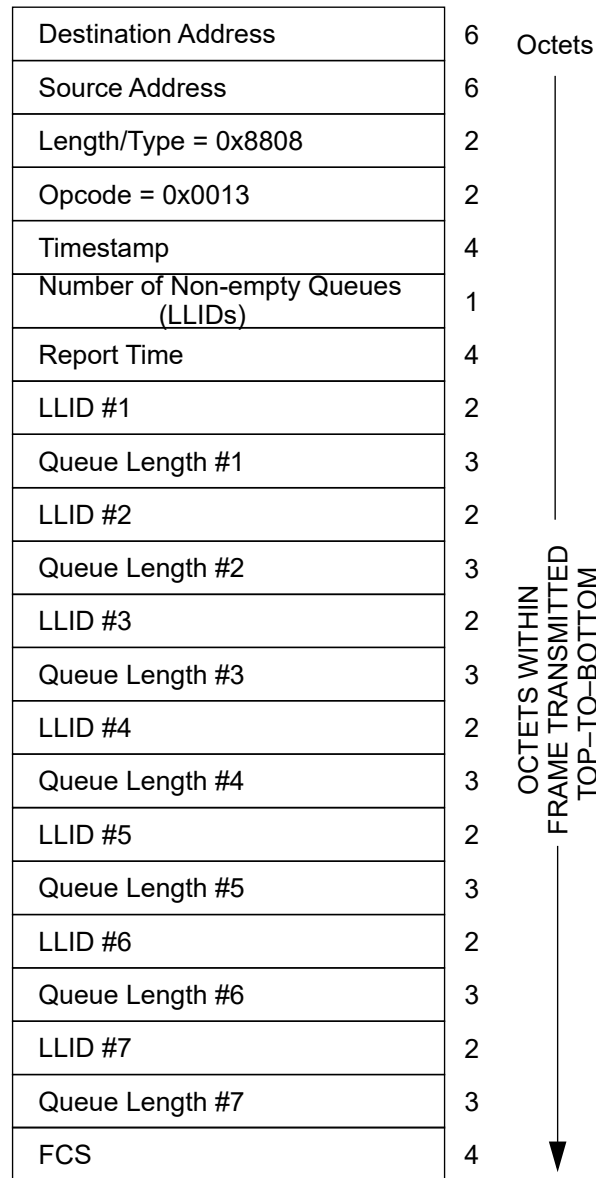
### 144.3.7.2 REPORT description

REPORT MPCPDU has several functionalities, i.e.:

- Time stamp carried in the *Timestamp* field in each REPORT MPCPDU is used for round trip time (RTT) calculation,
- ONUs use the REPORT MPCPDUs to indicate the amount of data queued in individual LLIDs, and
- REPORT MPCPDUs are also used as keep-alives from ONU to the OLT.

The REPORT MPCPDU is an instantiation of the Generic MPCPDU, and is further defined as follows:

- a) Opcode. The opcode for the REPORT MPCPDU is 0x0013.
- b) Number of Non-empty Queues (LLIDs): (TBD)
- c) Report Time: (TBD)



**Figure 144-21—REPORT MPCPDU**

- d) LLID #n: This 16-bit unsigned integer value represents the logical link that is reporting the queue occupancy.
- e) Queue Length #n: This 24-bit unsigned value represents the occupancy of the queue assigned to LLID #n, at time *Report Time*. The value of the queue occupancy is expressed in the units of 1 EQ. Up to 7 queues may be packed into a single REPORT MPCPDU.
- f) Pad/Reserved. This is an empty field that is transmitted as zeros, and ignored on reception. The size of this field depends on the used *Queue Length #n / LLID #n* entry-pairs as well as the presence of any optional fields, and varies in length from 0-35 accordingly.

The REPORT MPCPDU shall be generated by a MAC Control instance mapped to an active ONU, and as such shall be marked with a unicast type of LLID (see TBD).

1  
2  
3  
4  
5  
6  
7  
8  
9  
10  
11  
12  
13  
14  
15  
16  
17  
18  
19  
20  
21  
22  
23  
24  
25  
26  
27  
28  
29  
30  
31  
32  
33  
34  
35  
36  
37  
38  
39  
40  
41  
42  
43  
44  
45  
46  
47  
48  
49  
50  
51  
52  
53  
54

### 144.3.7.3 REGISTER\_REQ description

The REGISTER\_REQ MPCPDU is an instantiation of the Generic MPCPDU, and is further defined as follows:

- a) Opcode. The opcode for the REGISTER\_REQ MPCPDU is 0x0014.
- b) Flags. This is an 8 bit flag register that indicates special requirements for the registration, as presented in Table 144–2.

**Table 144–2—REGISTER\_REQ MPCPDU Flags fields**

Value	Indication	Comment
0	Reserved	Ignored on reception.
1	Register	Registration attempt for ONU.
2	Reserved	Ignored on reception.
3	Deregister	This is a request to deregister the ONU. Subsequently, the MAC is deallocated and the LLID may be reused.
4–255	Reserved	Ignored on reception.

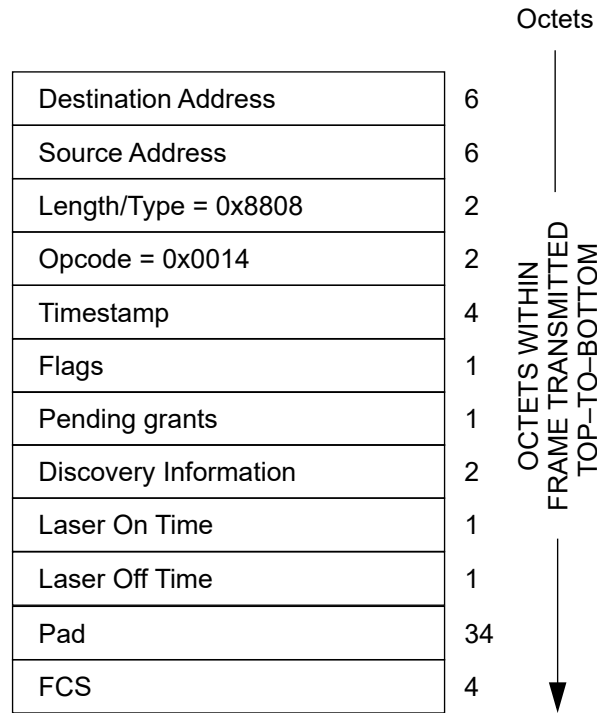
- c) Pending Grants. This is an unsigned 8 bit value signifying the maximum number of future grants the ONU is configured to buffer. The OLT should not grant the ONU more than this maximum number of *Pending grants* vectors comprised of {llid, grant length, force\_report, fragmentation} into the future.
- d) Discovery Information. This is a 16 bit flag register. Table 144–3 presents the structure of the Discovery Information flag.

**Table 144–3—Discovery Information Fields**

Bit	Flag field	Values
0	Reserved	Ignored on Reception
1	ONU is 10G upstream capable	0 – ONU transmitter is not capable of 10 Gb/s 1 – ONU transmitter is capable of 10 Gb/s
2	ONU is 25G upstream capable	0 – ONU transmitter is not capable of 25 Gb/s 1 – ONU transmitter is capable of 25 Gb/s
3-4	Reserved	Ignored on Reception
5	10G registration attempt	0 - 10 Gb/s registration is not attempted 1 - 10 Gb/s registration is attempted
6	25G registration attempt	0 - 25 Gb/s registration is not attempted 1 - 25 Gb/s registration is attempted
7-15	Reserved	Ignored on Reception

- e) Laser On Time. This field is 1 octet long and carries the Laser On Time characteristic for the given ONU transmitter. The value is expressed in the units of 1 EQ.
- f) Laser Off Time. This field is 1 octet long and carries the Laser Off Time characteristic for the given ONU transmitter. The value is expressed in the units of 1 EQ.
- g) Pad/Reserved. This is an empty field that is transmitted as zeros, and ignored on reception. The size of this field is fixed and equal to 34.

The REGISTER\_REQ MPCPDU shall be generated by a MAC Control instance mapped to an undiscovered ONU, and as such shall be marked with a broadcast type of LLID (see **TBD**).



**Figure 144-22—REGISTER\_REQ MPCPDU**

**144.3.7.4 REGISTER description**

The REGISTER MPCPDU is an instantiation of the Generic MPCPDU, and is further defined as follows:

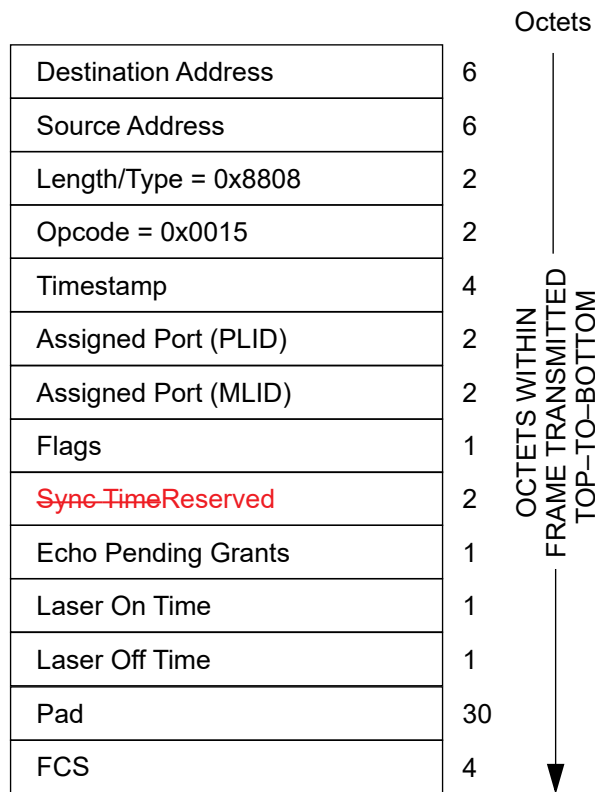
- a) DA. The destination address used shall be an individual MAC address.
- b) Opcode. The opcode for the REGISTER MPCPDU is 0x0015.
- c) Assigned Port (PLID). This field holds a 16 bit unsigned value reflecting the Physical LLID (see 143.2.1.1) of the port assigned following registration.
- d) Assigned Port (MLID). This field holds a 16 bit unsigned value reflecting the Management LLID (see 143.2.1.2) of the port assigned following registration.
- e) Flags. this is an 8 bit flag register that indicates special requirements for the registration, as presented in Table 144-4.

**Table 144-4—REGISTER MPCPDU Flags field**

Value	Indication	Comment
0	Reserved	Ignored on reception.
1	Reregister	The ONU is explicitly asked to re-register.
2	Deregister	This is a request to deallocate the port and free the LLID. Subsequently, the MAC is deallocated.
3	Ack	The requested registration is successful.
4	Nack	The requested registration attempt is denied by the MAC Control Client.
5-255	Reserved	Ignored on reception.

- f) ~~Sync Time. This is an unsigned 16-bit value signifying the required synchronization time of the OLT receiver. The value is counted in 1 EQ increments. The advertised value includes synchronization requirement on all receiver elements including PMD, PMA, and PCS.~~
- g) Echoed Pending Grants. This is an unsigned 8-bit value signifying the number of future grants the ONU may buffer before activating. The OLT should not grant the ONU more than this number of grants into the future.
- h) Laser On Time. This is an unsigned 8-bit value, expressed in the units of 1 EQ, signifying the Laser On Time for the given ONU transmitter. This value may be different from Laser On Time delivered by the ONU in the REGISTER\_REQ MPCPDU during the Discovery process. The ONU updates the local *LaserOnTime* variable per state diagram in Figure 144–11.
- i) Laser Off Time. This is an unsigned 8-bit value, expressed in the units of 1 EQ, signifying the Laser Off Time for the given ONU transmitter. This value may be different from Laser Off Time delivered by the ONU in the REGISTER\_REQ MPCPDU during the Discovery process. The ONU updates the local *LaserOffTime* variable per state diagram in Figure 144–11.
- j) Pad/Reserved. This is an empty field that is transmitted as zeros, and ignored on reception. The size of this field is fixed and equal to 30.

The REGISTER MPCPDU shall be generated by a MAC Control instance mapped to all ONUs and such frame is marked by the broadcast LLID (see **TBD**).



**Figure 144–23—REGISTER MPCPDU**

#### 144.3.7.5 REGISTER\_ACK description

The REGISTER\_ACK MPCPDU is an instantiation of the Generic MPCPDU, and is further defined as follows:

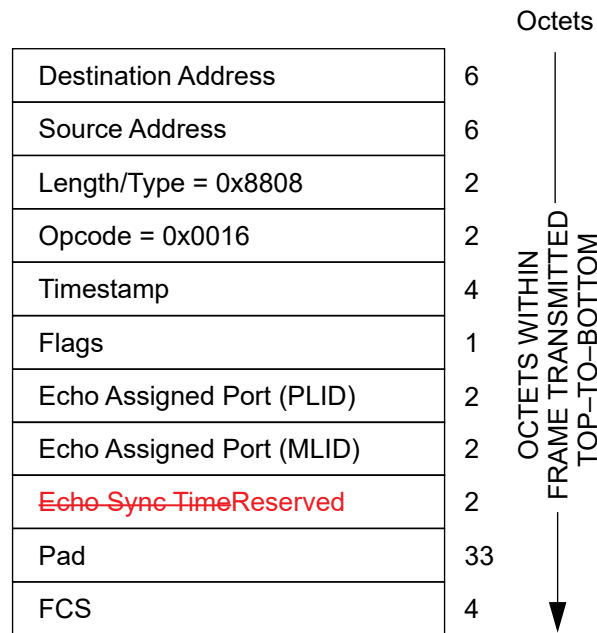
- a) Opcode. The opcode for the REGISTER\_ACK MPCPDU is 0x0016.
- b) Flags. This is an 8-bit flag register that indicates special requirements for the registration, as presented in Table 144-5.

**Table 144-5—REGISTER\_ACK MPCPDU Flags fields**

Value	Indication	Comment
0	Nack	The requested registration attempt is denied by the MAC Control Client.
1	Ack	The registration process is successfully acknowledged.
2-255	Reserved	Ignored on reception.

- c) Echoed Assigned Port (PLID). This field holds a 16-bit unsigned value reflecting the Physical LLID (see 143.2.1.1) for the port assigned following registration.
- d) Echoed Assigned Port (MLID). This field holds a 16-bit unsigned value reflecting the Management LLID (see 143.2.1.2) for the port assigned following registration.
- e) ~~Echoed Sync Time. This is an unsigned 16-bit value echoing the required synchronization time of the OLT receiver as previously advertised (144.3.7.4).~~
- f) Pad/Reserved. This is an empty field that is transmitted as zeros, and ignored at reception. The size of this field is fixed and equal to 33.

The REGISTER\_ACK MPCPDU shall be generated by a MAC Control instance mapped to an active ONU, and as such shall be marked with a unicast type of LLID (see **TBD**).



**Figure 144-24—REGISTER\_ACK MPCPDU**

**144.3.7.6 DISCOVERY\_GATE description**

The **DISCOVERY\_GATE** MPCPDU is an instantiation of the Generic MPCPDU, and is further defined as follows:

- a) Opcode. The opcode for the **DISCOVERY\_GATE** MPCPDU is 0x0017.
- b) Channel Assignment: This 8-bit flag register, where bits 0-3 contain a bitmap representing the wavelength channel(s) on which to transmit on during the assigned transmission slot. Bits 4-7 are reserved. Table 144–1 shows the mapping between individual bits and upstream channels.
- c) Start Time: This 32-bit unsigned integer value represents the start time of the transmission grant, expressed in the units of 1 EQ. The start time is compared to the local clock, to correlate the start of the grant.
- d) Discovery Grant Length: This 24-bit unsigned field represents the length of the discovery grant, expressed in the units of 1 EQ.
- e) ~~Sync Time. This is an unsigned 16-bit value signifying the required synchronization time of the OLT receiver. The value is counted in 1 EQ increments. The advertised value includes synchronization requirement on all receiver elements including PMD, PMA, and PCS.~~
- f) Discovery Information. This is a 16-bit flag register. Table 144–6 presents the internal structure of the Discovery Information flag field.

**Table 144–6—Discovery Information Fields**

Bit	Flag field	Values
0	Reserved	Ignored on Reception
1	OLT is 10G upstream capable	0 – OLT does not support 10 Gb/s reception 1 – OLT supports 10 Gb/s reception
2	OLT is 25G upstream capable	0 – OLT does not support 25 Gb/s reception 1 – OLT supports 25 Gb/s reception
3-4	Reserved	Ignored on Reception
5	OLT is opening 10G discovery window	0 – OLT cannot receive 10 Gb/s data in this window 1 – OLT can receive 10 Gb/s data in this window
6	OLT is opening 25G discovery window	0 – OLT cannot receive 25 Gb/s data in this window 1 – OLT can receive 25 Gb/s data in this window
7-9	ONU Rx_RSSI indication	000 – registration for all ONUs 001 – registration for ONUs Rx_RSSI<th1 010 – registration for ONUs Rx_RSSI≥th1 100 – registration for ONUs Rx_RSSI<th0 101 – registration for ONUs Rx_RSSI≥th0 & Rx_RSSI<th1 110 – registration for Rx_RSSI≥th1 & Rx_RSSI<th2 111 – registration for ONUs Rx_RSSI≥th2
10-15	Reserved	Ignored on Reception

*Editorial Note (to be removed prior to publication): Motion #9 from 2019/03 meeting states: “In order to extend OLT burst receiver dynamic range, move to extend the discovery message shown in umeda\_3-ca\_1b\_0318.pdf pages 7 and 8 to support ONUs with different RX\_RSSI to be registered in different time slots. Align the table with new bit positions in draft as amended in this meeting”. However, both slides 7 and 8 from the referenced deck show different changes to Discovery Information field with no way to reconcile both changes in a single message format. Clarification via comment is needed.*

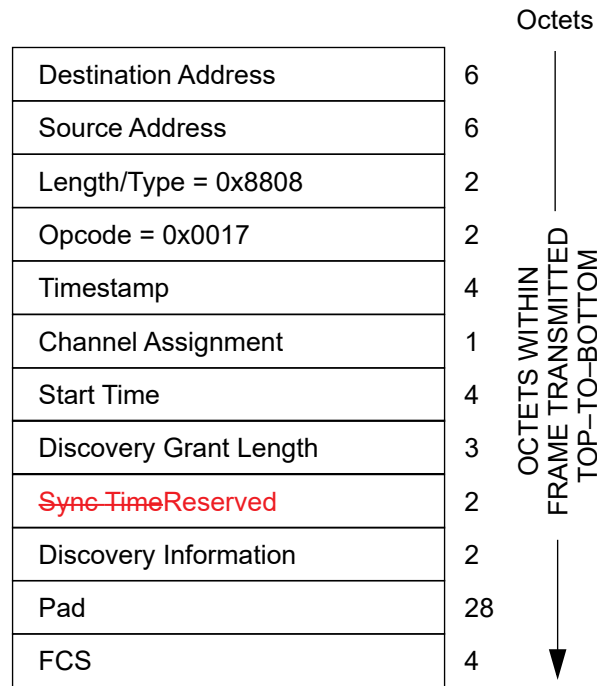


Figure 144-25—DISCOVERY\_GATE MPCPDU

144.3.7.7 SYNC\_PATTERN description

The SYNC\_PATTERN MPCPDU is an instantiation of the Generic MPCPDU, and is further defined as follows:

- a) Opcode. The opcode for the SYNC\_PATTERN MPCPDU is 0x0018.
- b) SpInfo: This is an 16-bit field, with individual bits defined per Table 144-7.

Table 144-7—SpInfo field value

Bit(s)	Field Name	Meaning
0-1	SpIndex	Indicates the index of the Sync Pattern element being configured by the OLT. Valid values for the SP Index field include 0, ... , SpCount-1. Other values are reserved and ignored on reception.
2	Reserved	Ignored on reception
3-4	SpCount	Indicates the number of Sync Pattern elements expected to be configured by the OLT. Two values are expected, i.e., 2 or 3. Other values are reserved and ignored on reception.
5-6	Reserved	Ignored on reception
7	SpBalanced	Indicates whether the given Sync Pattern element is to be transmitted as balanced (when set to 1) or not (when set to 0)
8-14	Reserved	Ignored on reception
15	SpValue, bit 0	Carries the 1 <sup>st</sup> (index 0) bit of the Sync Pattern value carried in the SpValue field

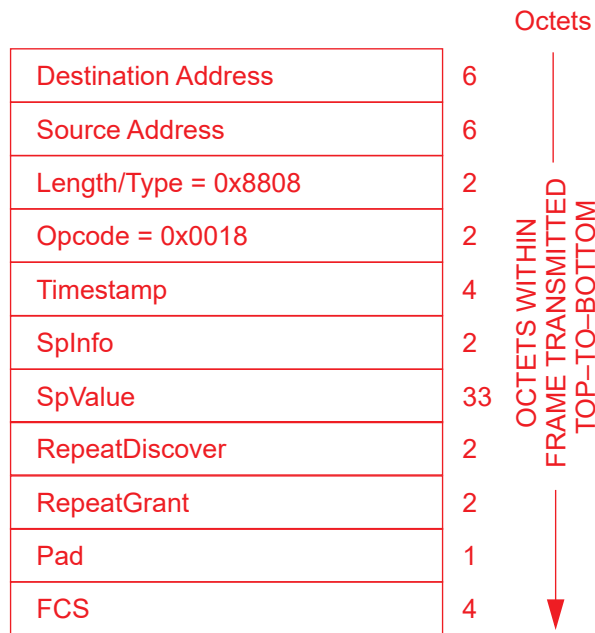


- c) SpValue: This is a 32-octet field, containing right-justified bits 1 through 256 of the Sync Pattern element (SP<sub>1</sub>, SP<sub>2</sub>, or (if present) SP<sub>3</sub>), where bit 0 of the Sync Pattern is carried in the SpInfo field. The allocation of remaining 256 bits in the SpValue field is shown in Table 144–8.

**Table 144–8—Sync Pattern placement in SpValue field**

Octet	Value (binary)
0	SP<8:1>
...	...
30	SP<248:241>
31	SP<256:249>

- d) RepeatDiscover: This is an 16-bit field, value-encoded to indicate the number of times the given portion of the Sync Pattern is repeated when used during the Discovery Window only. Valid values for this field range from 0 to 2<sup>16</sup>-1.
- e) RepeatGrant: This is an 16-bit field, value-encoded to indicate the number of times the given portion of the Sync Pattern is repeated when used outside the Discovery Window, i.e., during the normal granting operation. Valid values for this field range from 0 to 2<sup>16</sup>-1.
- f) Pad/Reserved. This is an empty field that is transmitted as zeros, and ignored at reception. The size of this field is fixed and equal to 1.



**Figure 144–26—SYNC\_PATTERN MPCPDU**

## 144.4 Discovery Process in dual-rate systems

### 144.4.1 OLT speed-specific discovery

### 144.4.2 ONU speed-specific registration

## 144.5 Protocol implementation conformance statement (PICS) proforma for Clause 144, Multipoint MAC Control<sup>4</sup>

### 144.5.1 Introduction

The supplier of a protocol implementation that is claimed to conform to Clause 144 Multipoint MAC Control, shall complete the following protocol implementation conformance statement (PICS) proforma.

A detailed description of the symbols used in the PICS proforma, along with instructions for completing the PICS proforma, can be found in Clause 21.

### 144.5.2 Identification

#### 144.5.2.1 Implementation identification

Supplier	
Contact point for inquiries about the PICS	
Implementation Name(s) and Version(s)	
Other information necessary for full identification—e.g., name(s) and version(s) for machines and/or operating systems; System Name(s)	
NOTE 1—Only the first three items are required for all implementations; other information may be completed as appropriate in meeting the requirements for the identification.	
NOTE 2—The terms Name and Version should be interpreted appropriately to correspond with a supplier’s terminology (e.g., Type, Series, Model).	

#### 144.5.2.2 Protocol summary

Identification of protocol standard	IEEE Std 802.3-201x, Clause 144, Multipoint MAC Control
Identification of amendments and corrigenda to this PICS proforma that have been completed as part of this PICS	
Have any Exception items been required? No [ ] Yes [ ] (See Clause 21; the answer Yes means that the implementation does not conform to IEEE Std 802.3-201x.)	
Date of Statement	

#### 144.5.3 Major capabilities/options

<sup>4</sup>Copyright release for PICS proformas: Users of this standard may freely reproduce the PICS proforma in this subclause so that it can be used for its intended purpose and may further publish the completed PICS.

Item	Feature	Subclause	Value/Comment	Status	Support

1  
2  
3  
4  
5  
6  
7  
8  
9  
10  
11  
12  
13  
14  
15  
16  
17  
18  
19  
20  
21  
22  
23  
24  
25  
26  
27  
28  
29  
30  
31  
32  
33  
34  
35  
36  
37  
38  
39  
40  
41  
42  
43  
44  
45  
46  
47  
48  
49  
50  
51  
52  
53  
54