

Interaction of Package Parameters – Comment #145

Yasuo Hidaka
Fujitsu Laboratories of America, Inc.

IEEE P802.3cd Task Force,
Vancouver, BC, March 13-14, 2017

Supporters

- Toshiaki Sakai (Socionext)
- Mike Dudek (Cavium)

Basic Problem: Interaction of Impedance

- The basic problem is called an *interaction* between channel impedance and device impedance (i.e. Z_c and R_d in COM parameters).
 - Hence, impedance matching depends on impedance *of each other*

■ Example

- Device X is good with Channel A, but not good with Channel B, whereas
- Device Y is good with Channel B, but not good with Channel A

	Device X (90Ω)	Device Y (110Ω)
Channel A (90Ω)	Good	Not Good
Channel B (110Ω)	Not Good	Good

- The problem is simple, but this is the source of complication, because DUT and test environment interact with each other

- Each component is usually tested in the worst condition
 - This is the traditional and safe way to define a standard
 - It guarantees plug and play of multiple components

- Because of the interaction between channel and device, there is no single value of impedance which is the worst for any channel or device

- Ideally, we should test each component with all possible values of impedance which may be the worst condition
 - First, I will discuss this ideal worst-condition test
 - However, this is not practical, because the test time becomes too long
 - I will discuss work arounds later
 - I will also discuss the pessimism of multiple worst conditions later

- Calculate COM for all combinations of R_d and Z_c in Tx and Rx
- Channel Test
 - Test the *min* COM value with the spec value
- Rx Interference Tolerance Test
 - Calibrate test channel to align its *max* COM value to the spec value
 - Note that aligning its *min* COM value (D1.2) is not necessarily stressful for Rx
 - Also note that we are already specifying the max value of COM for Rx ITT
 - Use the same spec value as the channel test

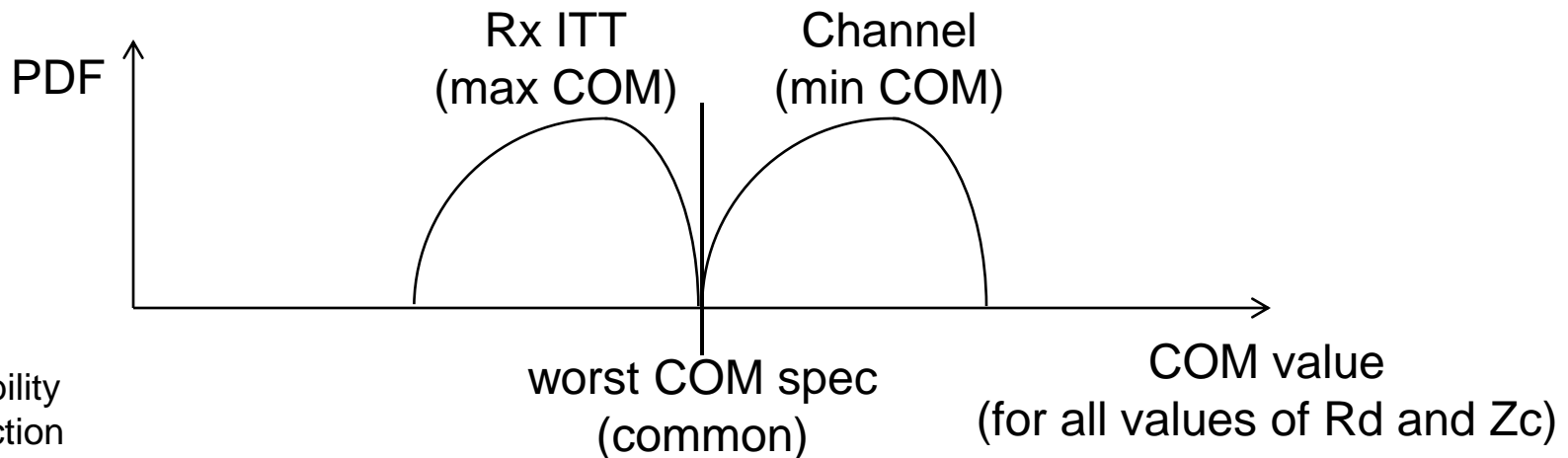

Work Around Option 1

■ Estimate the worst COM value in an efficient way

■ Already reported in mellitz_020117_3cd_adhoc

1. Optimize the LE (FFE/CTLE/LFE) parameters for typical R_d and Z_c
2. Calculate COM for all max/min combinations of R_d and Z_c using the LE parameters obtained in step 1
3. Choose the R_d and Z_c values which resulted the worst COM in step 2 (worst means min for channel test, and max for Rx ITT)
4. Re-calculate COM for the R_d and Z_c values chosen in step 3 after re-optimizing LE parameters as the final worst COM value

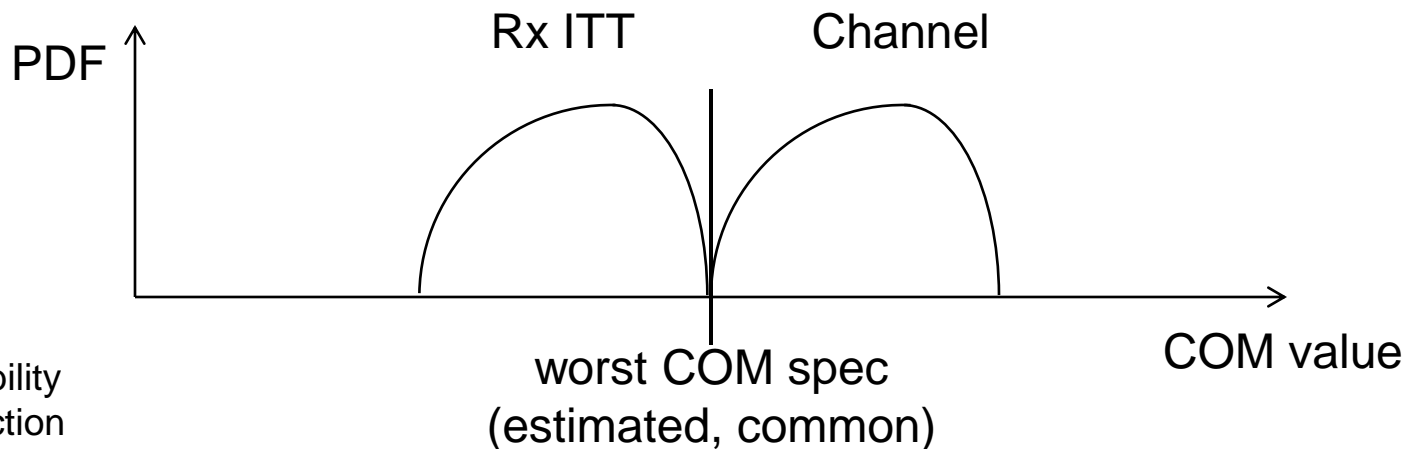

Work Around Option 2

- Test in the typical condition and offset the COM spec value
 - Calculate COM just once using typical R_d and Z_c
 - Shift the COM spec value for an expected amount of offset
 - Channel Test: Increase the COM spec by X dB
 - Rx ITT: Decrease the COM spec by Y dB

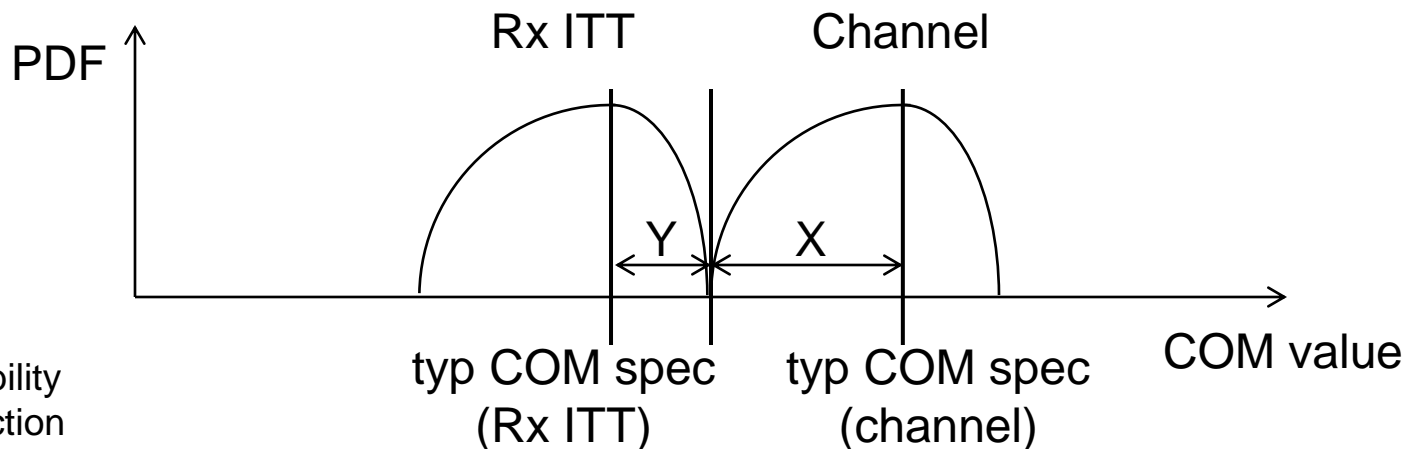

Overview of Simulation Study

- Conducted a large number of COM simulations
 - 28 channels (10/20/30dB loss, Cisco/TE/Intel 100Ω/Intel 85Ω/Cavium)
 - 34 COM parameters (min/max or typ Rd/Zc in Tx/Rx, zp=12mm/30mm)
 - 2 nominal Zc values (nominal 93Ω or 100Ω)

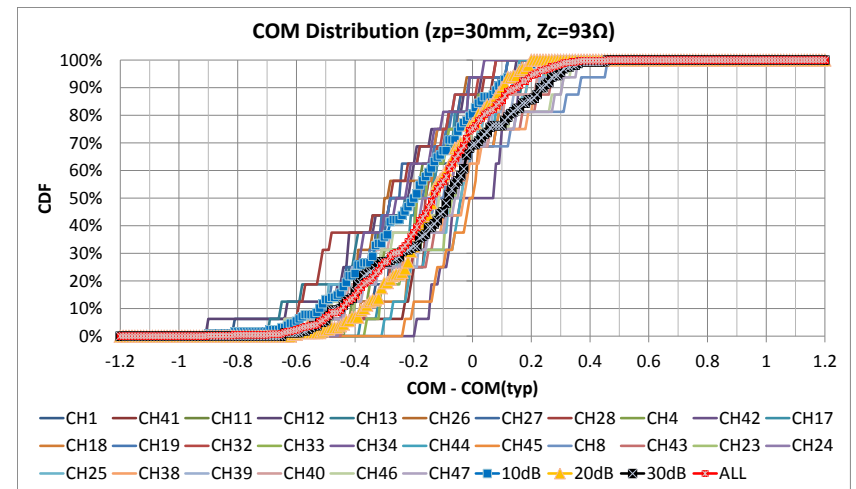
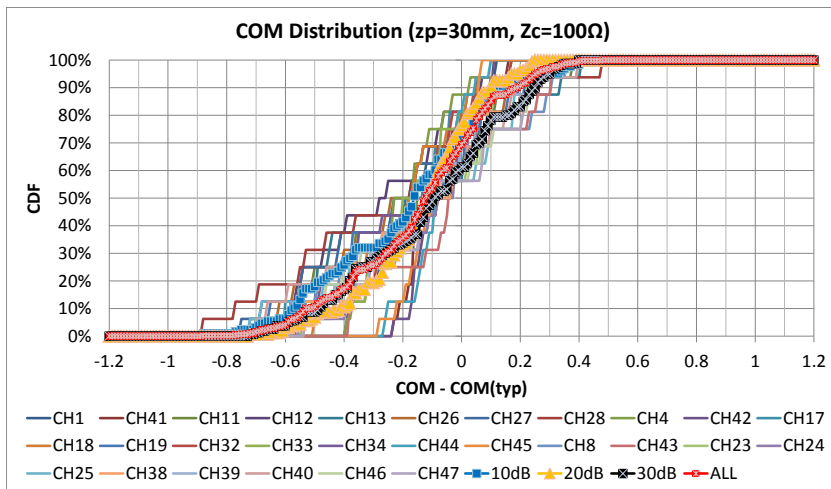
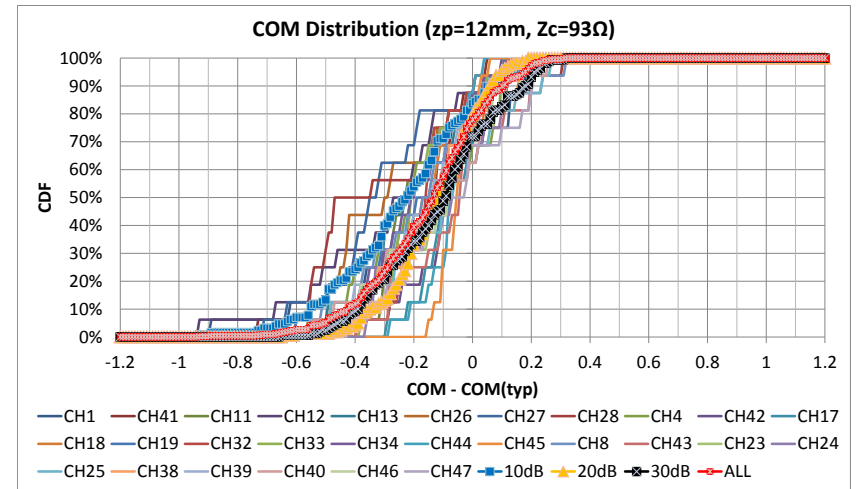
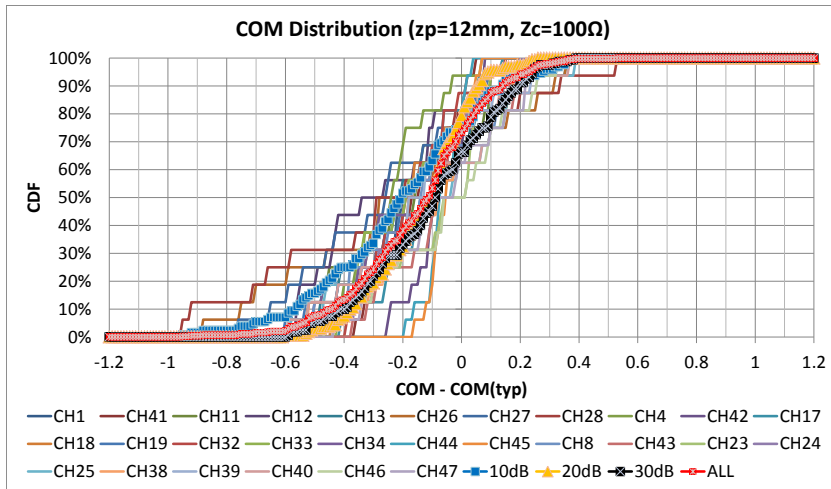

Accuracy of Estimated Worst COM in Option 1

■ Min COM (estimated) – Min COM (actual)

Zc (nominal)	100Ω				93Ω			
zp	12mm		30mm		12mm		30mm	
channel loss	avg	min ~ max	avg	min ~ max	avg	min ~ max	avg	min ~ max
10dB (8 samples)	0.01	0.00(6)~0.07	0.01	0.00(6)~0.10	0.00	0.00(7)~0.02	0.01	0.00(6)~0.05
20dB (10 samples)	0.05	0.00(5)~0.28	0.01	0.00(9)~0.06	0.03	0.00(7)~0.14	0.01	0.00(9)~0.07
30dB (10 samples)	0.00	0.00(10)	0.00	0.00(10)	0.03	0.00(6)~0.18	0.00	0.00(9)~0.01

■ Max COM (estimated) – Max COM (actual)

Zc (nominal)	100Ω				93Ω			
zp	12mm		30mm		12mm		30mm	
channel loss	avg	min ~ max	avg	min ~ max	avg	min ~ max	avg	min ~ max
10dB (8 samples)	-0.01	-0.03~0.00(6)	-0.01	-0.11~0.00(7)	-0.01	-0.06~0.00(7)	0.00	0.00(8)
20dB (10 samples)	-0.02	-0.13~0.00(8)	-0.01	-0.06~0.00(6)	-0.02	-0.08~0.00(7)	-0.02	-0.13~0.00(6)
30dB (10 samples)	-0.01	-0.07~0.00(8)	-0.04	-0.23~0.00(5)	-0.02	-0.14~0.00(6)	-0.01	-0.06~0.00(8)

The number of exactly matched samples is shown in parenthesis

■ Estimated Worst COM is quite accurate

Offset (X and Y) Values for Option 2

■ Typ COM – Min COM (actual)

Zc (nominal)	100Ω				93Ω			
zp	12mm		30mm		12mm		30mm	
channel loss	avg	min ~ max	avg	min ~ max	avg	min ~ max	avg	min ~ max
10dB (8 samples)	0.64	0.36 ~ 0.95	0.60	0.23 ~ 0.89	0.70	0.49 ~ 0.94	0.64	0.44 ~ 0.91
20dB (10 samples)	0.39	0.16 ~ 0.60	0.47	0.24 ~ 0.73	0.41	0.16 ~ 0.65	0.41	0.19 ~ 0.61
30dB (10 samples)	0.51	0.37 ~ 0.59	0.59	0.39 ~ 0.73	0.48	0.36 ~ 0.65	0.54	0.45 ~ 0.65

■ Max COM (actual) – Typ COM

Zc (nominal)	100Ω				93Ω			
zp	12mm		30mm		12mm		30mm	
channel loss	avg	min ~ max	avg	min ~ max	avg	min ~ max	avg	min ~ max
10dB (8 samples)	0.27	0.05 ~ 0.52	0.31	0.11 ~ 0.47	0.17	0.05 ~ 0.31	0.17	0.07 ~ 0.29
20dB (10 samples)	0.15	0.03 ~ 0.26	0.18	0.07 ~ 0.24	0.12	0.03 ~ 0.19	0.14	0.04 ~ 0.20
30dB (10 samples)	0.28	0.19 ~ 0.38	0.32	0.27 ~ 0.40	0.23	0.17 ~ 0.32	0.30	0.23 ~ 0.45

■ Recommended Offset

- 0.6dB offset for channel test (X), 0.3dB offset for Rx ITT (Y)

■ Offset cannot be accurate

Pros and Cons of Option 1 and 2

	Option 1	Option 2
Pros	<ul style="list-style-type: none">• Always tested in the worst case• Accurate• No need to revise the amount of offset for some future spec	<ul style="list-style-type: none">• Simple procedure• No update of COM tool• No major update of spec text
Cons	<ul style="list-style-type: none">• Complicated procedure• Need major update of COM tool• Need major update of spec text• About double CPU time	<ul style="list-style-type: none">• Higher risk than option 1 due to variation of distribution, as we skip the worst-condition test• May not guarantee plug & play• May need to revise the amount of offset for some future spec

Difference from Baseline COM (D1.2)

■ Baseline COM – Min COM (actual)

Zc (nominal)	100Ω				93Ω			
zp	12mm		30mm		12mm		30mm	
channel loss	avg	min ~ max	avg	min ~ max	avg	min ~ max	avg	min ~ max
10dB (8 samples)	0.42	0.00 ~ 1.04	0.39	0.01 ~ 0.71	0.06	0.00 ~ 0.29	0.02	0.00 ~ 0.13
20dB (10 samples)	0.28	0.00 ~ 0.59	0.38	0.01 ~ 0.79	0.09	0.00 ~ 0.36	0.12	0.00 ~ 0.36
30dB (10 samples)	0.55	0.33 ~ 0.76	0.60	0.35 ~ 0.91	0.36	0.12 ~ 0.64	0.42	0.21 ~ 0.59

■ Max COM (actual) – Baseline COM

Zc (nominal)	100Ω				93Ω			
zp	12mm		30mm		12mm		30mm	
channel loss	avg	min ~ max	avg	min ~ max	avg	min ~ max	avg	min ~ max
10dB (8 samples)	0.48	0.20 ~ 0.65	0.52	0.32 ~ 0.66	0.81	0.46 ~ 1.12	0.80	0.50 ~ 1.06
20dB (10 samples)	0.26	0.00 ~ 0.59	0.27	0.13 ~ 0.45	0.44	0.12 ~ 0.81	0.44	0.22 ~ 0.63
30dB (10 samples)	0.24	0.11 ~ 0.36	0.31	0.21 ~ 0.42	0.34	0.14 ~ 0.65	0.42	0.27 ~ 0.65

■ For simplicity, I squeeze only channel and Rx in a fair manner

- More study is needed to squeeze Tx

Fairly Revised Worst Common Spec for Option 1

■ For Z_c (nominal) = 100Ω

■ For Z_c (nominal) = 93Ω

■ Worst common = 2.85dB

■ Worst common = 3.0dB

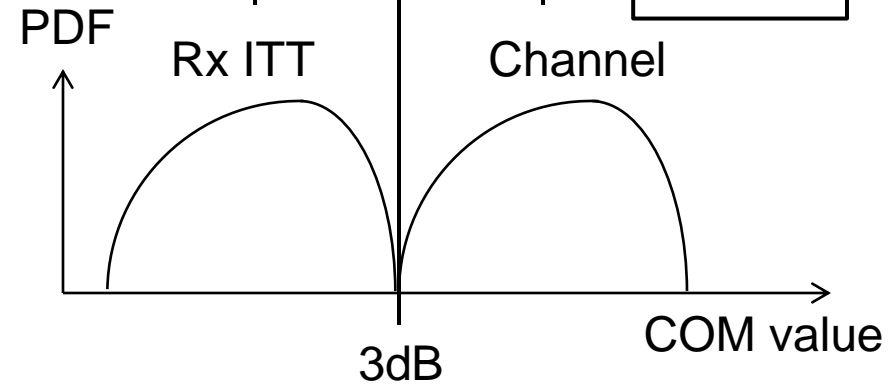
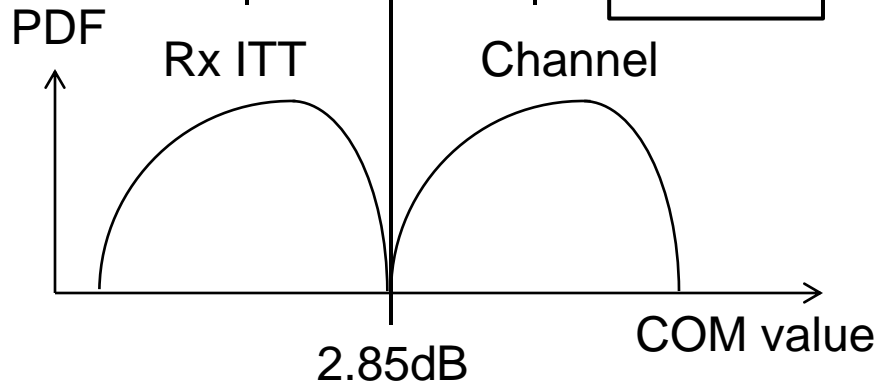
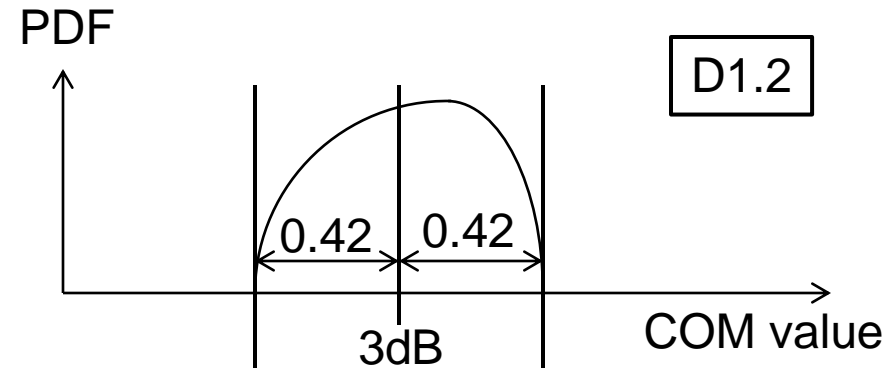
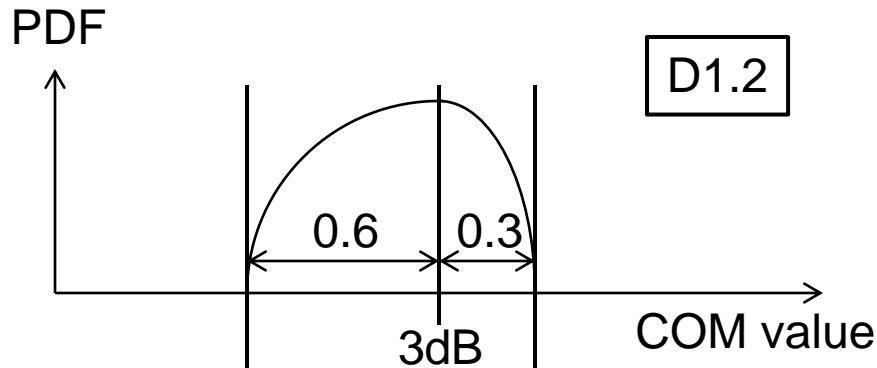

worst COM spec
(common)

worst COM spec
(common)

Fairly Revised Typ COM Spec for Option 2

■ For Z_c (nominal) = 100Ω

■ For Z_c (nominal) = 93Ω

■ Typ Channel = 3.45dB

■ Typ Channel = 3.6dB

■ Typ Rx ITT = 2.55dB

■ Typ Rx ITT = 2.7dB

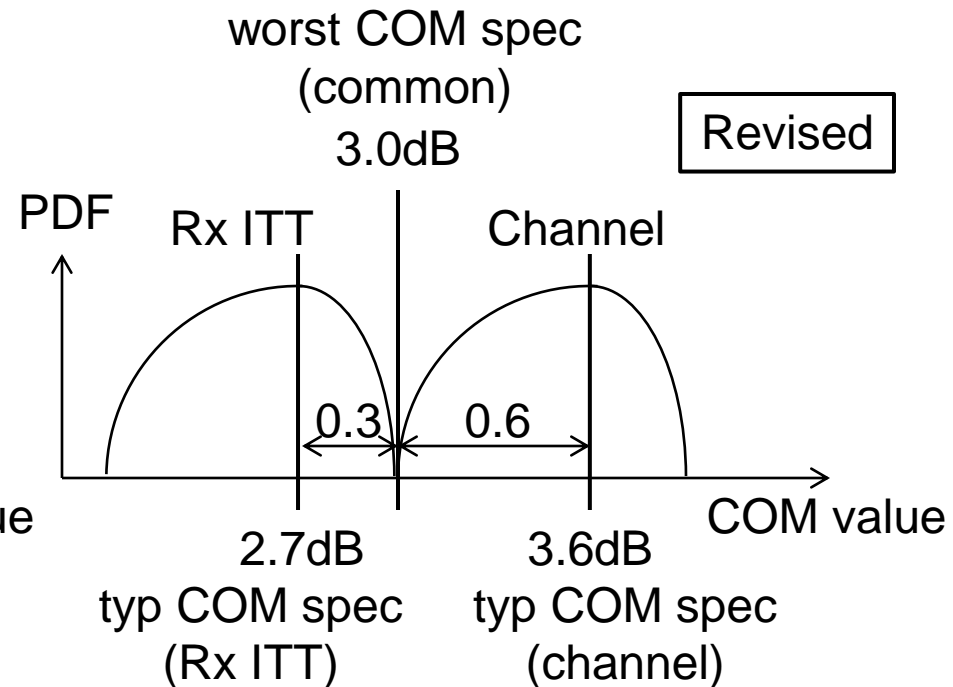
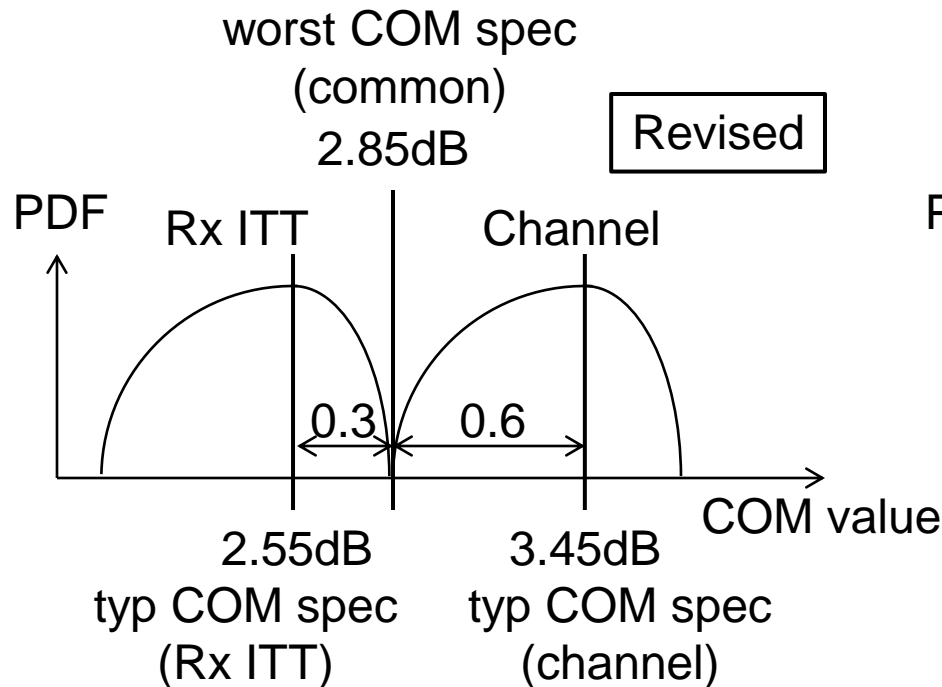

- Many COM parameters are in the worst condition
- Testing all of them in the worst condition may be pessimistic, because the probability of such condition is very low
- Since we have COM tests for two components, we may relax the COM spec of each component by allowing overlap of probability distribution by a factor of $1 - \frac{\sqrt{2}}{2} \approx 0.3$ of variation
- For option 2, this can be done by changing X and Y as follows
 - Change X (offset for channel) from 0.6dB to 0.4dB
 - Change Y (offset for Rx ITT) from 0.3dB to 0.2dB
- For option 1, this can be done by differentiating the worst COM spec value between channel and Rx ITT accordingly
 - Now, option 1 also has the risk of depending on the inaccurate distribution
 - This is natural, because we now relax the worst-condition test in option 1 as well

Relaxed COM Spec by Overlap of Distribution

■ For Z_c (nominal) = 100Ω

- Worst Channel = 2.65dB
- Worst Rx ITT = 2.95dB
- Typ Channel = 3.25dB
- Typ Rx ITT = 2.65dB

■ For Z_c (nominal) = 93Ω

- Worst Channel = 2.8dB
- Worst Rx ITT = 3.1dB
- Typ Channel = 3.4dB
- Typ Rx ITT = 2.8dB

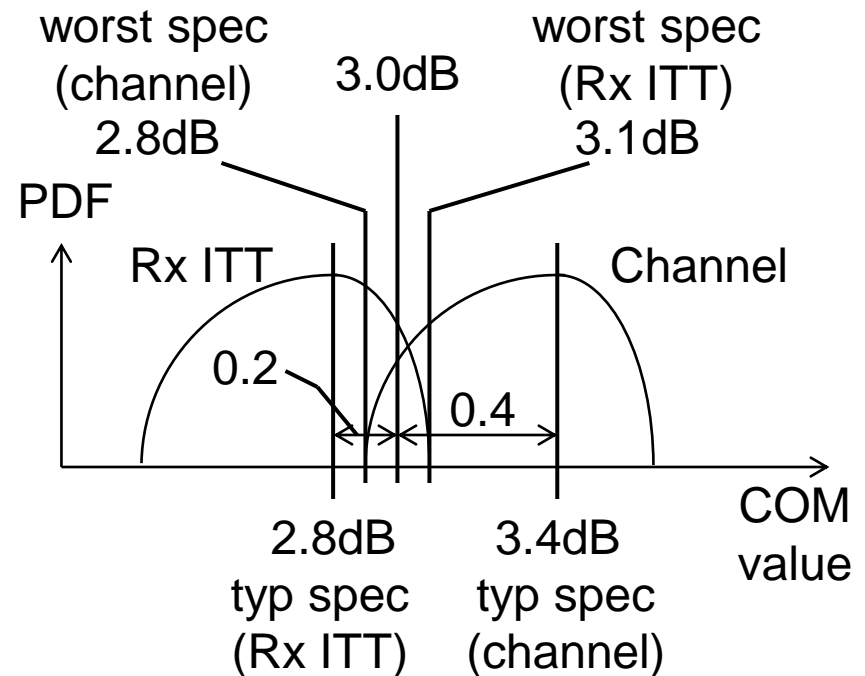
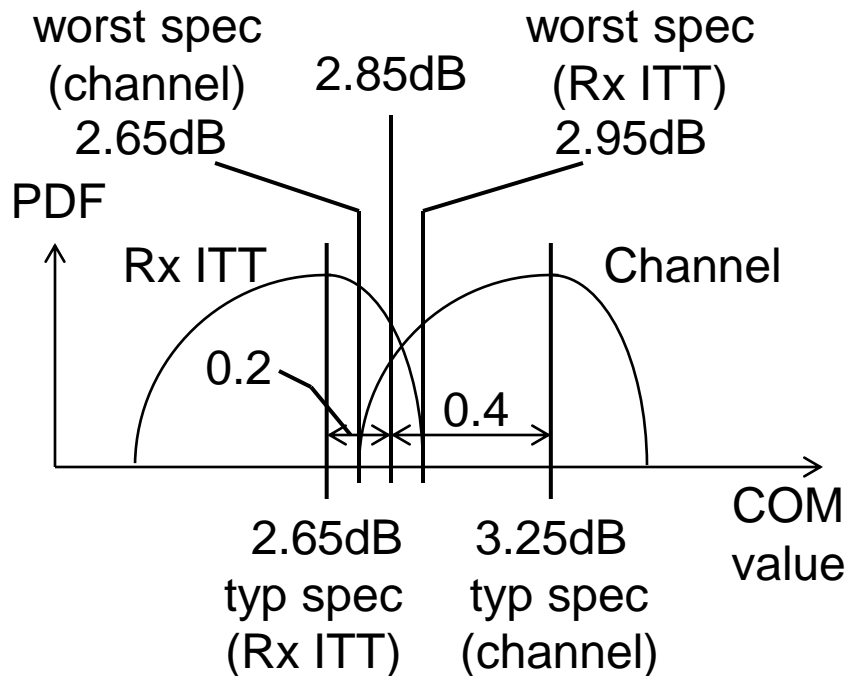

■ There are many options

■ Options for the worst-condition test of COM

1. Estimate the worst (min for channel, max for Rx ITT) COM (complex, low risk)
2. Test in the typical condition and offset the COM spec value (simple, high risk)

■ Options for relaxing the COM spec

- a) Relax the COM spec by allowing overlap of distribution (high risk)
- b) Do not relax the COM spec by allowing overlap of distribution (low risk)

■ Options for nominal values of Z_c

- i. $Z_c = 100\Omega$
- ii. $Z_c = 93\Omega$

■ Options how to squeeze the margin for interaction of impedance

- A. Squeeze channel and Rx
- B. Squeeze channel, Rx, and Tx (not covered by this presentation)

■ I provided revised COM values for all combinations with A

■ More study is need for option B

■ Options for the worst-condition test of COM

1. Efficiently estimate the worst (min for channel, max for Rx ITT) COM
2. Test in the typical condition and offset the COM spec value
3. Do not introduce the worst-condition test of COM (no change)
4. Need more information

■ Options for relaxing the COM spec

- a) Relax the COM spec by allowing overlap of distribution as presented
- b) Relax the COM spec in some other way (e.g. overlap half distribution)
- c) Do not relax the COM spec by allowing overlap of distribution
- d) Need more information

■ Options for nominal values of Z_c

- i. $Z_c = 100\Omega$
- ii. $Z_c = 93\Omega$
- iii. Some other value
- iv. Need more information

- Options how to squeeze the margin for interaction of impedance
 - A. Squeeze channel and Rx
 - B. Squeeze channel, Rx, and Tx
 - C. Some other choice (e.g. only channel, only Rx, only Tx, etc)
 - D. Need more information

Back up Slides

- Baseline/Min/Max/Typ COM Results
- COM Parameters
- Channel Data Source

BL/Min/Max/Typ COM for zp=12mm, Zc=100Ω



Loss	Channel Type	CH #	Baseline COM (zp=12)				Min COM (zp=12)						Max COM (zp=12)						Typ COM (zp=12)						Difference		
			TC #	Tx Rd	Tx Zc	COM	TC #	Tx Rd	Tx Zc	Rx Rd	Rx Zc	Min COM	TC #	Tx Rd	Tx Zc	Rx Rd	Rx Zc	Max COM	TC #	Tx Rd	Tx Zc	Rx Rd	Rx Zc	Typ COM	Typ COM - Min COM	Max COM - Typ COM	Max COM - Min COM
10dB	Cisco	CH1	TC11	55	90	5.31	TC11	55	90	55	90	5.31	TC15	55	110	55	90	5.96	OC1	50	100	50	100	5.82	0.51	0.14	0.65
	TE	CH41	TC11	55	90	6.87	TC8	45	110	55	110	6.81	TC3	45	90	55	90	7.22	OC1	50	100	50	100	7.18	0.36	0.05	0.41
	Intel 100Ω	CH11	TC11	55	90	5.07	TC6	45	110	45	110	4.66	TC3	45	90	55	90	5.48	OC1	50	100	50	100	5.21	0.54	0.27	0.82
		CH12	TC11	55	90	5.12	TC13	55	110	45	90	4.99	TC3	45	90	55	90	5.70	OC1	50	100	50	100	5.55	0.57	0.15	0.72
		CH13	TC11	55	90	4.17	TC6	45	110	45	110	3.86	TC3	45	90	55	90	4.74	OC1	50	100	50	100	4.39	0.53	0.35	0.89
	Intel 85Ω	CH26	TC11	55	90	7.36	TC6	45	110	45	110	6.32	TC3	45	90	55	90	7.56	OC1	50	100	50	100	7.20	0.89	0.35	1.24
		CH27	TC11	55	90	6.42	TC6	45	110	45	110	5.91	TC3	45	90	55	90	6.96	OC1	50	100	50	100	6.67	0.76	0.29	1.05
		CH28	TC11	55	90	6.28	TC14	55	110	45	110	5.37	TC3	45	90	55	90	6.84	OC1	50	100	50	100	6.32	0.95	0.52	1.47
	Average																							0.64	0.27	0.91	
20dB	Cisco	CH4	TC11	55	90	5.49	TC11	55	90	55	90	5.49	TC12	55	90	55	110	6.08	OC1	50	100	50	100	6.01	0.52	0.07	0.59
	TE	CH42	TC11	55	90	5.20	TC11	55	90	55	90	5.20	TC12	55	90	55	110	5.53	OC1	50	100	50	100	5.45	0.25	0.08	0.33
	Intel 100Ω	CH17	TC11	55	90	6.17	TC8	45	110	55	110	5.85	TC3	45	90	55	90	6.40	OC1	50	100	50	100	6.27	0.41	0.14	0.55
		CH18	TC11	55	90	5.52	TC8	45	110	55	110	5.25	TC3	45	90	55	90	5.96	OC1	50	100	50	100	5.70	0.45	0.26	0.70
		CH19	TC11	55	90	5.85	TC6	45	110	45	110	5.27	TC11	55	90	55	90	6.08	OC1	50	100	50	100	5.87	0.60	0.21	0.81
	Intel 85Ω	CH32	TC11	55	90	7.02	TC4	45	90	55	110	6.69	TC3	45	90	55	90	7.22	OC1	50	100	50	100	7.08	0.39	0.14	0.53
		CH33	TC11	55	90	6.42	TC8	45	110	55	110	6.06	TC3	45	90	55	90	6.72	OC1	50	100	50	100	6.48	0.43	0.23	0.66
		CH34	TC11	55	90	6.47	TC4	45	90	55	110	5.88	TC11	55	90	55	90	6.64	OC1	50	100	50	100	6.41	0.53	0.23	0.75
	Cavium	CH44	TC11	55	90	3.90	TC6	45	110	45	110	3.80	TC12	55	90	55	110	4.02	OC1	50	100	50	100	3.99	0.19	0.03	0.22
		CH45	TC11	55	90	4.20	TC6	45	110	45	110	3.97	TC13	55	110	45	90	4.20	OC1	50	100	50	100	4.13	0.16	0.07	0.23
Average																							0.39	0.15	0.54		
30dB	Cisco	CH8	TC11	55	90	3.84	TC4	45	90	55	110	3.36	TC12	55	90	55	110	4.19	OC1	50	100	50	100	3.94	0.58	0.25	0.83
	TE	CH43	TC11	55	90	2.21	TC8	45	110	55	110	1.88	TC12	55	90	55	110	2.49	OC1	50	100	50	100	2.26	0.37	0.23	0.60
	Intel 100Ω	CH23	TC11	55	90	3.60	TC8	45	110	55	110	3.14	TC11	55	90	55	90	3.88	OC1	50	100	50	100	3.57	0.43	0.31	0.74
		CH24	TC11	55	90	3.30	TC8	45	110	55	110	2.85	TC12	55	90	55	110	3.57	OC1	50	100	50	100	3.38	0.52	0.19	0.72
		CH25	TC11	55	90	3.54	TC8	45	110	55	110	2.82	TC11	55	90	55	90	3.78	OC1	50	100	50	100	3.40	0.58	0.38	0.96
	Intel 85Ω	CH38	TC11	55	90	4.31	TC4	45	90	55	110	3.73	TC11	55	90	55	90	4.50	OC1	50	100	50	100	4.25	0.52	0.24	0.77
		CH39	TC11	55	90	3.89	TC8	45	110	55	110	3.34	TC11	55	90	55	90	4.14	OC1	50	100	50	100	3.89	0.55	0.25	0.80
		CH40	TC11	55	90	4.08	TC4	45	90	55	110	3.32	TC11	55	90	55	90	4.28	OC1	50	100	50	100	3.92	0.59	0.36	0.95
	Cavium	CH46	TC11	55	90	3.90	TC8	45	110	55	110	3.30	TC11	55	90	55	90	4.10	OC1	50	100	50	100	3.77	0.47	0.33	0.80
		CH47	TC11	55	90	3.97	TC8	45	110	55	110	3.39	TC11	55	90	55	90	4.08	OC1	50	100	50	100	3.82	0.43	0.26	0.69
Average																							0.51	0.28	0.79		

BL/Min/Max/Typ COM for zp=30mm, Zc=100Ω



Loss	Channel Type	CH #	Baseline COM (zp=30)				Min COM (zp=30)					Max COM_A (zp=30)					Typ COM (zp=30)					Difference					
			TC #	Tx Rd	Tx Rx	Zc	COM	TC #	Tx Rd	Tx Zc	Rx Rd	Rx Zc	Min COM	TC #	Tx Rd	Tx Zc	Rx Rd	Rx Zc	Max COM	TC #	Tx Rd	Tx Zc	Rx Rd	Rx Zc	Typ COM	Typ COM - Min COM	Max COM - Typ COM
10dB	Cisco	CH1	TC27	55	90	5.71	TC24	45	110	55	110	5.69	TC28	55	90	55	110	6.20	OC2	50	100	50	100	6.09	0.40	0.11	0.51
	TE	CH41	TC27	55	90	6.58	TC32	55	110	55	110	6.51	TC19	45	90	55	90	6.89	OC2	50	100	50	100	6.74	0.23	0.15	0.38
	Intel 100Ω	CH11	TC27	55	90	5.08	TC22	45	110	45	110	4.58	TC19	45	90	55	90	5.55	OC2	50	100	50	100	5.17	0.60	0.38	0.98
		CH12	TC27	55	90	5.13	TC22	45	110	45	110	4.88	TC19	45	90	55	90	5.79	OC2	50	100	50	100	5.55	0.66	0.24	0.90
		CH13	TC27	55	90	4.28	TC22	45	110	45	110	3.88	TC19	45	90	55	90	4.88	OC2	50	100	50	100	4.47	0.60	0.40	1.00
	Intel 85Ω	CH26	TC27	55	90	7.14	TC22	45	110	45	110	6.45	TC19	45	90	55	90	7.50	OC2	50	100	50	100	7.15	0.70	0.35	1.05
		CH27	TC27	55	90	6.41	TC22	45	110	45	110	5.89	TC19	45	90	55	90	7.01	OC2	50	100	50	100	6.65	0.75	0.36	1.11
		CH28	TC27	55	90	6.41	TC30	55	110	45	110	5.70	TC19	45	90	55	90	7.06	OC2	50	100	50	100	6.59	0.89	0.47	1.36
	Average																							0.60	0.31	0.91	
20dB	Cisco	CH4	TC27	55	90	5.43	TC24	45	110	55	110	5.27	TC28	55	90	55	110	5.83	OC2	50	100	50	100	5.66	0.39	0.17	0.56
	TE	CH42	TC27	55	90	4.60	TC24	45	110	55	110	4.54	TC27	55	90	55	90	4.88	OC2	50	100	50	100	4.78	0.24	0.11	0.34
	Intel 100Ω	CH17	TC27	55	90	5.78	TC22	45	110	45	110	5.22	TC19	45	90	55	90	6.06	OC2	50	100	50	100	5.82	0.60	0.23	0.83
		CH18	TC27	55	90	5.18	TC24	45	110	55	110	4.88	TC19	45	90	55	90	5.63	OC2	50	100	50	100	5.39	0.51	0.24	0.75
		CH19	TC27	55	90	5.24	TC22	45	110	45	110	4.45	TC19	45	90	55	90	5.40	OC2	50	100	50	100	5.18	0.73	0.22	0.95
	Intel 85Ω	CH32	TC27	55	90	6.68	TC24	45	110	55	110	6.09	TC27	55	90	55	90	6.81	OC2	50	100	50	100	6.65	0.56	0.16	0.72
		CH33	TC27	55	90	6.14	TC24	45	110	55	110	5.61	TC19	45	90	55	90	6.39	OC2	50	100	50	100	6.16	0.55	0.22	0.77
		CH34	TC27	55	90	6.04	TC22	45	110	45	110	5.32	TC27	55	90	55	90	6.18	OC2	50	100	50	100	5.93	0.61	0.24	0.86
	Cavium	CH44	TC27	55	90	3.13	TC19	45	90	55	90	3.12	TC32	55	110	55	110	3.49	OC2	50	100	50	100	3.39	0.27	0.10	0.37
		CH45	TC27	55	90	3.32	TC19	45	90	55	90	3.24	TC32	55	110	55	110	3.58	OC2	50	100	50	100	3.52	0.28	0.07	0.35
Average																							0.47	0.18	0.65		
30dB	Cisco	CH8	TC27	55	90	3.01	TC20	45	90	55	110	2.46	TC28	55	90	55	110	3.39	OC2	50	100	50	100	3.06	0.60	0.33	0.92
	TE	CH43	TC27	55	90	1.33	TC19	45	90	55	90	0.98	TC28	55	90	55	110	1.67	OC2	50	100	50	100	1.37	0.39	0.30	0.69
	Intel 100Ω	CH23	TC27	55	90	2.73	TC24	45	110	55	110	2.01	TC27	55	90	55	90	3.00	OC2	50	100	50	100	2.65	0.64	0.35	0.98
		CH24	TC27	55	90	2.45	TC24	45	110	55	110	1.92	TC27	55	90	55	90	2.75	OC2	50	100	50	100	2.48	0.56	0.27	0.83
		CH25	TC27	55	90	2.59	TC24	45	110	55	110	1.68	TC27	55	90	55	90	2.81	OC2	50	100	50	100	2.41	0.73	0.40	1.12
	Intel 85Ω	CH38	TC27	55	90	3.41	TC24	45	110	55	110	2.70	TC27	55	90	55	90	3.62	OC2	50	100	50	100	3.34	0.64	0.29	0.92
		CH39	TC27	55	90	3.00	TC24	45	110	55	110	2.42	TC10	55	90	45	110	3.34	OC2	50	100	50	100	3.00	0.58	0.34	0.92
		CH40	TC27	55	90	3.22	TC24	45	110	55	110	2.37	TC27	55	90	55	90	3.47	OC2	50	100	50	100	3.07	0.70	0.39	1.09
	Cavium	CH46	TC27	55	90	3.02	TC20	45	90	55	110	2.63	TC28	55	90	55	110	3.44	OC2	50	100	50	100	3.16	0.53	0.28	0.81
		CH47	TC27	55	90	3.01	TC20	45	90	55	110	2.60	TC28	55	90	55	110	3.40	OC2	50	100	50	100	3.14	0.53	0.27	0.80
Average																							0.59	0.32	0.91		

BL/Min/Max/Typ COM for zp=12mm, Zc=93Ω



Loss	Channel Type	CH #	Baseline COM (zp=12)				Min COM (zp=12)						Max COM (zp=12)						Typ COM (zp=12)						Difference		
			TC #	Tx Rd	Tx Rx	Zc	COM	TC #	Tx Rd	Tx Zc	Rx Rd	Rx Zc	Min COM	TC #	Tx Rd	Tx Zc	Rx Rd	Rx Zc	Max COM	TC #	Tx Rd	Tx Zc	Rx Rd	Rx Zc	Typ COM	Typ COM - Min COM	Max COM - Typ COM
10dB	Cisco	CH1	TC11	55	83.7	4.84	TC11	55	83.7	55	83.7	4.84	TC14	55	102.3	45	102.3	5.92	OC1	50	93	50	93	5.73	0.89	0.18	1.08
	TE	CH41	TC11	55	83.7	6.46	TC11	55	83.7	55	83.7	6.46	TC2	45	83.7	45	102.3	7.24	OC1	50	93	50	93	7.19	0.73	0.05	0.78
	Intel 100Ω	CH11	TC11	55	83.7	4.83	TC11	55	83.7	55	83.7	4.83	TC1	45	83.7	45	83.7	5.51	OC1	50	93	50	93	5.32	0.49	0.19	0.68
		CH12	TC11	55	83.7	4.65	TC11	55	83.7	55	83.7	4.65	TC2	45	83.7	45	102.3	5.78	OC1	50	93	50	93	5.59	0.94	0.19	1.12
		CH13	TC11	55	83.7	3.93	TC11	55	83.7	55	83.7	3.93	TC1	45	83.7	45	83.7	4.68	OC1	50	93	50	93	4.53	0.61	0.15	0.75
	Intel 85Ω	CH26	TC11	55	83.7	7.23	TC6	45	102.3	45	102.3	6.94	TC1	45	83.7	45	83.7	7.68	OC1	50	93	50	93	7.51	0.57	0.18	0.75
		CH27	TC11	55	83.7	6.11	TC11	55	83.7	55	83.7	6.11	TC1	45	83.7	45	83.7	6.94	OC1	50	93	50	93	6.83	0.72	0.11	0.82
		CH28	TC11	55	83.7	6.14	TC14	55	102.3	45	102.3	5.97	TC1	45	83.7	45	83.7	6.94	OC1	50	93	50	93	6.64	0.66	0.31	0.97
	Average																							0.70	0.17	0.87	
20dB	Cisco	CH4	TC11	55	83.7	5.19	TC11	55	83.7	55	83.7	5.19	TC14	55	102.3	45	102.3	6.00	OC1	50	93	50	93	5.83	0.65	0.16	0.81
	TE	CH42	TC11	55	83.7	5.02	TC11	55	83.7	55	83.7	5.02	TC2	45	83.7	45	102.3	5.55	OC1	50	93	50	93	5.46	0.44	0.09	0.53
	Intel 100Ω	CH17	TC11	55	83.7	5.97	TC11	55	83.7	55	83.7	5.97	TC1	45	83.7	45	83.7	6.40	OC1	50	93	50	93	6.27	0.30	0.13	0.43
		CH18	TC11	55	83.7	5.36	TC11	55	83.7	55	83.7	5.36	TC1	45	83.7	45	83.7	5.95	OC1	50	93	50	93	5.76	0.39	0.19	0.58
		CH19	TC11	55	83.7	5.67	TC4	45	83.7	55	102.3	5.53	TC13	55	102.3	45	83.7	6.10	OC1	50	93	50	93	5.99	0.46	0.11	0.56
	Intel 85Ω	CH32	TC11	55	83.7	6.94	TC4	45	83.7	55	102.3	6.76	TC1	45	83.7	45	83.7	7.25	OC1	50	93	50	93	7.14	0.38	0.11	0.49
		CH33	TC11	55	83.7	6.33	TC15	55	102.3	55	83.7	6.21	TC1	45	83.7	45	83.7	6.78	OC1	50	93	50	93	6.59	0.38	0.19	0.57
		CH34	TC11	55	83.7	6.32	TC4	45	83.7	55	102.3	5.96	TC1	45	83.7	45	83.7	6.69	OC1	50	93	50	93	6.57	0.61	0.13	0.73
	Cavium	CH44	TC11	55	83.7	3.71	TC11	55	83.7	55	83.7	3.71	TC14	55	102.3	45	102.3	4.02	OC1	50	93	50	93	3.99	0.28	0.03	0.32
		CH45	TC11	55	83.7	4.05	TC4	45	83.7	55	102.3	3.97	TC15	55	102.3	55	83.7	4.17	OC1	50	93	50	93	4.12	0.16	0.05	0.21
Average																							0.41	0.12	0.52		
30dB	Cisco	CH8	TC11	55	83.7	3.58	TC3	45	83.7	55	83.7	3.36	TC14	55	102.3	45	102.3	4.24	OC1	50	93	50	93	3.92	0.55	0.32	0.87
	TE	CH43	TC11	55	83.7	2.08	TC3	45	83.7	55	83.7	1.84	TC10	55	83.7	45	102.3	2.45	OC1	50	93	50	93	2.24	0.40	0.22	0.61
	Intel 100Ω	CH23	TC11	55	83.7	3.50	TC8	45	102.3	55	102.3	3.24	TC10	55	83.7	45	102.3	3.86	OC1	50	93	50	93	3.66	0.43	0.20	0.63
		CH24	TC11	55	83.7	3.14	TC8	45	102.3	55	102.3	3.01	TC10	55	83.7	45	102.3	3.57	OC1	50	93	50	93	3.38	0.36	0.19	0.56
		CH25	TC11	55	83.7	3.50	TC4	45	83.7	55	102.3	3.02	TC9	55	83.7	45	83.7	3.78	OC1	50	93	50	93	3.52	0.49	0.26	0.76
	Intel 85Ω	CH38	TC11	55	83.7	4.24	TC4	45	83.7	55	102.3	3.80	TC9	55	83.7	45	83.7	4.50	OC1	50	93	50	93	4.32	0.53	0.17	0.70
		CH39	TC11	55	83.7	3.84	TC4	45	83.7	55	102.3	3.52	TC10	55	83.7	45	102.3	4.19	OC1	50	93	50	93	3.97	0.45	0.22	0.68
		CH40	TC11	55	83.7	4.03	TC4	45	83.7	55	102.3	3.39	TC9	55	83.7	45	83.7	4.29	OC1	50	93	50	93	4.04	0.65	0.25	0.91
	Cavium	CH46	TC11	55	83.7	3.77	TC8	45	102.3	55	102.3	3.43	TC10	55	83.7	45	102.3	4.10	OC1	50	93	50	93	3.89	0.46	0.21	0.67
		CH47	TC11	55	83.7	3.96	TC8	45	102.3	55	102.3	3.44	TC9	55	83.7	45	83.7	4.10	OC1	50	93	50	93	3.86	0.42	0.23	0.66
Average																							0.48	0.23	0.70		

BL/Min/Max/Typ COM for zp=30mm, Zc=93Ω



Loss	Channel Type	CH #	Baseline COM (zp=30)				Min COM (zp=30)						Max COM_A (zp=30)						Typ COM (zp=30)						Difference		
			TC #	Tx Rd	Tx Rx	Zc	COM	TC #	Tx Rd	Tx Zc	Rx Rd	Rx Zc	Min COM	TC #	Tx Rd	Tx Zc	Rx Rd	Rx Zc	Max COM	TC #	Tx Rd	Tx Zc	Rx Rd	Rx Zc	Typ COM	Typ COM - Min COM	Max COM - Typ COM
10dB	Cisco	CH1	TC27	55	83.7	5.28	TC27	55	83.7	55	83.7	5.28	TC29	55	102.3	45	83.7	6.21	OC2	50	93	50	93	6.09	0.82	0.12	0.93
	TE	CH41	TC27	55	83.7	6.28	TC27	55	83.7	55	83.7	6.28	TC18	45	83.7	45	102.3	6.86	OC2	50	93	50	93	6.79	0.51	0.07	0.58
	Intel 100Ω	CH11	TC27	55	83.7	4.82	TC27	55	83.7	55	83.7	4.82	TC17	45	83.7	45	83.7	5.55	OC2	50	93	50	93	5.35	0.53	0.20	0.73
		CH12	TC27	55	83.7	4.70	TC27	55	83.7	55	83.7	4.70	TC18	45	83.7	45	102.3	5.76	OC2	50	93	50	93	5.61	0.91	0.15	1.06
		CH13	TC27	55	83.7	3.98	TC27	55	83.7	55	83.7	3.98	TC17	45	83.7	45	83.7	4.88	OC2	50	93	50	93	4.68	0.70	0.20	0.90
	Intel 85Ω	CH26	TC27	55	83.7	7.02	TC29	55	102.3	45	83.7	6.89	TC17	45	83.7	45	83.7	7.52	OC2	50	93	50	93	7.33	0.44	0.19	0.63
		CH27	TC27	55	83.7	6.14	TC27	55	83.7	55	83.7	6.14	TC17	45	83.7	45	83.7	6.93	OC2	50	93	50	93	6.76	0.63	0.16	0.79
		CH28	TC27	55	83.7	6.19	TC31	55	102.3	55	83.7	6.18	TC17	45	83.7	45	83.7	7.07	OC2	50	93	50	93	6.79	0.60	0.29	0.89
	Average																							0.64	0.17	0.81	
20dB	Cisco	CH4	TC27	55	83.7	5.15	TC27	55	83.7	55	83.7	5.15	TC30	55	102.3	45	102.3	5.78	OC2	50	93	50	93	5.58	0.43	0.20	0.63
	TE	CH42	TC27	55	83.7	4.52	TC27	55	83.7	55	83.7	4.52	TC18	45	83.7	45	102.3	4.90	OC2	50	93	50	93	4.72	0.19	0.18	0.37
	Intel 100Ω	CH17	TC27	55	83.7	5.62	TC22	45	102.3	45	102.3	5.55	TC17	45	83.7	45	83.7	6.05	OC2	50	93	50	93	5.93	0.39	0.11	0.50
		CH18	TC27	55	83.7	4.97	TC27	55	83.7	55	83.7	4.97	TC17	45	83.7	45	83.7	5.60	OC2	50	93	50	93	5.43	0.46	0.16	0.62
		CH19	TC27	55	83.7	5.05	TC22	45	102.3	45	102.3	4.82	TC17	45	83.7	45	83.7	5.55	OC2	50	93	50	93	5.43	0.61	0.11	0.73
	Intel 85Ω	CH32	TC27	55	83.7	6.61	TC20	45	83.7	55	102.3	6.25	TC17	45	83.7	45	83.7	6.83	OC2	50	93	50	93	6.76	0.51	0.07	0.58
		CH33	TC27	55	83.7	6.06	TC20	45	83.7	55	102.3	5.88	TC17	45	83.7	45	83.7	6.45	OC2	50	93	50	93	6.25	0.37	0.20	0.57
		CH34	TC27	55	83.7	5.78	TC20	45	83.7	55	102.3	5.56	TC17	45	83.7	45	83.7	6.20	OC2	50	93	50	93	6.16	0.60	0.04	0.63
	Cavium	CH44	TC27	55	83.7	2.97	TC27	55	83.7	55	83.7	2.97	TC30	55	102.3	45	102.3	3.43	OC2	50	93	50	93	3.28	0.30	0.15	0.46
CH45		TC27	55	83.7	3.23	TC19	45	83.7	55	83.7	3.12	TC30	55	102.3	45	102.3	3.56	OC2	50	93	50	93	3.36	0.24	0.20	0.43	
Average																							0.41	0.14	0.55		
30dB	Cisco	CH8	TC27	55	83.7	2.84	TC19	45	83.7	55	83.7	2.45	TC30	55	102.3	45	102.3	3.45	OC2	50	93	50	93	3.00	0.55	0.45	1.00
	TE	CH43	TC27	55	83.7	1.26	TC19	45	83.7	55	83.7	0.94	TC26	55	83.7	45	102.3	1.68	OC2	50	93	50	93	1.39	0.45	0.29	0.74
	Intel 100Ω	CH23	TC27	55	83.7	2.70	TC24	45	102.3	55	102.3	2.24	TC26	55	83.7	45	102.3	2.97	OC2	50	93	50	93	2.72	0.49	0.25	0.74
		CH24	TC27	55	83.7	2.32	TC19	45	83.7	55	83.7	2.10	TC26	55	83.7	45	102.3	2.81	OC2	50	93	50	93	2.56	0.45	0.25	0.70
		CH25	TC27	55	83.7	2.51	TC24	45	102.3	55	102.3	1.99	TC25	55	83.7	45	83.7	2.79	OC2	50	93	50	93	2.55	0.55	0.25	0.80
	Intel 85Ω	CH38	TC27	55	83.7	3.39	TC20	45	83.7	55	102.3	2.79	TC25	55	83.7	45	83.7	3.66	OC2	50	93	50	93	3.36	0.57	0.30	0.87
		CH39	TC27	55	83.7	2.94	TC20	45	83.7	55	102.3	2.56	TC26	55	83.7	45	102.3	3.32	OC2	50	93	50	93	3.06	0.50	0.26	0.77
		CH40	TC27	55	83.7	3.09	TC20	45	83.7	55	102.3	2.51	TC4	45	83.7	55	102.3	3.39	OC2	50	93	50	93	3.16	0.65	0.23	0.88
	Cavium	CH46	TC27	55	83.7	2.83	TC19	45	83.7	55	83.7	2.50	TC26	55	83.7	45	102.3	3.48	OC2	50	93	50	93	3.15	0.65	0.33	0.98
CH47		TC27	55	83.7	2.91	TC19	45	83.7	55	83.7	2.49	TC30	55	102.3	45	102.3	3.43	OC2	50	93	50	93	3.07	0.59	0.35	0.94	
Average																							0.54	0.30	0.84		

COM Parameters for typ $Z_c = 100\Omega$

Condition #		TC1	TC2	TC3	TC4	TC5	TC6	TC7	TC8	TC9	TC10	TC11	TC12	TC13	TC14	TC15	TC16	OC1	
zp	Tx	Victim																12	
		FEXT																12	
		NEXT																12	
	Rx																12		
Rd	Tx (Victim, XT)		45								55								50
	Rx		45		55		45		55		45		55		45		55		50
Zc	Tx (Victim, XT)		90				110				90				110				100
	Rx		90	110	90	110	90	110	90	110	90	110	90	110	90	110	90	110	100
Av		0.394								0.436								0.415	
Afe		0.394								0.436								0.415	
Ane		0.581								0.642								0.611	

TC#		TC17	TC18	TC19	TC20	TC21	TC22	TC23	TC24	TC25	TC26	TC27	TC28	TC29	TC30	TC31	TC32	OC2	
zp	Tx	Victim																30	
		FEXT																30	
		NEXT																12	
	Rx																30		
Rd	Tx (Victim, XT)		45								55								50
	Rx		45		55		45		55		45		55		45		55		50
Zc	Tx (Victim, XT)		90				110				90				110				93
	Rx		90	110	90	110	90	110	90	110	90	110	90	110	90	110	90	110	93
Av		0.394								0.436								0.415	
Afe		0.394								0.436								0.415	
Ane		0.581								0.642								0.611	

COM Parameters for typ $Z_c = 93\Omega$

Condition #		TC1	TC2	TC3	TC4	TC5	TC6	TC7	TC8	TC9	TC10	TC11	TC12	TC13	TC14	TC15	TC16	OC1	
zp	Tx	Victim																12	
		FEXT																12	
		NEXT																12	
	Rx																12		
Rd	Tx (Victim, XT)		45								55								50
	Rx		45		55		45		55		45		55		45		55		50
Zc	Tx (Victim, XT)		83.7				102.3				83.7				102.3				93
	Rx		83.7	102.3	83.7	102.3	83.7	102.3	83.7	102.3	83.7	102.3	83.7	102.3	83.7	102.3	83.7	102.3	93
Av		0.394								0.436								0.415	
Afe		0.394								0.436								0.415	
Ane		0.581								0.642								0.611	

TC#		TC17	TC18	TC19	TC20	TC21	TC22	TC23	TC24	TC25	TC26	TC27	TC28	TC29	TC30	TC31	TC32	OC2	
zp	Tx	Victim																30	
		FEXT																30	
		NEXT																12	
	Rx																30		
Rd	Tx (Victim, XT)		45								55								50
	Rx		45		55		45		55		45		55		45		55		50
Zc	Tx (Victim, XT)		83.7				102.3				83.7				102.3				93
	Rx		83.7	102.3	83.7	102.3	83.7	102.3	83.7	102.3	83.7	102.3	83.7	102.3	83.7	102.3	83.7	102.3	93
Av		0.394								0.436								0.415	
Afe		0.394								0.436								0.415	
Ane		0.581								0.642								0.611	

The Other COM Parameters

Table 93A-1 parameters			
Parameter	Setting	Units	Information
f_b	26.5625	GBd	
f_min	0.05	GHz	
Delta_f	0.01	GHz	
C_d	[1.8e-4 1.8e-4]	nF	[TX RX]
z_p select	[1]		[test cases to run]
z_p (TX)	[30]	mm	[test cases]
z_p (NEXT)	[12]	mm	[test cases]
z_p (FEXT)	[30]	mm	[test cases]
z_p (RX)	[30]	mm	[test cases]
C_p	[1.1e-4 1.1e-4]	nF	[TX RX]
R_0	50	Ohm	
R_d	[55 45]	Ohm	tdr selected
f_r	0.75	*fb	
c(0)	0.6		min
c(-1)	[-0.25:0.05:0]		[min:step:max]
c(-2)	[0:0.025:0.1]		[min:step:max]
c(1)	[-0.25:0.05:0]		[min:step:max]
g_DC	[-20:1:0]	dB	[min:step:max]
f_z	10.625	GHz	
f_p1	10.625	GHz	
f_p2	1.00E+99	GHz	
A_v	[0.39357 0.436]	V	tdr selected
A_fe	[0.39357 0.436]	V	tdr selected
A_ne	[0.5754 0.636]	V	tdr selected
L	4		
M	32		
N_b	12	UI	
b_max(1)	0.7		
b_max(2..N_b)	0.2		
sigma_RJ	0.01	UI	
A_DD	0.02	UI	
eta_0	1.64E-08	V^2/GHz	
SNR_TX	32.5	dB	tdr selected
R_LM	0.95		
DER_0	1.00E-04		
Operational control			
COM Pass threshold	3	dB	
Include PCB	0	Value	0, 1, 2
g_DC_HP	[-6:1:0]		[min:step:max]
f_HP_PZ	0.6640625	GHz	

I/O control		
DIAGNOSTICS	0	logical
DISPLAY_WINDOW	0	logical
Display frequency domain	1	logical
CSV_REPORT	1	logical
RESULT_DIR	.\results\V165_{date}\	
SAVE_FIGURES	0	logical
Port Order	[1 3 2 4]	
RUNTAG	v165_d1p0a	
Receiver testing		
RX_CALIBRATION	0	logical
Sigma BBN step	5.00E-03	V
IDEAL_TX_TERM	0	logical
T_r	1.20E-02	ns
FORCE_TR	1	logical
Non standard control options		
COM_CONTRIBUTION	0	logical
New 'cd exploratory		
TDR	1	logical
WC_PORTZ	0	logical
T_k	0.6	ns

Table 93A-3 parameters		
Parameter	Setting	Units
package_tl_gamma0_a1_a2	[0 1.734e-3 1.455e-4]	
package_tl_tau	6.141E-03	ns/mm
package_Z_c	[83.7 102.3]	Ohm (tdr sel)
Table 92-12 parameters		
Parameter	Setting	Units
board_tl_gamma0_a1_a2	[0 4.114e-4 2.547e-4]	
board_tl_tau	6.191E-03	ns/mm
board_Z_c	110	Ohm
z_bp (TX)	151	mm
z_bp (NEXT)	72	mm
z_bp (FEXT)	72	mm
z_bp (RX)	151	mm

■ Cisco Channels (CH1, CH4, CH8)

- http://www.ieee802.org/3/cd/public/channel/Cisco_Backplane_channel_data.zip
- CH1 (10.8dB), CH4 (20.9dB), CH8 (30.1dB)
- 5 FEXT + 3 NEXT

■ TE Channels (CH41, CH42, CH43)

- http://www.ieee802.org/3/cd/public/channel/TEC_STRADAWhisper*.zip
- CH41 (10.5dB), CH42 (21.8dB), CH43 (32.0dB)
- 4 FEXT (F11F12,F17F18,H11H12,H17H18)
- 4 NEXT (F14F15,G11G12,G17G18,H14H15)

■ Intel 100Ω Channels (CH11-13, CH17-19, CH23-25) Intel 85Ω Channels (CH26-28, CH32-34, CH38-40)

- http://www.ieee802.org/3/50G/public/channel/mellitz_01_021716_??dB_6_channels.zip
- CH11-13/26-28(10dB), CH17-19/32-34(20dB), CH23-25/38-40(30dB)
- CH11/17/23/26/32/38 (Nom), CH12/18/24/27/33/39 (HzLzHz), CH13/19/25/28/34/40 (LzHzLz)
- 3 FEXT + 4 NEXT

■ Cavium Channels (CH44-47)

- http://www.ieee802.org/3/cd/public/channel/Cavium_??dB_H*.zip
- CH44-45 (20dB), CH46-47 (30dB)
- CH44/46 (HighZ), CH45/47 (HighZ_Nom_HighZ)
- 3 FEX + 4 NEXT

Thank you