

# Agenda and General Information

IEEE P802.3cs Task Force:  
Increased-reach Ethernet optical subscriber access  
(Super-PON)

Claudio DeSanti  
Dell Technologies  
Teleconference, May 19, 2022

# Agenda

---

- Welcome and Introductions
- Approve Agenda
- Approve past meeting minutes
- Goals for this meeting
- Big Ticket Items
- Reflector and Web
- Ground Rules
- IEEE
  - Structure, Bylaws and Rules
  - Call for Patents
  - IEEE Standards Process
- Liaisons and Communications
- Review of Action Items
- Presentations
- Comment resolution
- Motions and Closing Business
- Future Meetings

# Task Force Decorum

---



- An officer is permitted to make an audio or slideshow recording of this meeting exclusively for the purpose of generating minutes which shall not be copied or distributed. **IEEE 802.3 meetings do not use this option.** Recording of the proceedings by any other participant or observer, in part or in whole, via any means, is prohibited. (January 2019 IEEE-SA Standards Board Ops Manual 5.3.3.2)
- Press (i.e., anyone reporting publicly on this meeting) are to announce their presence (January 2019 IEEE-SA Standards Board Ops Manual 5.3.3.3)
- Please observe proper decorum in meetings

# Motion #1

---

- Move to approve the agenda
- M: Marek Hajduczenia – S: Vince Ferretti
  - > 50%
  - Motion carries by voice without opposition

# Goals for the meeting

---

- Resolve SA recirculation ballot comments

# Big ticket items

---

- Resolve SA recirculation ballot comments

# Reflector and Web

---

- To subscribe to the P802.3cs reflector, send an email to:

[ListServ@ieee.org](mailto:ListServ@ieee.org)

with the following in the body of the message (do not include “<>”):

*subscribe* STDS-802-3-SUPER-PON <yourfirstname> <yourlastname>  
*end*

- Send P802.3cs reflector messages to:

[STDS-802-3-SUPER-PON@listserv.ieee.org](mailto:STDS-802-3-SUPER-PON@listserv.ieee.org)

- Task Force web page URL:

<http://www.ieee802.org/3/cs/index.html>

# Task Force Private Area

---

- URL: <http://www.ieee802.org/3/cs/private/index.html>
  - Username: 802.3cs
  - Password: <<XXXXXXX>>
- Write it down...
- Note - The draft, and any other content, is posted for your review only, and neither the content nor access information should be copied or redistributed to others in violation of document copyrights.



# Ground Rules

---

- Based upon IEEE 802.3 Rules
  - Foundation based upon Robert's Rules of Order
  - Anyone in the room may speak
  - Anyone in the room may vote
- **RESPECT**... give it, get it
- NO product pitches
- NO corporate pitches
- NO prices!!!
  - This includes costs, ASPs, etc. no matter what the currency
- NO restrictive notices

# Attendance

---

- Tutorial Material on attendance tool
  - [http://ieee802.org/3/minutes/attendance\\_procedures.pdf](http://ieee802.org/3/minutes/attendance_procedures.pdf)
- Access details
  - URL: <http://imat.ieee.org/>
  - (For interim) Password will be provided

# IEEE Structure

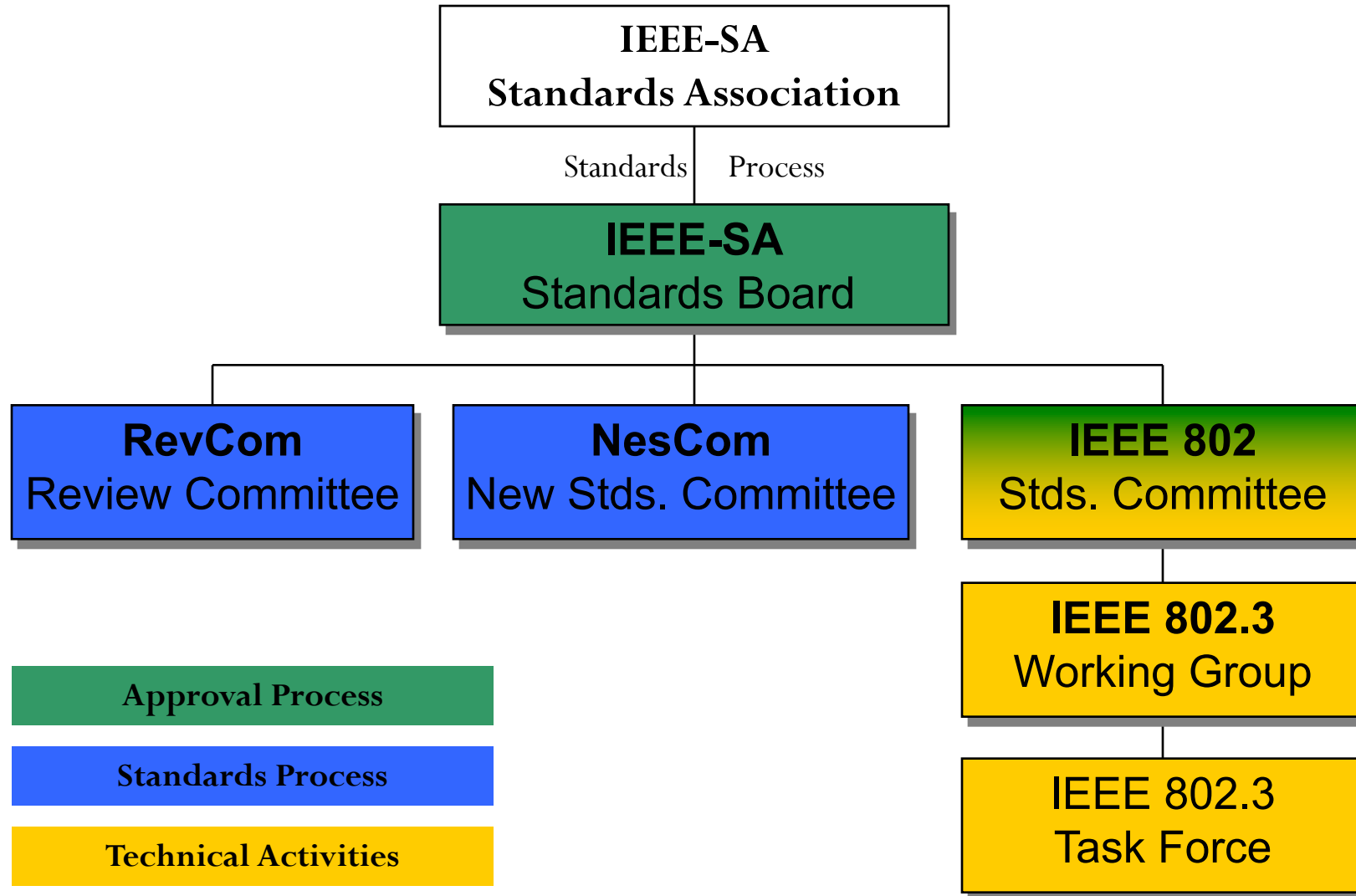

# Important Bylaws and Rules

---

- **IEEE-SA Operations Manual**  
[http://standards.ieee.org/develop/policies/sa\\_opman/](http://standards.ieee.org/develop/policies/sa_opman/)
- **IEEE-SA Standards Board Bylaws**  
<http://standards.ieee.org/develop/policies/bylaws/>
- **IEEE-SA Standards Board Operations Manual**  
<http://standards.ieee.org/develop/policies/opman/>
- **IEEE 802 LAN/MAN Standards Committee (LMSC) Policies and Procedures**  
<https://ieee.app.box.com/v/PandP-LMSC>
- **IEEE 802 LAN/MAN Standards Committee (LMSC) Operations Manual**  
<http://www.ieee802.org/devdocs.shtml>
- **IEEE 802 LAN/MAN Standards Committee (LMSC) Working Group (WG) Policies and Procedures**  
<http://www.ieee802.org/devdocs.shtml>
- **IEEE 802.3 Working Group Operating Rules**  
[http://ieee802.org/3/rules/P802\\_3\\_rules.pdf](http://ieee802.org/3/rules/P802_3_rules.pdf)

# **PARTICIPANTS HAVE A DUTY TO INFORM THE IEEE**

- Participants shall inform the IEEE (or cause the IEEE to be informed) of the identity of each holder of any potential Essential Patent Claims of which they are personally aware if the claims are owned or controlled by the participant or the entity the participant is from, employed by, or otherwise represents
- Participants should inform the IEEE (or cause the IEEE to be informed) of the identity of any other holders of potential Essential Patent Claims

**Early identification of holders of potential  
Essential Patent Claims is encouraged**

# **WAYS TO INFORM IEEE**

- **Cause an LOA to be submitted to the IEEE SA ([patcom@ieee.org](mailto:patcom@ieee.org)); or**
- **Provide the chair of this group with the identity of the holder(s) of any and all such claims as soon as possible; or**
- **Speak up now and respond to this Call for Potentially Essential Patents**

If anyone in this meeting is personally aware of the holder of any patent claims that are potentially essential to implementation of the proposed standard(s) under consideration by this group and that are not already the subject of an Accepted Letter of Assurance, please respond at this time by providing relevant information to the WG Chair

# OTHER GUIDELINES FOR IEEE WORKING GROUP MEETINGS

- All IEEE SA standards meetings shall be conducted in compliance with all applicable laws, including antitrust and competition laws.
  - Don't discuss the interpretation, validity, or essentiality of patents/patent claims.
  - Don't discuss specific license rates, terms, or conditions.
    - Relative costs of different technical approaches that include relative costs of patent licensing terms may be discussed in standards development meetings.
      - Technical considerations remain the primary focus.
  - Don't discuss or engage in the fixing of product prices, allocation of customers, or division of sales markets.
  - Don't discuss the status or substance of ongoing or threatened litigation.
  - Don't be silent if inappropriate topics are discussed. Formally object to the discussion immediately.

-----  
For more details, see *IEEE SA Standards Board Operations Manual*, clause 5.3.10 and *Antitrust and Competition Policy: What You Need to Know* at <http://standards.ieee.org/develop/policies/antitrust.pdf>

# PATENT-RELATED INFORMATION

The patent policy and the procedures used to execute that policy are documented in the:

- ***IEEE SA Standards Board Bylaws***  
(<http://standards.ieee.org/develop/policies/bylaws/sect6-7.html#6>)
- ***IEEE SA Standards Board Operations Manual***  
(<http://standards.ieee.org/develop/policies/opman/sect6.html#6.3>)

Material about the patent policy is available at  
<http://standards.ieee.org/about/sasb/patcom/materials.html>

**If you have questions, contact the IEEE SA  
Standards Board Patent Committee  
Administrator at [patcom@ieee.org](mailto:patcom@ieee.org)**



---

# Participant behavior in IEEE-SA activities is guided by the IEEE Codes of Ethics & Conduct

- All participants in IEEE-SA activities are expected to adhere to the core principles underlying the:
  - [IEEE Code of Ethics](#)
  - [IEEE Code of Conduct](#)
- The core principles of the IEEE Codes of Ethics & Conduct are to:
  - *Uphold the highest standards of integrity, responsible behavior, and ethical and professional conduct*
  - *Treat people fairly and with respect, to not engage in harassment, discrimination, or retaliation, and to protect people's privacy.*
  - *Avoid injuring others, their property, reputation, or employment by false or malicious action*
- The most recent versions of these Codes are available at <http://www.ieee.org/about/corporate/governance>

---

## Participants in the IEEE-SA “*individual process*” shall act independently of others, including employers

- The [IEEE-SA Standards Board Bylaws](#) require that “*participants in the IEEE standards development individual process shall act based on their qualifications and experience*”
- This means participants:
  - **Shall act & vote** based on their personal & independent opinions derived from their expertise, knowledge, and qualifications
  - **Shall not act or vote** based on any obligation to or any direction from any other person or organization, including an employer or client, regardless of any external commitments, agreements, contracts, or orders
  - **Shall not direct** the actions or votes of other participants or retaliate against other participants for fulfilling their responsibility to act & vote based on their personal & independently developed opinions
- By participating in standards activities using the “*individual process*”, you are deemed to accept these requirements; if you are unable to satisfy these requirements then you shall immediately cease any participation

---

## IEEE-SA standards activities shall allow the fair & equitable consideration of all viewpoints

- The [IEEE-SA Standards Board Bylaws](#) (clause 5.2.1.3) specifies that *“the standards development process shall not be dominated by any single interest category, individual, or organization”*
  - This means no participant may exercise *“authority, leadership, or influence by reason of superior leverage, strength, or representation to the exclusion of fair and equitable consideration of other viewpoints”* or *“to hinder the progress of the standards development activity”*
- This rule applies equally to those participating in a standards development project and to that project’s leadership group
- Any person who reasonably suspects that dominance is occurring in a standards development project is encouraged to bring the issue to the attention of the Standards Committee or the project’s IEEE-SA Program Manager

# Overview of IEEE 802.3 Standards Process (1/5)- Study Group Phase

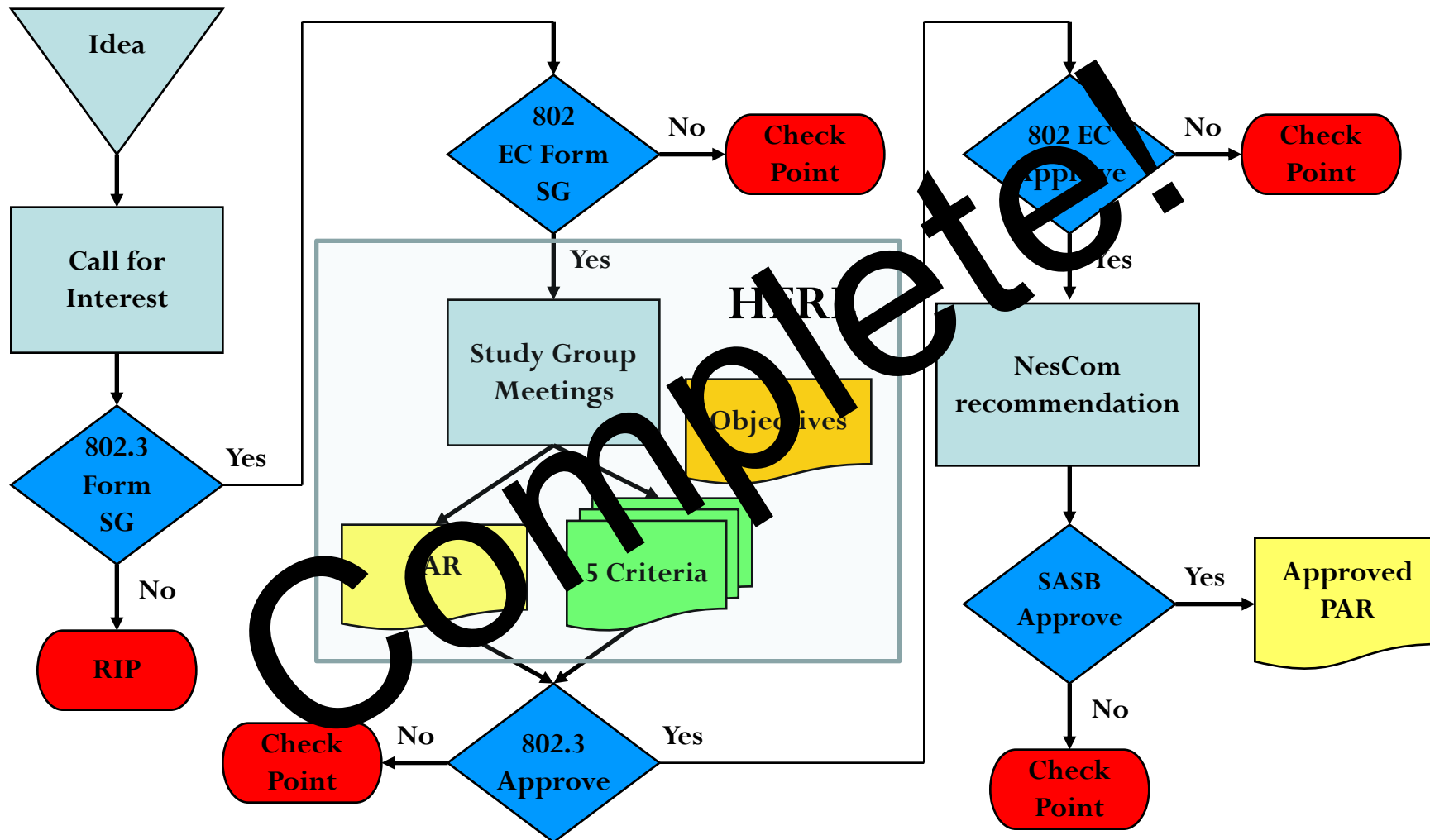

Note: At "Check Point", either the activity is ended, or there may be various options that would allow reconsideration of the approval.

# Overview of IEEE 802.3 Standards Process (2/5) – Task Force Comment Phase

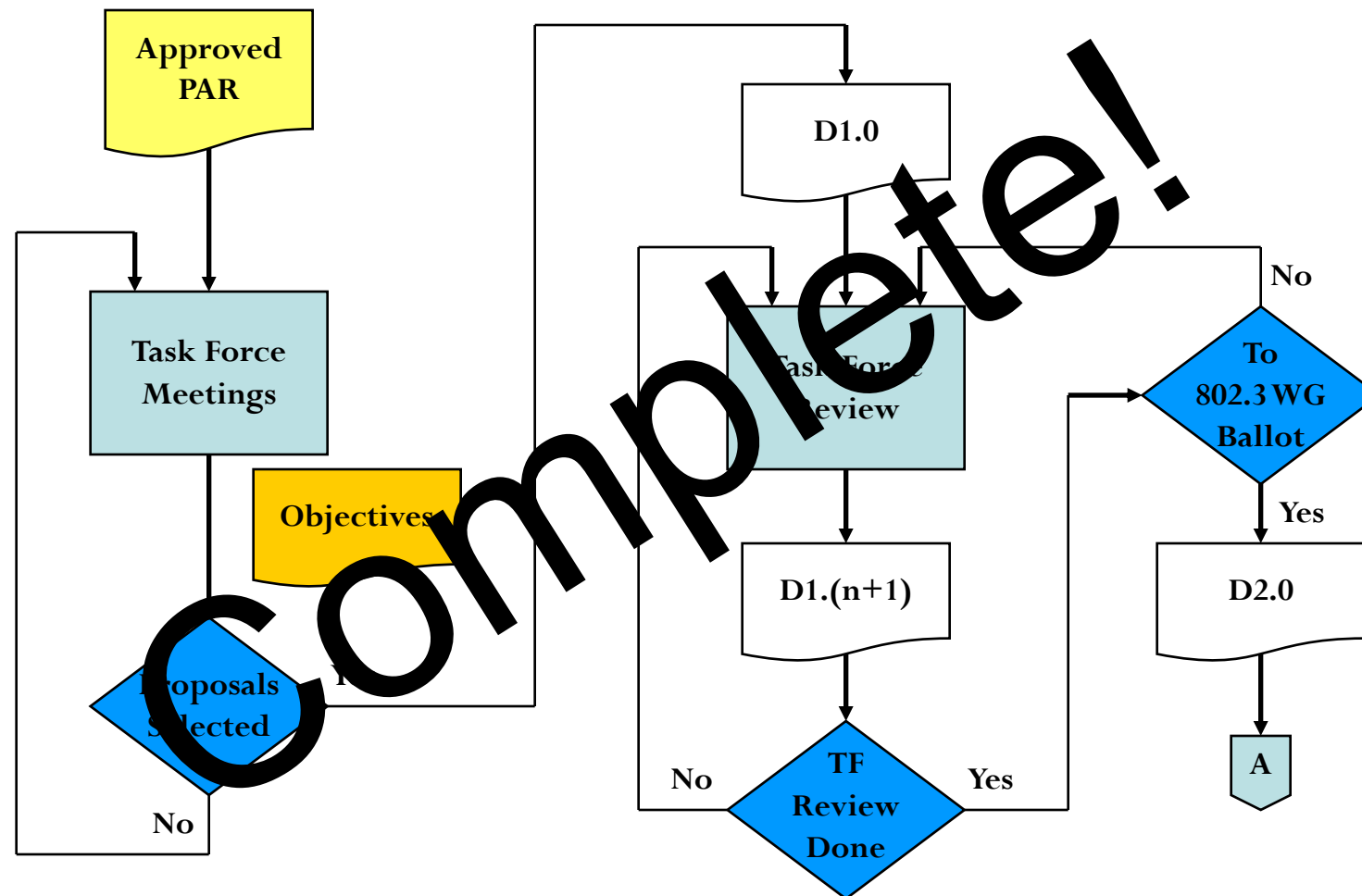

# Overview of IEEE 802.3 Standards Process (3/5) – Working Group Ballot Phase

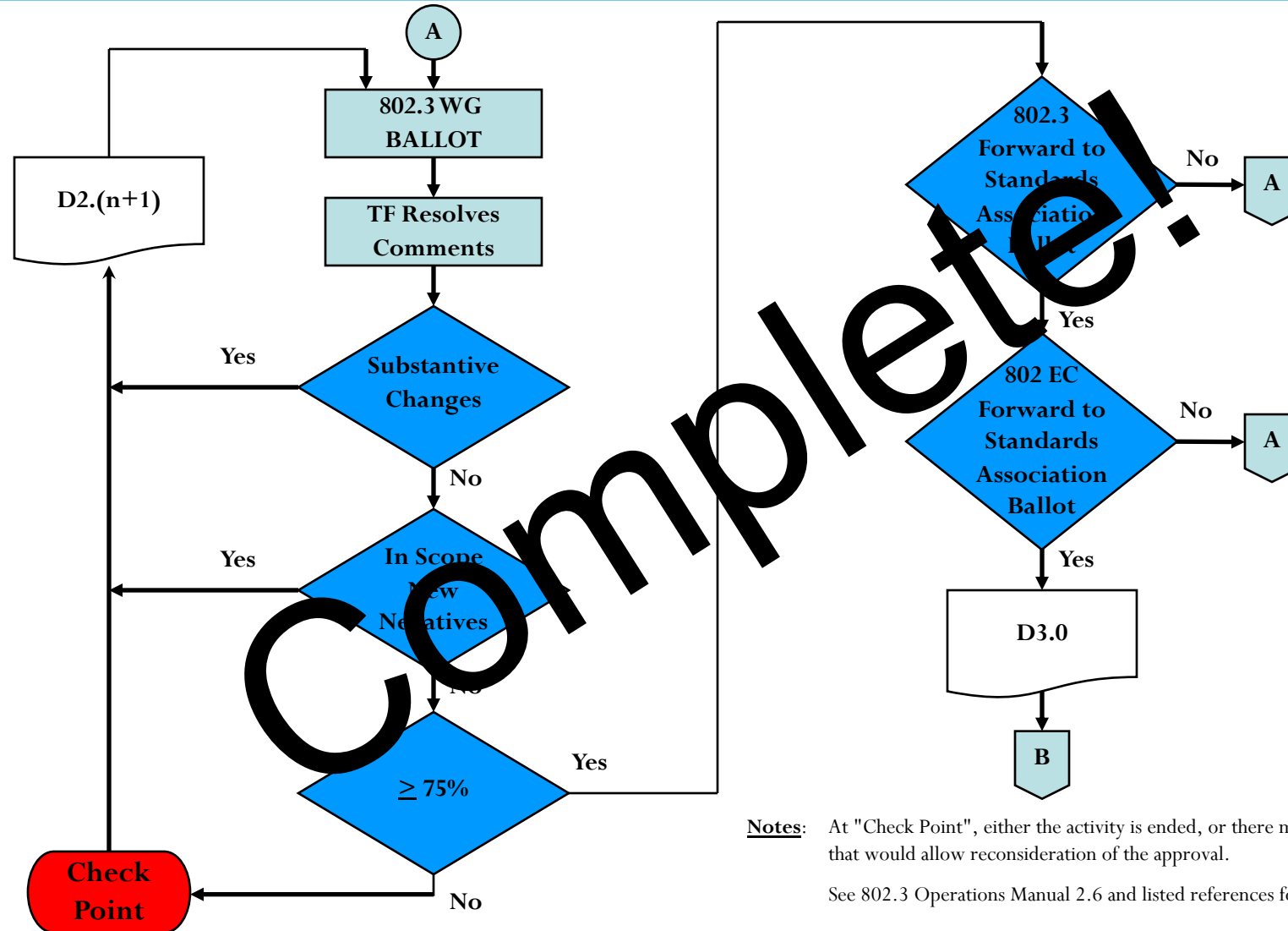

**Notes:** At "Check Point", either the activity is ended, or there may be various options that would allow reconsideration of the approval.  
See 802.3 Operations Manual 2.6 and listed references for complete description

# Overview of IEEE 802.3 Standards Process (4/5)- IEEE Standards Association (SA) Ballot Phase

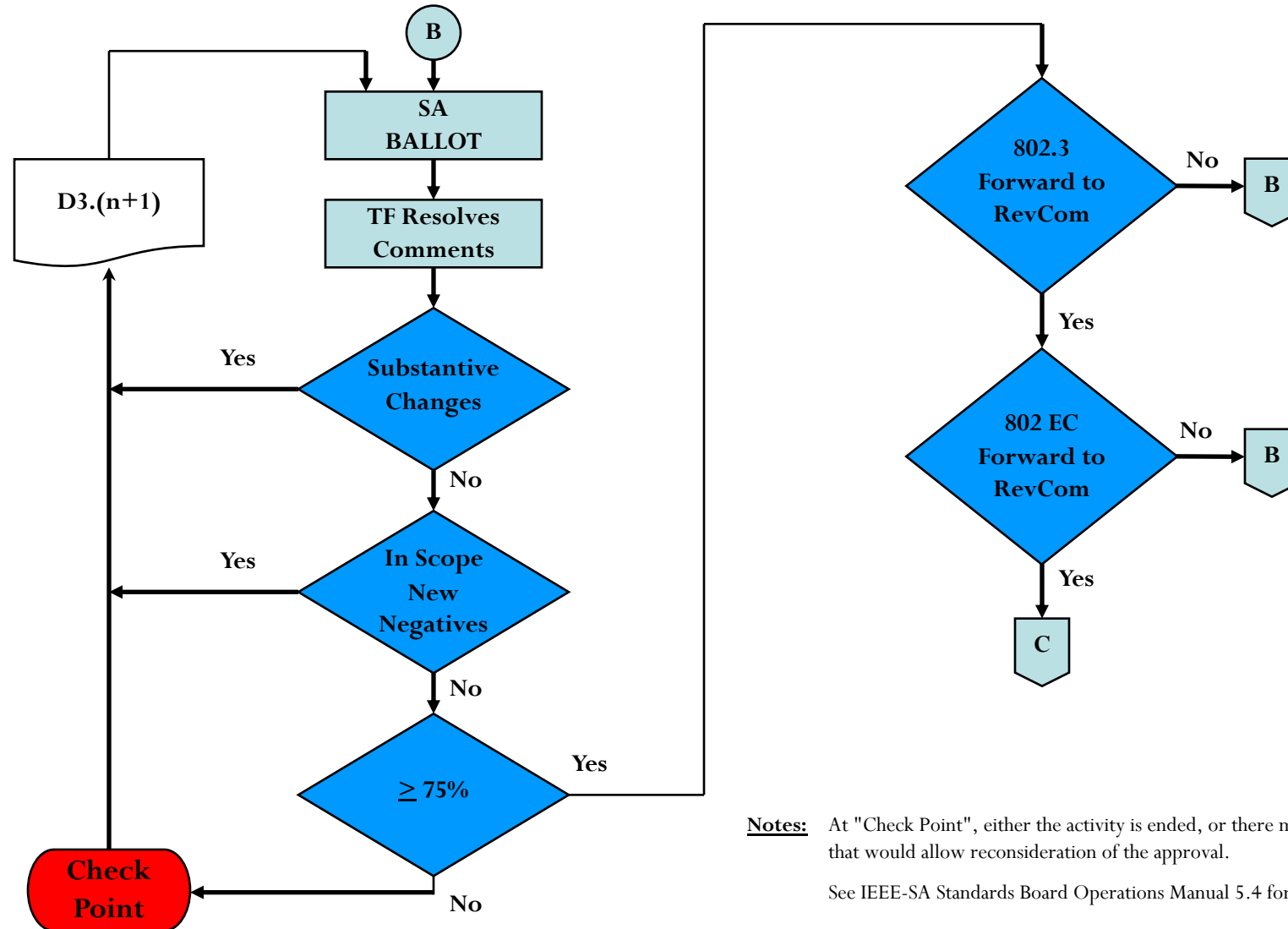

**Notes:** At "Check Point", either the activity is ended, or there may be various options that would allow reconsideration of the approval.  
See IEEE-SA Standards Board Operations Manual 5.4 for complete description

# Overview of IEEE 802.3 Standards Process (5/5) – Final Approvals / Standard Release

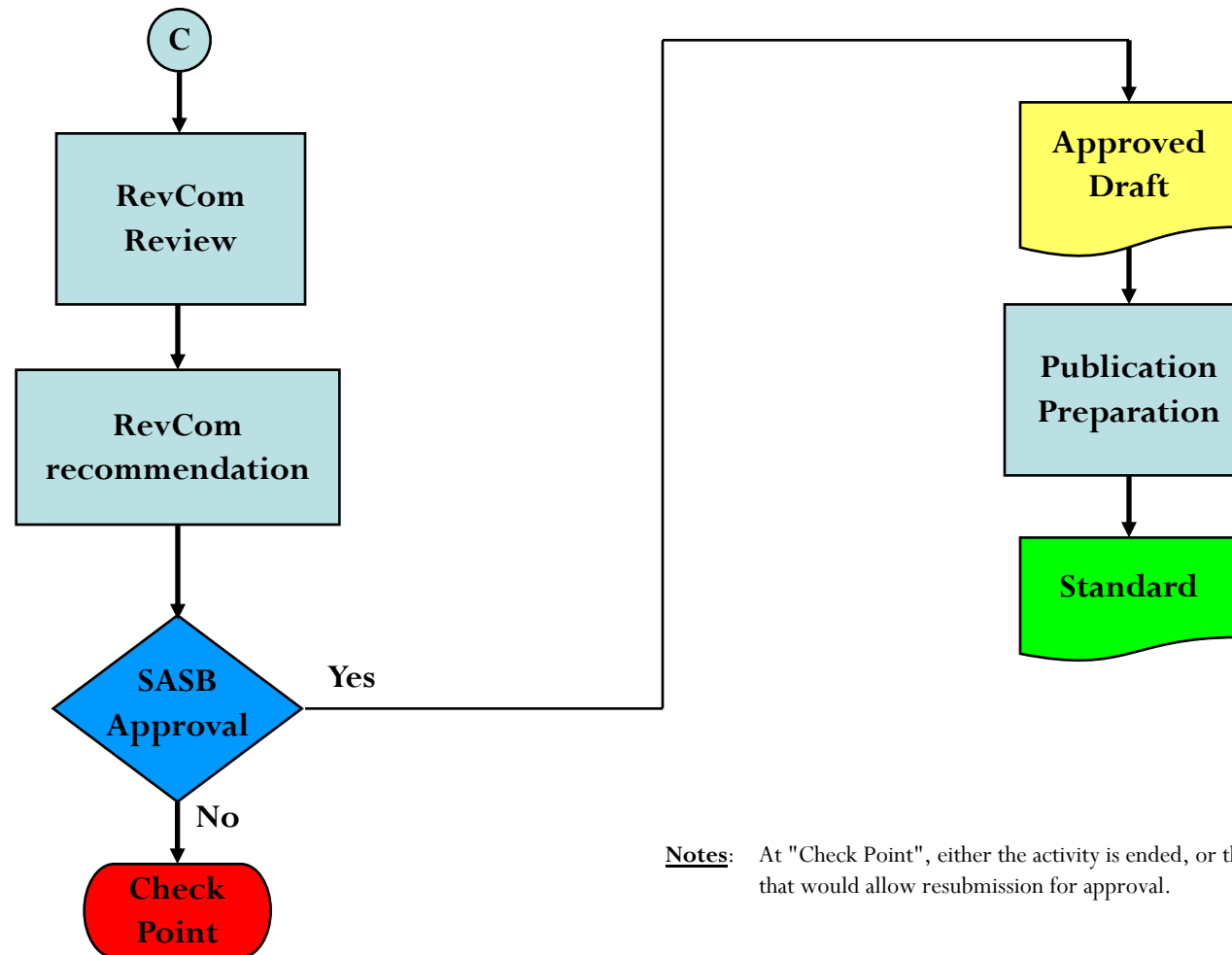

**Notes:** At "Check Point", either the activity is ended, or there may be various options that would allow resubmission for approval.



# Action Items

---

- None

# IEEE P802.3cs Super-PON Approved Project Documents

---

- PAR
  - [http://www.ieee802.org/3/cs/P802\\_3cs\\_PAR.pdf](http://www.ieee802.org/3/cs/P802_3cs_PAR.pdf)
- 5 Criteria
  - <https://mentor.ieee.org/802-ec/dcn/18/ec-18-0246-00-ACSD-p802-3cs.pdf>
- Objectives
  - [http://www.ieee802.org/3/cs/Super-PON\\_Objectives.pdf](http://www.ieee802.org/3/cs/Super-PON_Objectives.pdf)

# IEEE P802.3cs Super-PON Objectives

---

- Provide Physical Layer specifications that:
  - Preserve the Ethernet frame format utilizing the Ethernet MAC
  - Support a BER of better than or equal to  $10^{-12}$  at the MAC/PLS service interface (or the frame loss ratio equivalent)
  - Support a passive point-to-multipoint ODN with a reach of at least 50 km with at least 1:64 split ratio per wavelength pair
  - Support at least 16 wavelength pairs for point-to-multipoint PON operation
  - Support the MAC data rate of 10Gb/s downstream
  - Support the MAC data rates of 2.5Gb/s and 10Gb/s upstream
  - Leverage existing EPON PCS and PMA to support the above MAC data rates
  - Support tunable transmitters

# IEEE P802.3cs Super-PON Adopted Timeline

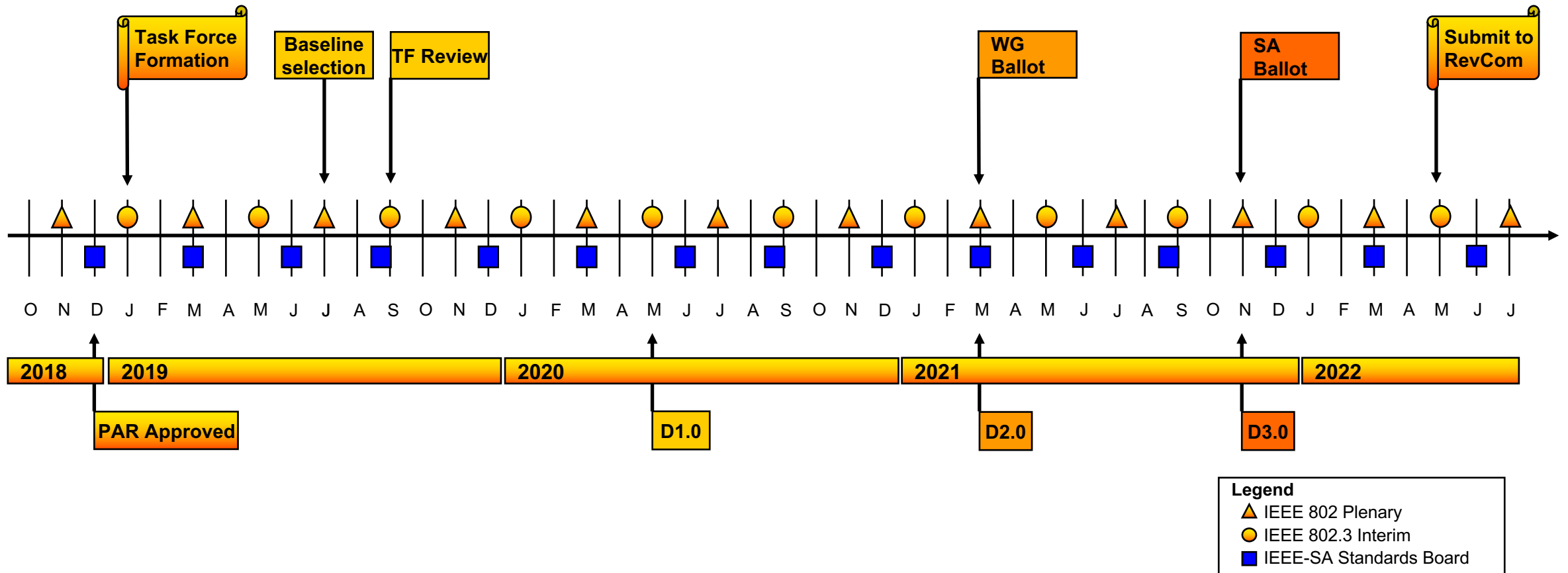

# IEEE P802.3cs Super-PON Updated Timeline

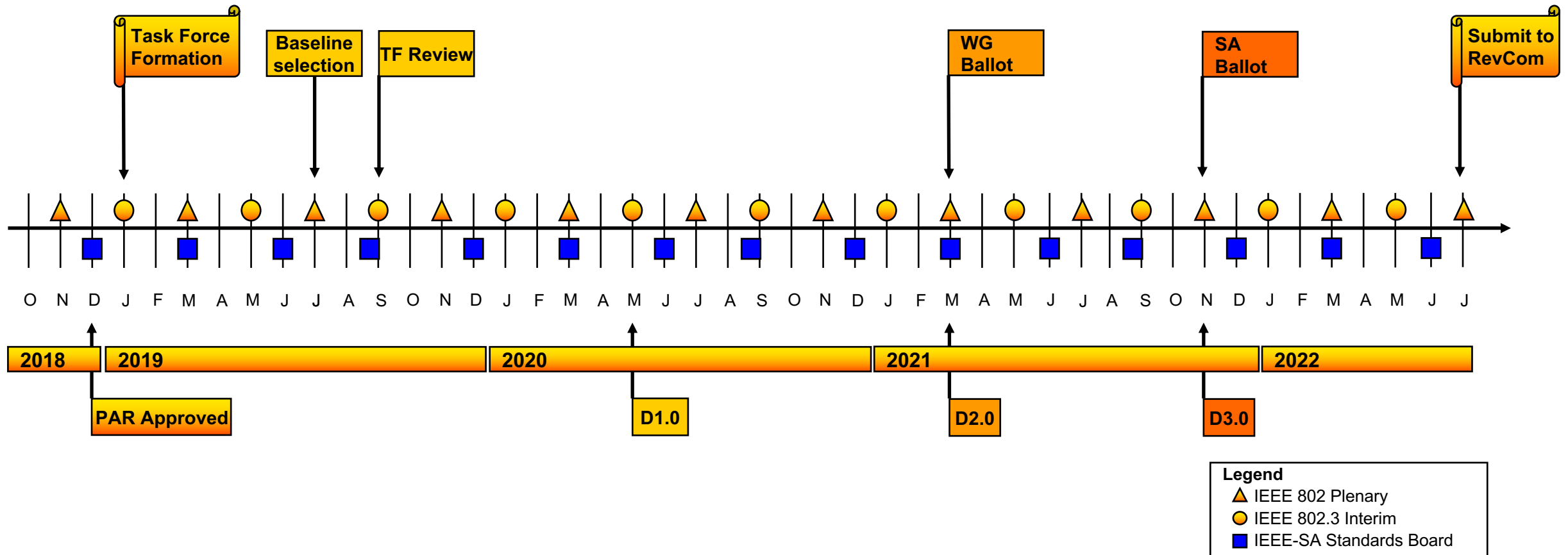

# IEEE P802.3cs Super-PON Standards Association ballot results

- Item 1 - Date the ballot closed:
  - The third SA recirculation ballot on IEEE P802.3cs draft D3.3 closed on 05/10/2022 at 11:59 PM EST
- Item 2 - Vote tally:

Comments: 15

	Draft D3.3			Req %
	#	%	Status	
Abstain	2	2	PASS	< 30
Disapprove with comment	0	-	-	-
Disapprove without comment	0	-	-	-
Approve	82	100	PASS	≥ 75
Ballots returned	84	91	PASS	≥ 75
Voters	92	-	-	-

# Presentations

---

- Comments Resolution
  - Marek Hajduczenia (Charter)

# Motion #2

---

- Move to accept the proposed responses to D3.3 comments in the bucket list
- M: Marek Hajduczenia – S: Bob Grow
  - $\geq 75\%$
  - Motion carries by voice without opposition



# Liaisons and Communications

---

- none

# Motion #3

---

- Move to instruct the editor to generate P802.3cs draft 3.4, using draft 3.3 as baseline and incorporating all accepted material
- M: Marek Hajduczenia – S: Vince Ferretti
  - $\geq 75\%$
  - Motion carries by voice without opposition

# Next Meeting

---

- July 2022 Plenary

# Motion #4

---

- Move to adjourn
- M: Liang Du – S: Sunny Xu
  - > 50%
  - Motion carries by voice without opposition

---

# Thank You!