

IEEE 802.3CY – BEYOND 10G ELECTRICAL AUTOMOTIVE ETHERNET PHY TF

Link Segment Insertion Loss Measurements Updated with 7 meters

Eric DiBiaso, Bert Bergner, Emilio Cuesta

October 28, 2020

Purpose of the Analysis

- Measure insertion loss of available automotive cables with attached connectors up to 10 GHz
- Consider various operating temperatures and environmental conditions
- Focus on 11m & 7m link segments without inline connectors

Fixture description and de-embedding

- PCB Trace length: 20mm
- PCB Stackup:

W = 1.145mm	Cu 35 μm
H = 780mm	Rogers 780 μm
	Cu 35 μm
- PCB total loss (x2 to consider loss at both sides)

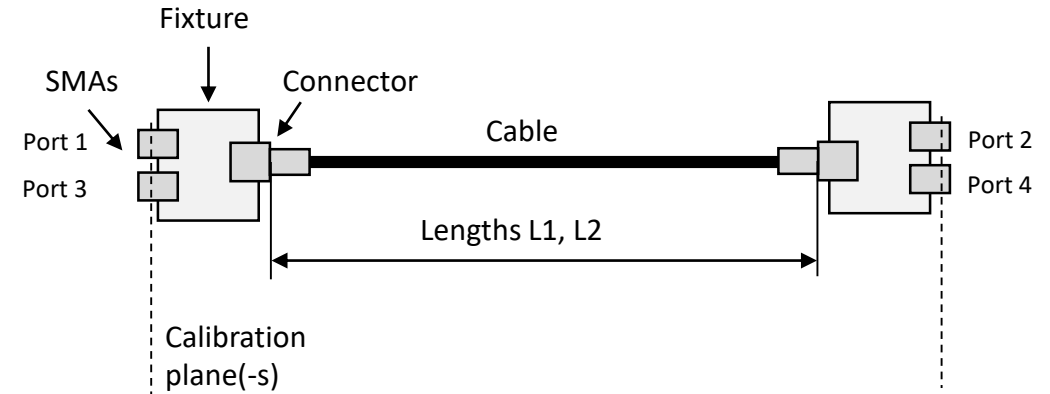

- simple de-embedding by measuring 2 cable lengths incl. fixtures and subtraction of LogMag ILs:

$$IL_{2x\text{ Fixture}} = IL_{\text{Cable } 1+2x\text{Fix}} - \frac{L1}{L2 - L1} (IL_{\text{Cable } 2+2x\text{Fix}} - IL_{\text{Cable } 1+2x\text{Fix}})$$

- smoothing to eliminate ripples

→ sufficient accuracy to consider the fixtures IL

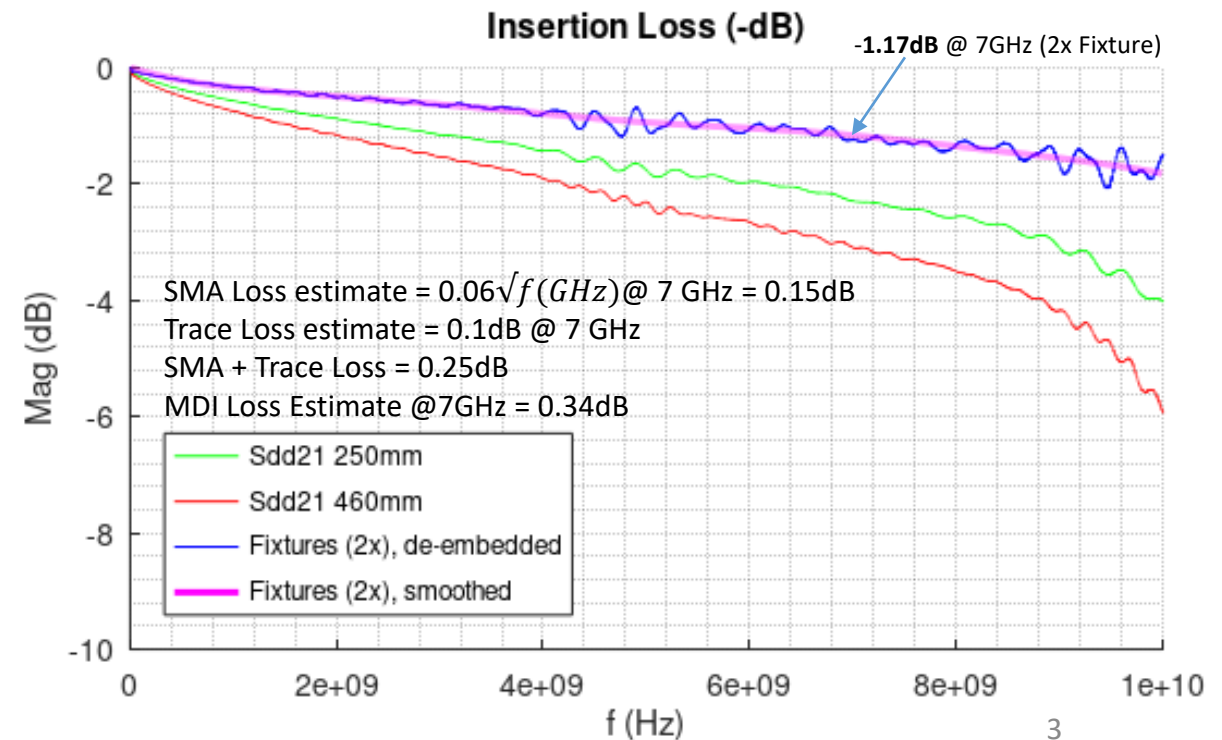

Test Sequence and Samples

- S-parameter were captured at different temperatures in the following sequence (same cable assemblies):
 - T0 = 23°C
 - T1 = -40°C
 - T2 = 23°C
 - T3 = 105°C
 - T4 = 23°C
 - T5 = 23°C, measurements done after 10 days storage at 95% relative humidity and 40°C
(90 min relaxation at room temperature after taking samples out of climate chamber to allow temperature adaptation)
 - T6 = 23°C, measurements done after another 7 days storage at < 45% relative humidity and 23°C
- Samples:
 - (available automotive cables / cable prototypes)
 - Cable A**
 - construction A
 - 5 GHz type
 - 2x 0.14mm² (AWG 26) stranded
 - Cable B**
 - construction B
 - 6 GHz type
 - 2x 0.14mm² (AWG 26) stranded



Insertion Losses (fixtures *not* removed)

Insertion Loss (-dB)

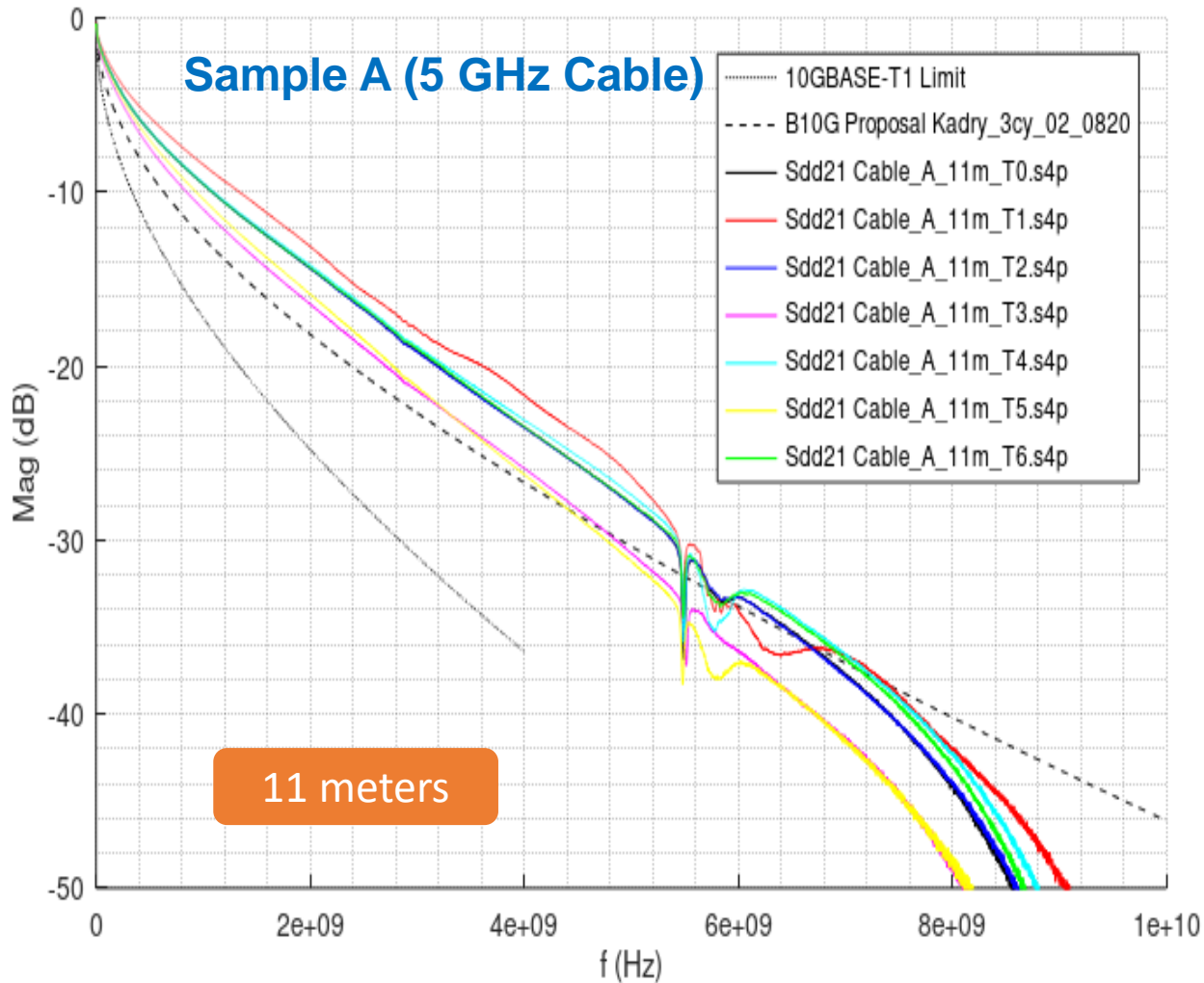

Insertion Loss (-dB)

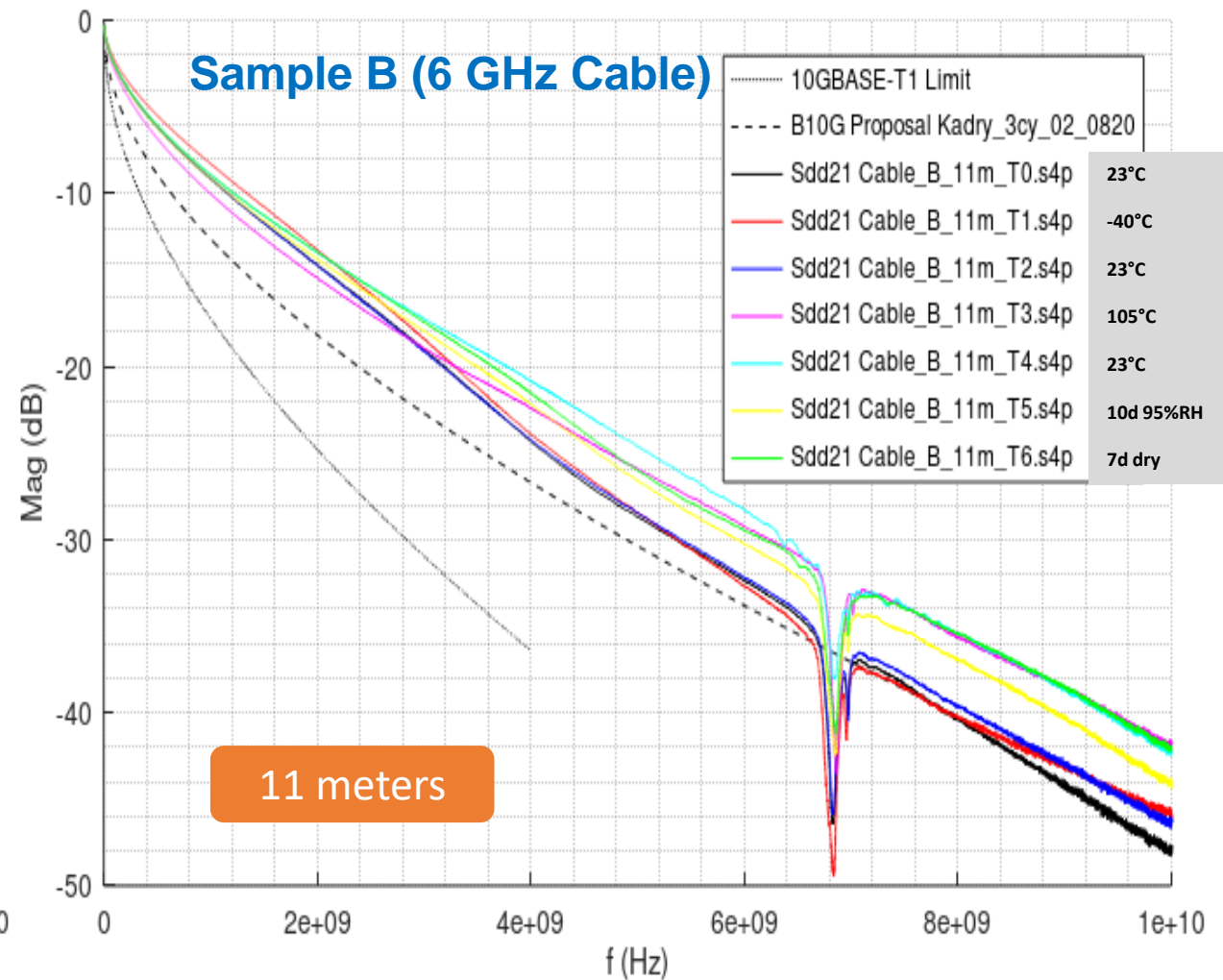

Scaled by 7/11

Insertion Losses (fixtures not removed)

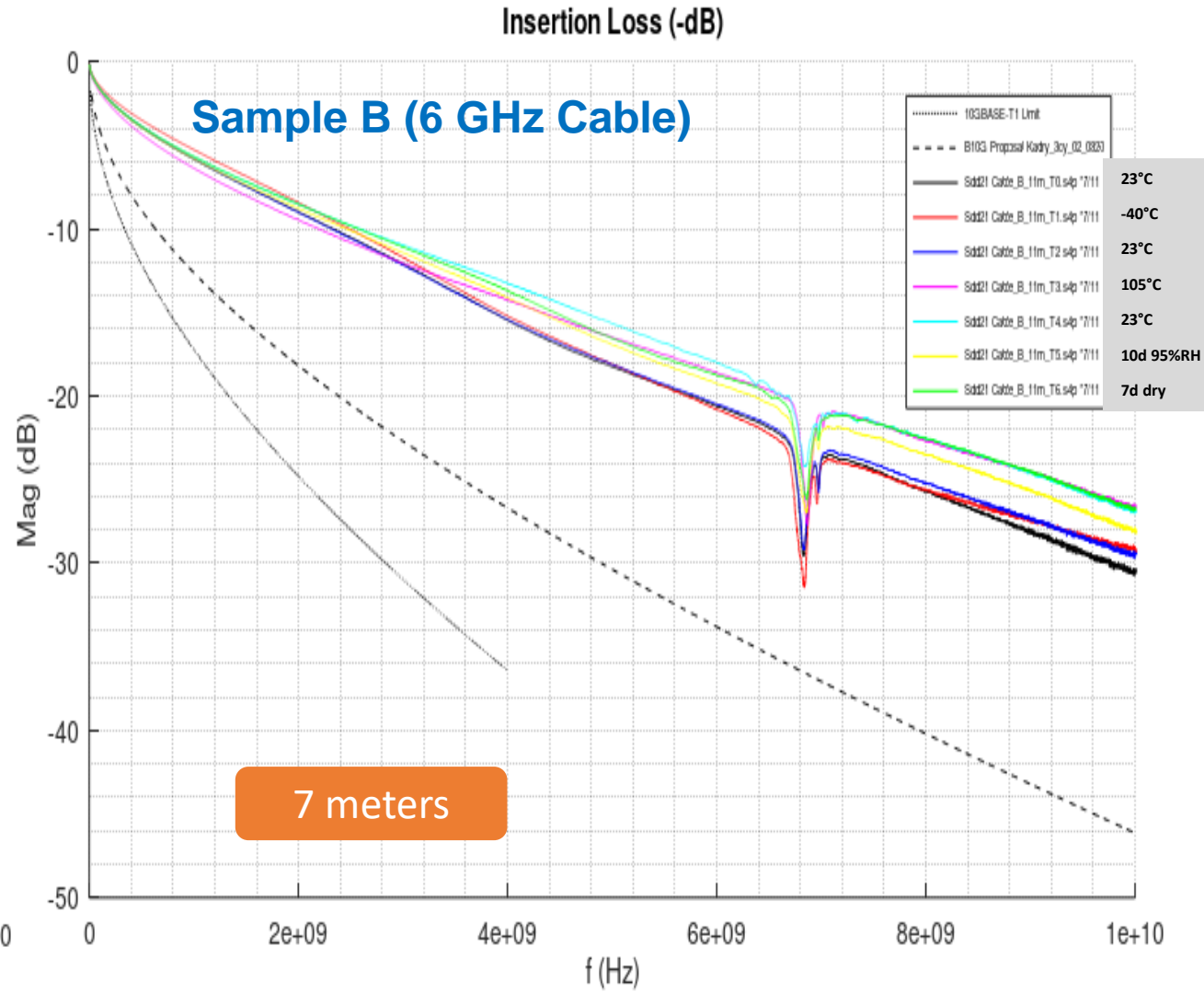
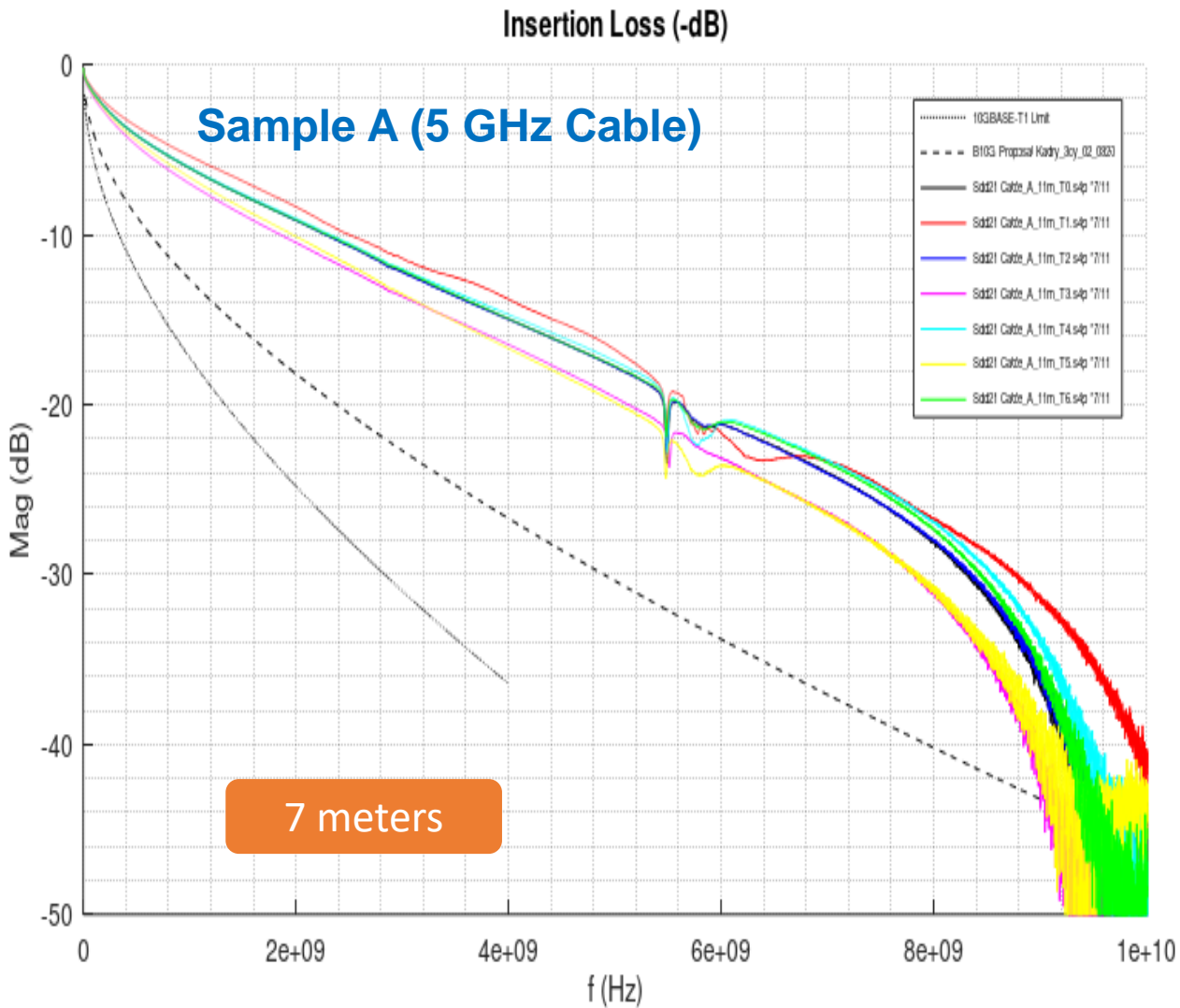

Insertion Losses – Sample B (fixtures removed)

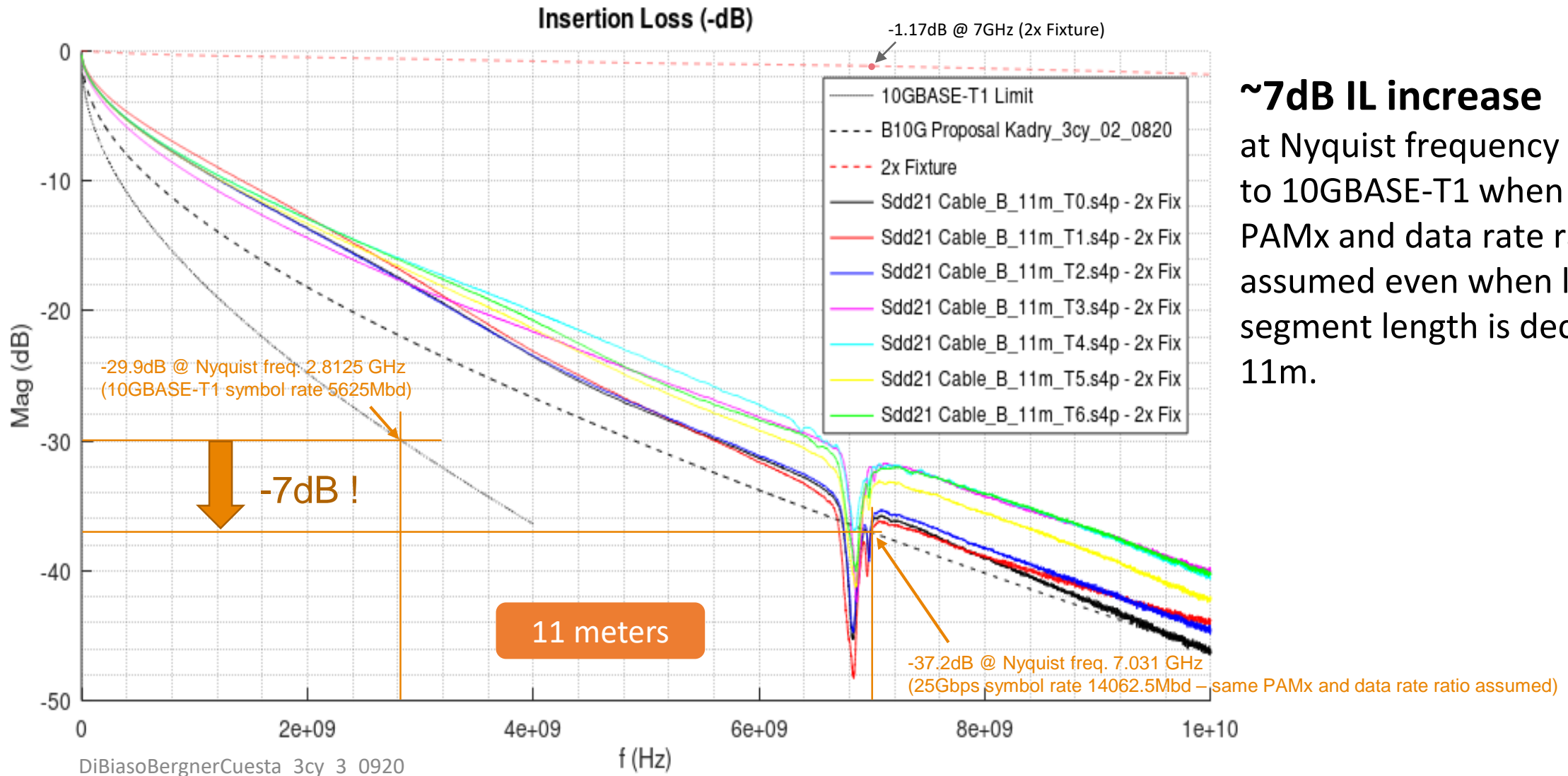

~7dB IL increase

at Nyquist frequency compared to 10GBASE-T1 when same PAMx and data rate ratio is assumed even when link segment length is decreased to 11m.

Scaled by 7/11

Insertion Losses – Sample B (fixtures removed)

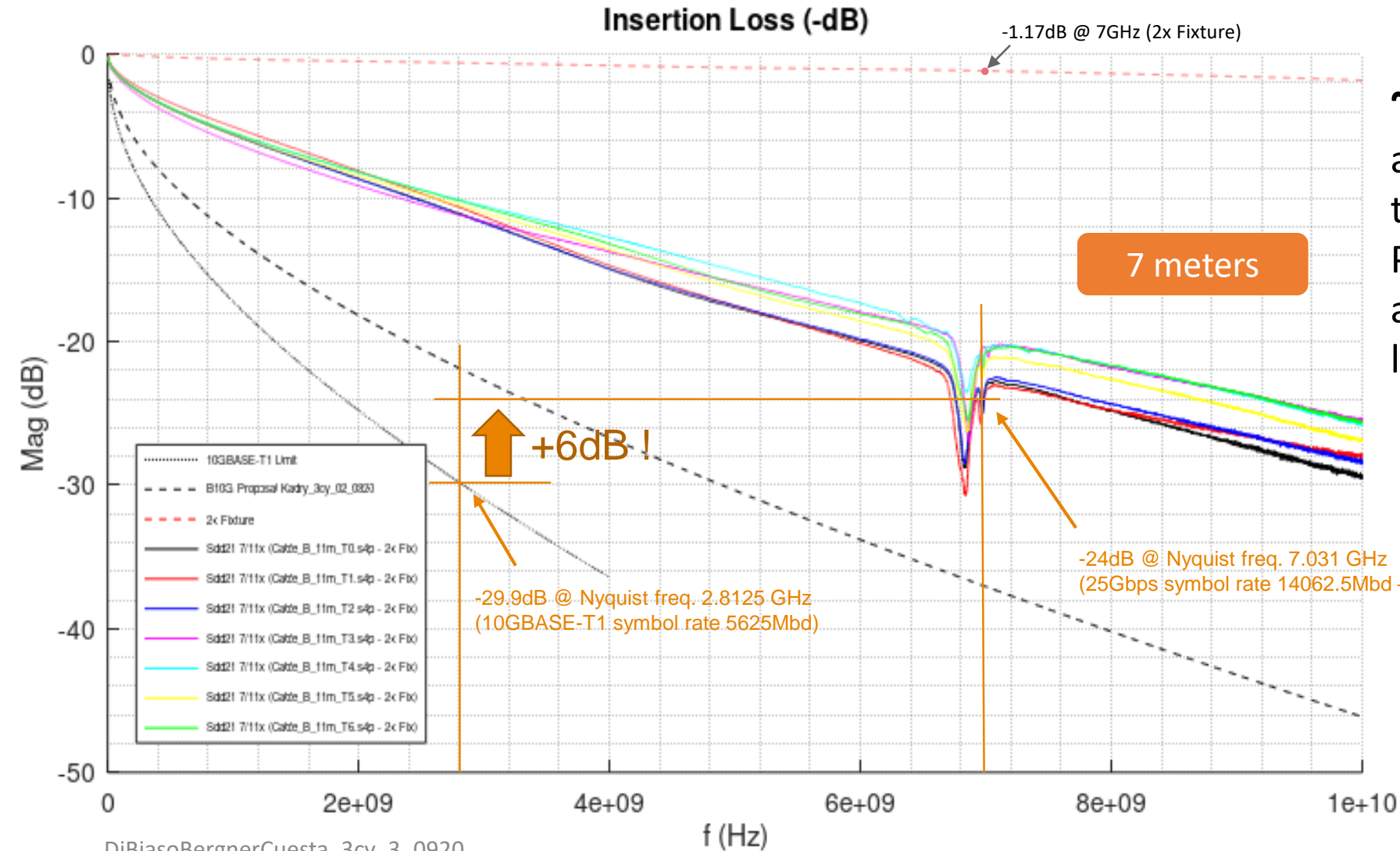

~6dB IL decrease

at Nyquist frequency compared to 10GBASE-T1 when same PAMx and data rate ratio is assumed when link segment length is decreased to 7m.

Conclusions / T.b.d.'s

- IL proposal in [Kadry_3cy_02_0820.pdf](#) can be met with Sample B, but only up to its maximum specified frequency of 6GHz
- Using existing AWG26 cables for 11m results in 7 dB additional IL compared to the 10GBASE-T1 link segment budget at corresponding Nyquist frequency for same data modulation ratio
- Using existing AWG26 cables for 7m results in 6 dB less IL compared to the 10GBASE-T1 link segment budget at corresponding Nyquist frequency for same data modulation ratio
- Potential for achieving higher frequencies with changed cable constructions (moving “notch” toward higher frequencies)
 - Discuss which max. frequency is needed (Kadry_3cy_02_0820.pdf proposes 7 GHz)
 - Discuss PAMx modulation level to reduce Nyquist frequency
- Reduction of IL requirement by defining 2 link segment options (Ex. 0-7m / 7-11m)
- What additional IL margin may be needed?
 - Additional permanent long term degradation
→ see https://standards.ieee.org/content/dam/ieee-standards/standards/web/documents/presentations/d2-07_ohni_influence_of_aging_effects_v2.0.pdf
 - IL dips due to corresponding RL peaks (connectors, cable bends, cable squeezing)

Thank You!!!