

Agenda and General Information

**IEEE P802.3df Task Force
Electrical Ad hoc**

18 April 2022

**Kent Lusted
Chair, Ad hoc
Intel Corporation**



IEEE P802.3df 18 April 2022 Ad Hoc Electronic Meeting

- **Please sign into IMAT to record of Meeting attendance**
- **Agenda**
 - **Approve Agenda**
 - **Ad Hoc Charter**
 - **Review IEEE SA Policies (<http://ieee802.org/3/policies.html> / included)**
 - **IEEE SA Patent Policy**
 - **IEEE SA Participation Policy**
 - **IEEE SA Copyright Policy**
 - **Presentations**
 - "802.3df 800GBASE-CR8 Annex 162C/162D Table Revisions", Chris Diminico
 - "200G/lane Electrical interfaces –System implications", Adeo Ran
 - **Future Meetings**

* Note – additional slides covering procedures and IEEE-SA Policies are in Backup

Meeting Decorum

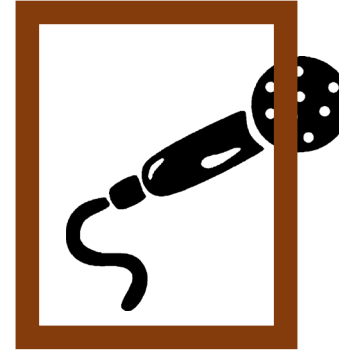
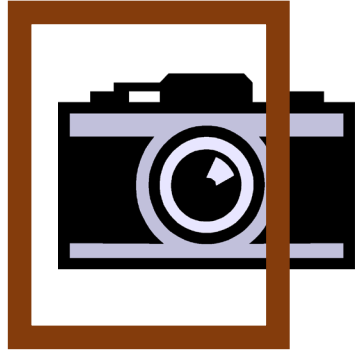

- **An officer is permitted to make an audio or slideshow recording of this meeting exclusively for the purpose of generating minutes which shall not be copied or distributed. IEEE 802.3 meetings do not use this option. Recording of the proceedings by any other participant or observer, in part or in whole, via any means, is prohibited. (Jan 2019 IEEE-SA Standards Board Ops Manual 5.3.3.2)**
- **Press (i.e., anyone reporting publicly on this meeting) are to announce their presence (Jan 2019 IEEE-SA Standards Board Ops Manual 5.3.3.3)**
- **Cell phone ringers off**
- **Please observe proper decorum in meetings**
- **Please mute your self when not speaking**
- **Please turn video off**

Review of IEEE SA Policies

- **Policies**
 - **Patent Policy**
 - **Copyright Policy**
 - **Participation**
- **See Backup for slides**

Ad Hocs

Announcement - <https://www.ieee802.org/3/B400G/email/msg00257.html>

1. Architecture and Logic Ad hoc – Mark Gustlin, Ad Hoc Chair

Charter: The Architecture and Logic Ad Hoc is chartered to address the following:

- 1) Develop terminology and definitions for terms related to architecture, including but not limited to FEC Architecture, FEC Scheme, End-to-end FEC, Segmented FEC, Concatenated FEC. Draft definitions to be presented to Task Force at May 2022 session.
- 2) Act as forum to discuss architectural requirements and consider proposals related to PCS, FEC, and PMA logic sublayers.

2. Electrical Ad Hoc – Kent Lusted, Ad Hoc Chair

Charter: The Electrical Ad Hoc is chartered to address the following:

- 1) Act as forum to discuss and consider technical proposals and contributions:
 - a. Related to electrical interfaces and electrical PMD sublayers
 - b. Related to logic PCS, FEC, and PMA sublayers that may impact electrical interfaces and electrical PMD sublayers
 - c. Electrical interfaces and electrical PMD nomenclature
- 2) Provide inputs based on electrical interfaces and electrical PMD sublayers into any relevant ad hocs

3. Optics Ad Hoc – Mark Nowell, Ad Hoc Chair

Charter: The Optical Ad Hoc is chartered to address the following:

- 1) Act as forum to discuss and consider technical proposals and contributions:
 - a. Related to optical PMD sublayers
 - b. Related to logic PCS, FEC, and PMA sublayers that may impact optical PMD sublayers
 - c. Optical PMD nomenclature
- 2) Provide inputs based on optical PMDs into any relevant ad hocs

Future Ad hoc Meetings

1. Architecture and Logic Ad hoc

- 25 Apr 2022, 10am to 12pm, ET, [Call Info](#)
- 11 Apr 2022, 10am to 12pm, ET, [Call Info](#)

2. Electrical Ad Hoc

- 02 May 2022, 10am to 12pm, ET, [Call Info](#)
- 18 Apr 2022, 10am to 12pm, ET, [Call Info](#)

3. Optics Ad Hoc

- 27 Apr 2022, 10am to 12pm, ET, [Call Info](#)
- 14 Apr 2022, 10am to 12pm, ET, [Call Info](#)

January 2022 Electrical i/f Overview

Summary

- 100 Gbps/lane contributions needed
 - Baseline proposal thoughts for AUIs, BP, Cu cable, MDIs, etc.
- Initial 200 Gbps/lane contributions focus areas:
 - Host physical design/architecture
 - Use cases: FPP, CPO, NPO, combo AUI/CR port, Cu cable
 - “First order” channel contributions for equalization studies

March 2022 Session

Observations: Electrical

- Great progress on 100 Gbps/lane solutions!
 - Several open gaps remain: AN73, Link Training, MDI mappings, etc.
- C2M contributions show paths forward
 - Need more channel contributions
- Many presentations related to copper interfaces and cable assemblies
 - Discussion/analysis necessary
 - Need channel contributions
- Modulation choice (by interface/PMD type) is a big topic
 - Largest debate appears centered around CR solutions based on 200 Gbps / lane
- Proposed revision to COM package model for consideration

Need more contributions for April ad hocs

THANK YOU!



BACKUP



IEEE P802.3df Task Force Organization

	Leadership	Editorial Team
Task Force	John D'Ambrosia, Chair Mark Nowell, Vice-Chair	Matt Brown, Chief Editor
Logic Track	Mark Gustlin, Chair	Gary Nicholl, Lead Editor
Optics Track	Mark Nowell, Chair	Tom Issenhuth, Lead Editor
Electrical Track	Kent Lusted, Chair	Adee Ran, Lead Editor

The Role of the Chair / Vice Chair

- **Per the IEEE 802.3 Ethernet WG Operations Manual (http://www.ieee802.org/3/rules/P802_3_rules.pdf)**
 - **Per 3.4 - Operation of the Task Force**
 - **The operation of the TF has to be balanced between democratic procedures that reflect the desires of the TF members and the TF Chair's responsibility to produce a draft standard, recommended practice, or guideline in a reasonable amount of time for review and approval by the WG. Robert's Rules of Order shall be used in combination with these operating rules to achieve this balance.**
 - **The full responsibilities of the chair are specified in 3.4.3 Task Force Chair's Responsibilities.**
 - **The Role of the Vice Chair is specified in 3.2 –**
 - **There may be a TF Vice-Chair. A TF Vice-Chair carries out the TF Chair's duties if the TF Chair is temporarily unable to do so or chooses to delegate specific duties.**
- **Reminders –**
 - **We are a contribution driven organization. It should not be assumed by anyone that work will just get done without contributions to drive it. Areas not moving forward will be brought to the attention of the Task Force for consideration on how to address.**
 - **Individual standards activities within the WG are, at the discretion of the WG, carried out by Task Forces (TF) operating under, and reporting to, the WG.**

IEEE Structure

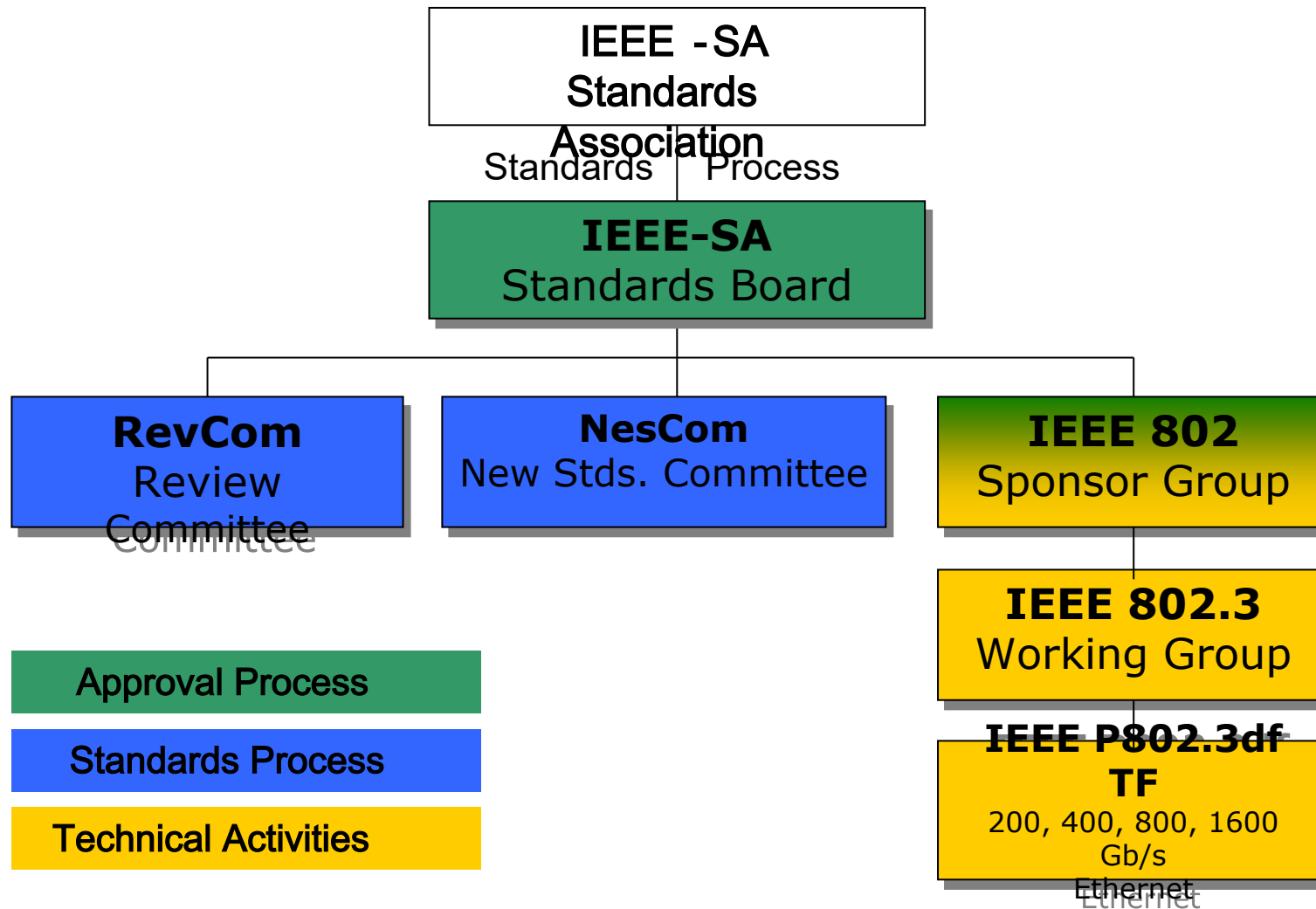

Important Bylaws, Rules, and References

- **IEEE-SA Operations Manual**
http://standards.ieee.org/develop/policies/sa_opman/
- **IEEE-SA Standards Board Bylaws**
<http://standards.ieee.org/develop/policies/bylaws/>
- **IEEE-SA Standards Board Operations Manual**
<http://standards.ieee.org/develop/policies/opman/>
- **IEEE 802 LAN/MAN Standards Committee (LMSC) Policies and Procedures**
<https://ieee.app.box.com/v/PandP-LMSC>
- **IEEE 802 LAN/MAN Standards Committee (LMSC) Operations Manual**
<http://www.ieee802.org/devdocs.shtml>
- **IEEE 802 LAN/MAN Standards Committee (LMSC) Working Group (WG) Policies and Procedures**
<http://www.ieee802.org/devdocs.shtml>
- **IEEE 802.3 Working Group Operating Rules**
http://ieee802.org/3/rules/P802_3_rules.pdf
- **“Promoting Competition and Innovation: What You Need to Know about the IEEE Standards Association's Antitrust and Competition Policy”**
<http://standards.ieee.org/develop/policies/antitrust.pdf>

Overview of IEEE 802.3 Standards Process (1/5)- Study Group Phase

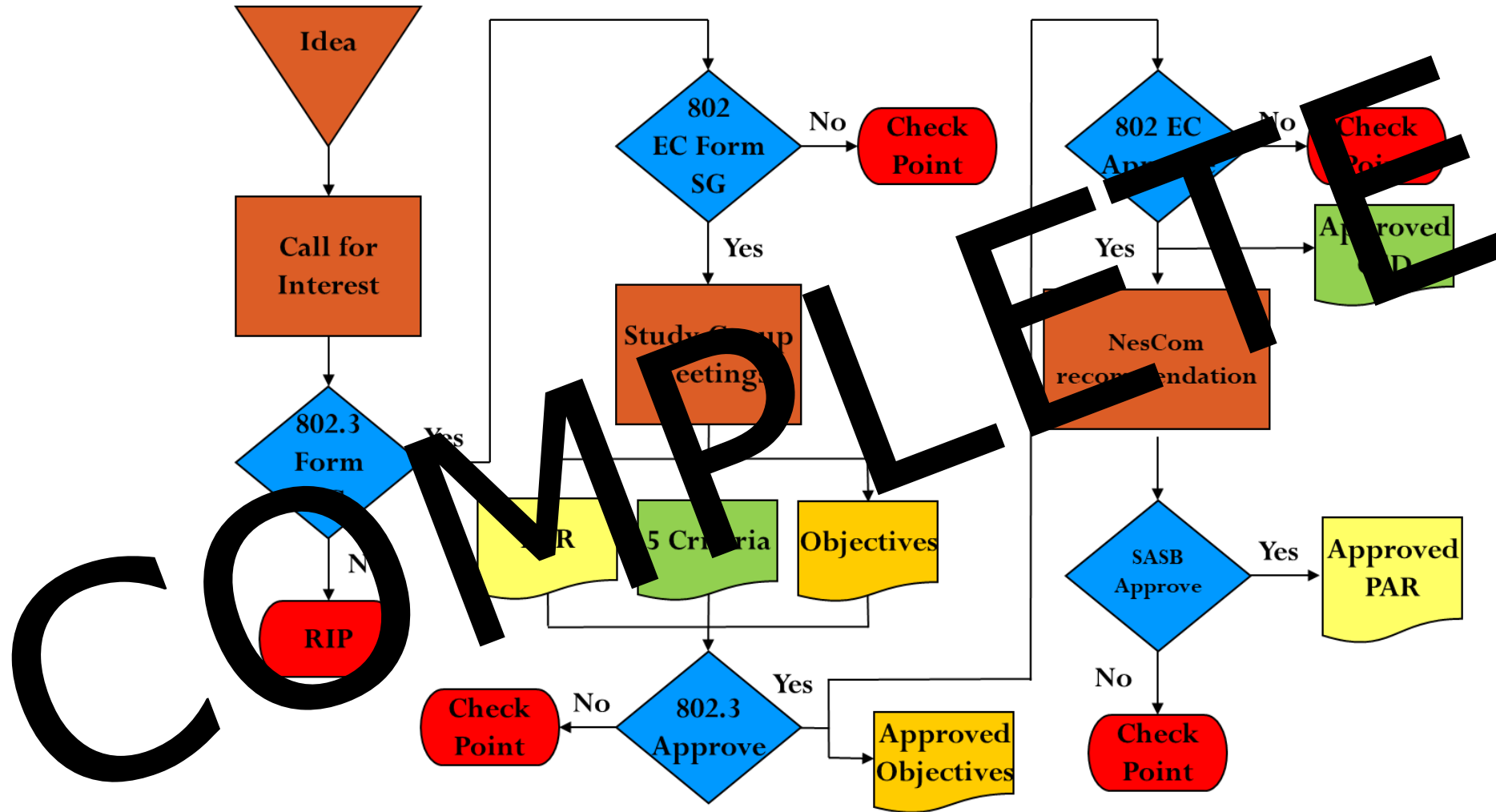

Note: At "Check Point", either the activity is ended, or there may be various options that would allow reconsideration of the approval.

Overview of IEEE 802.3 Standards Process (2/5) – Task Force Comment Phase

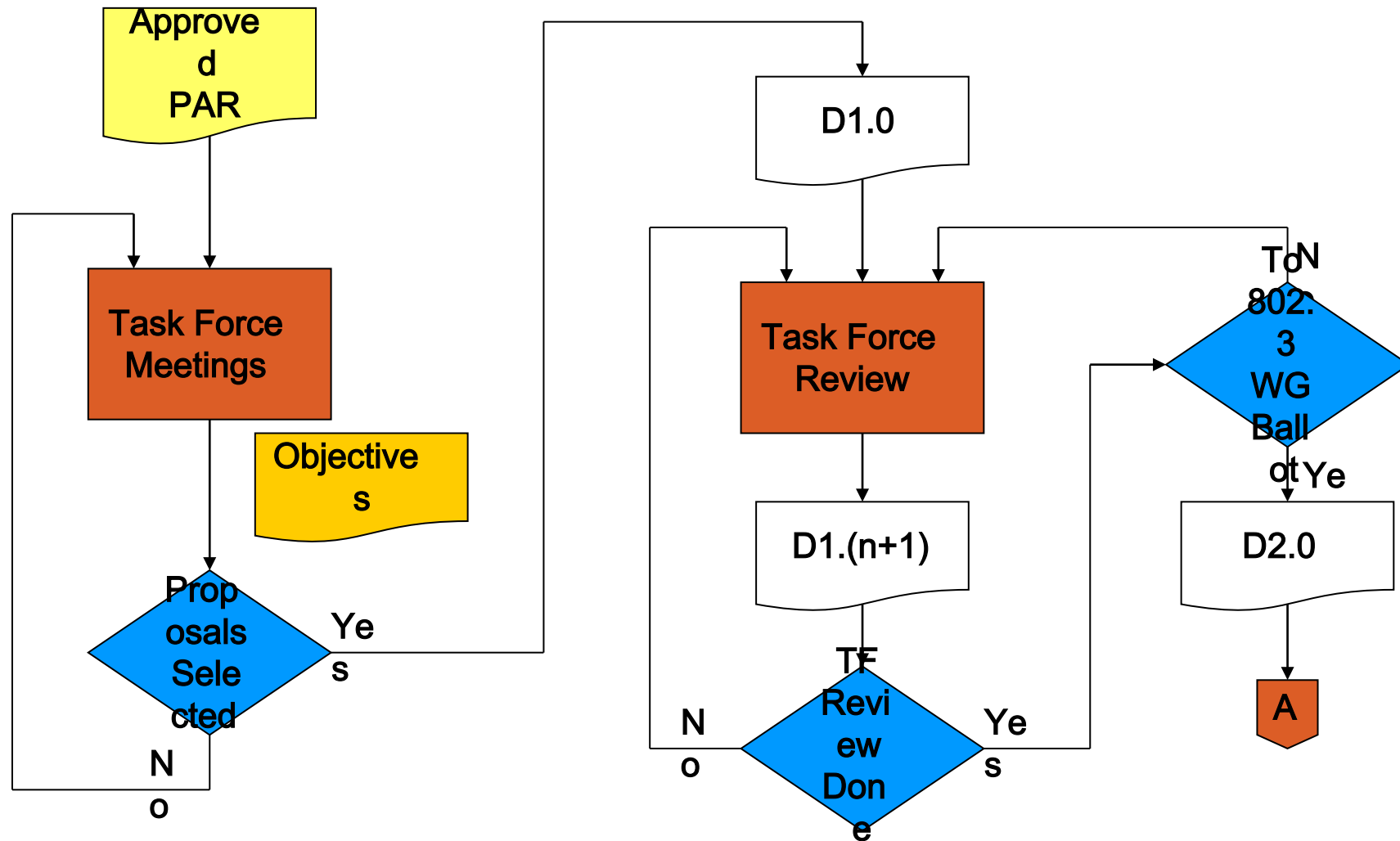

Overview of IEEE 802.3 Standards Process (3/5) – Working Group Ballot Phase

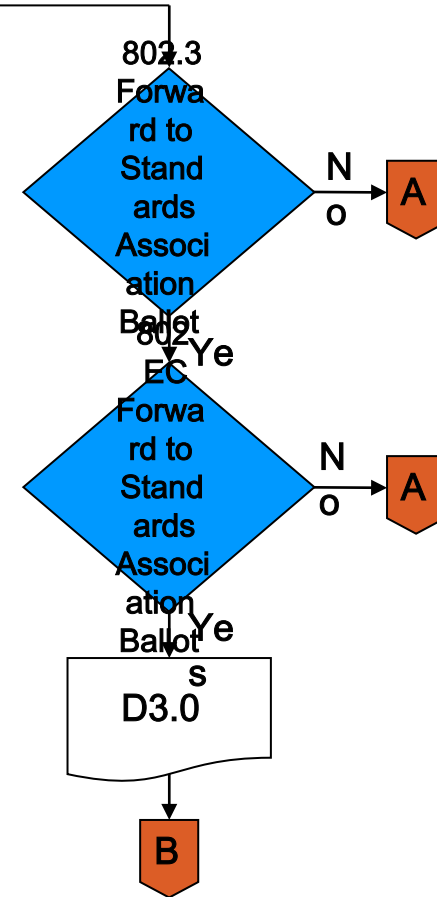
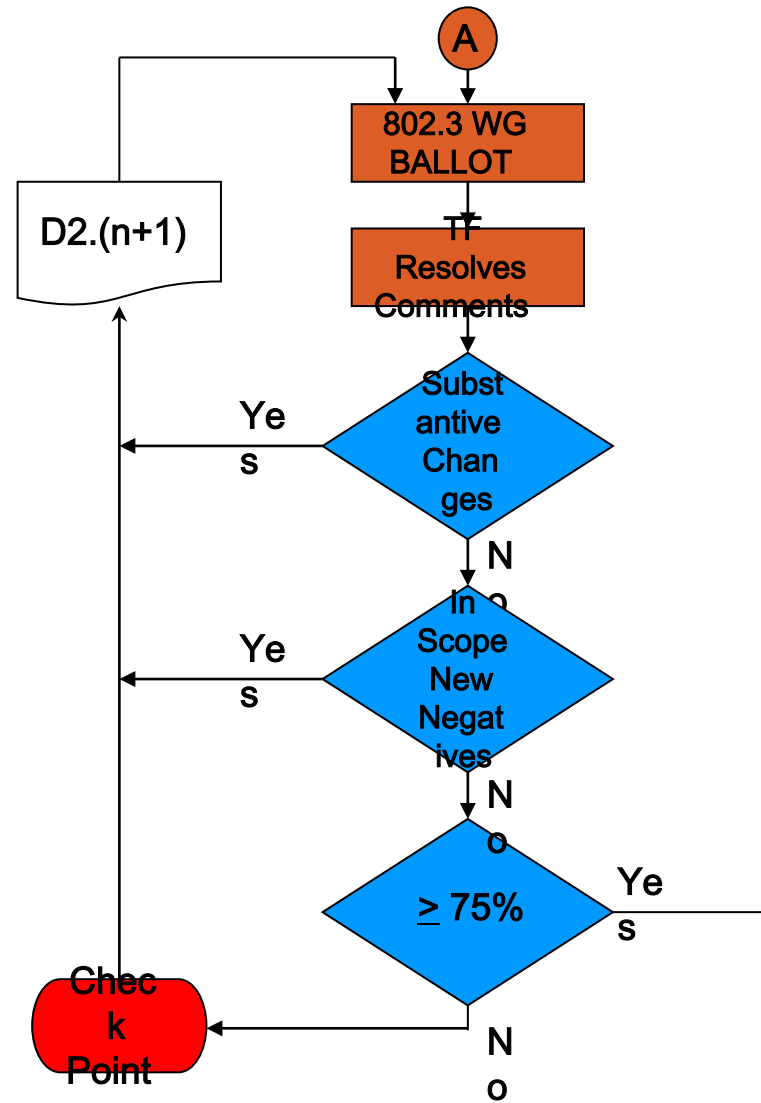

Notes: At "Check Point", either the activity is ended, or there may be various options that would allow reconsideration of the approval.
See 802.3 Operating Rules 2.6 and listed references for complete description

Overview of IEEE 802.3 Standards Process (4/5)- Standards Association (SA) Ballot Phase

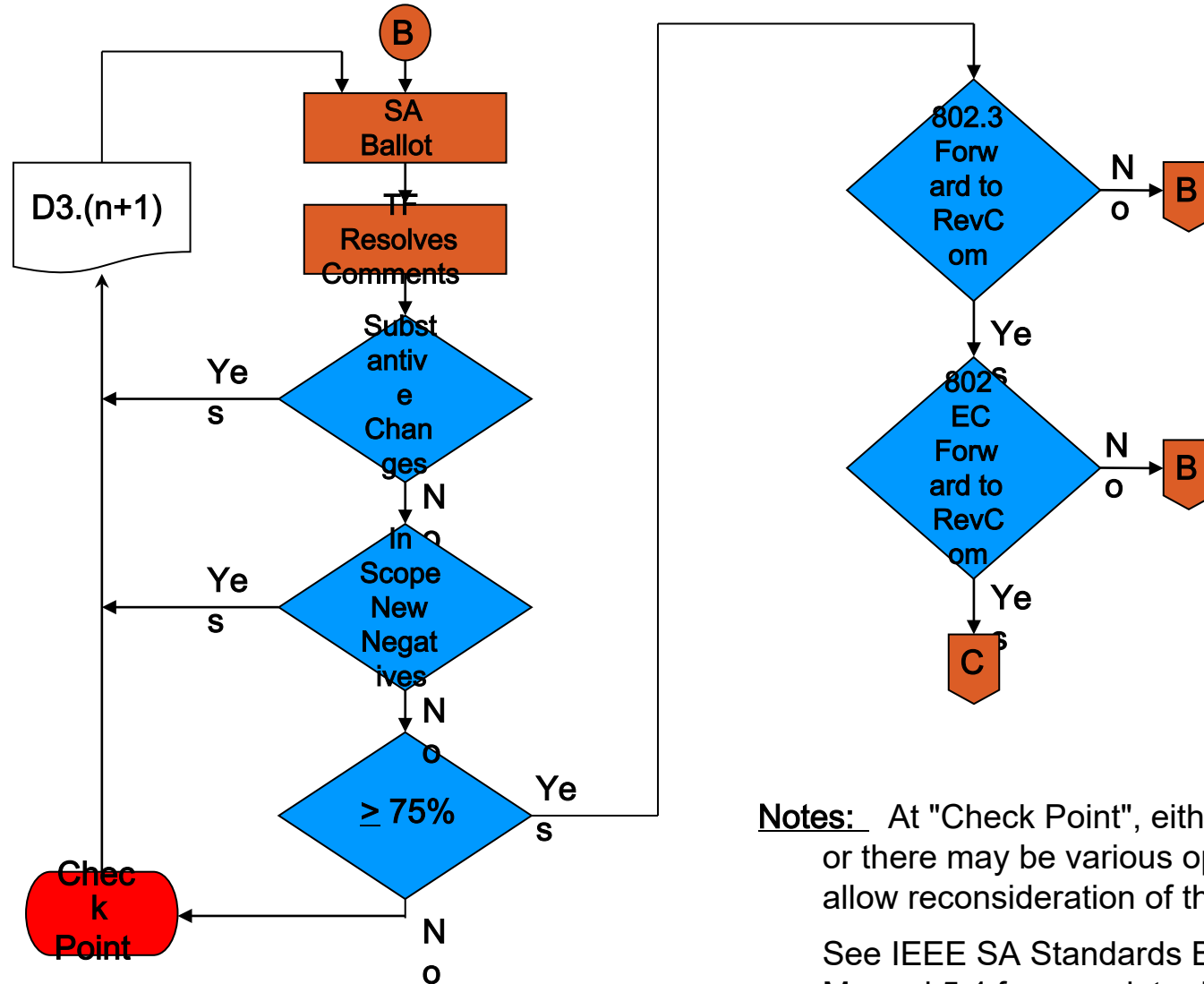

Notes: At "Check Point", either the activity is ended, or there may be various options that would allow reconsideration of the approval.

See IEEE SA Standards Board Operation Manual 5.4 for complete description.

Overview of IEEE 802.3 Standards Process (5/5) – Final Approvals / Standard Release

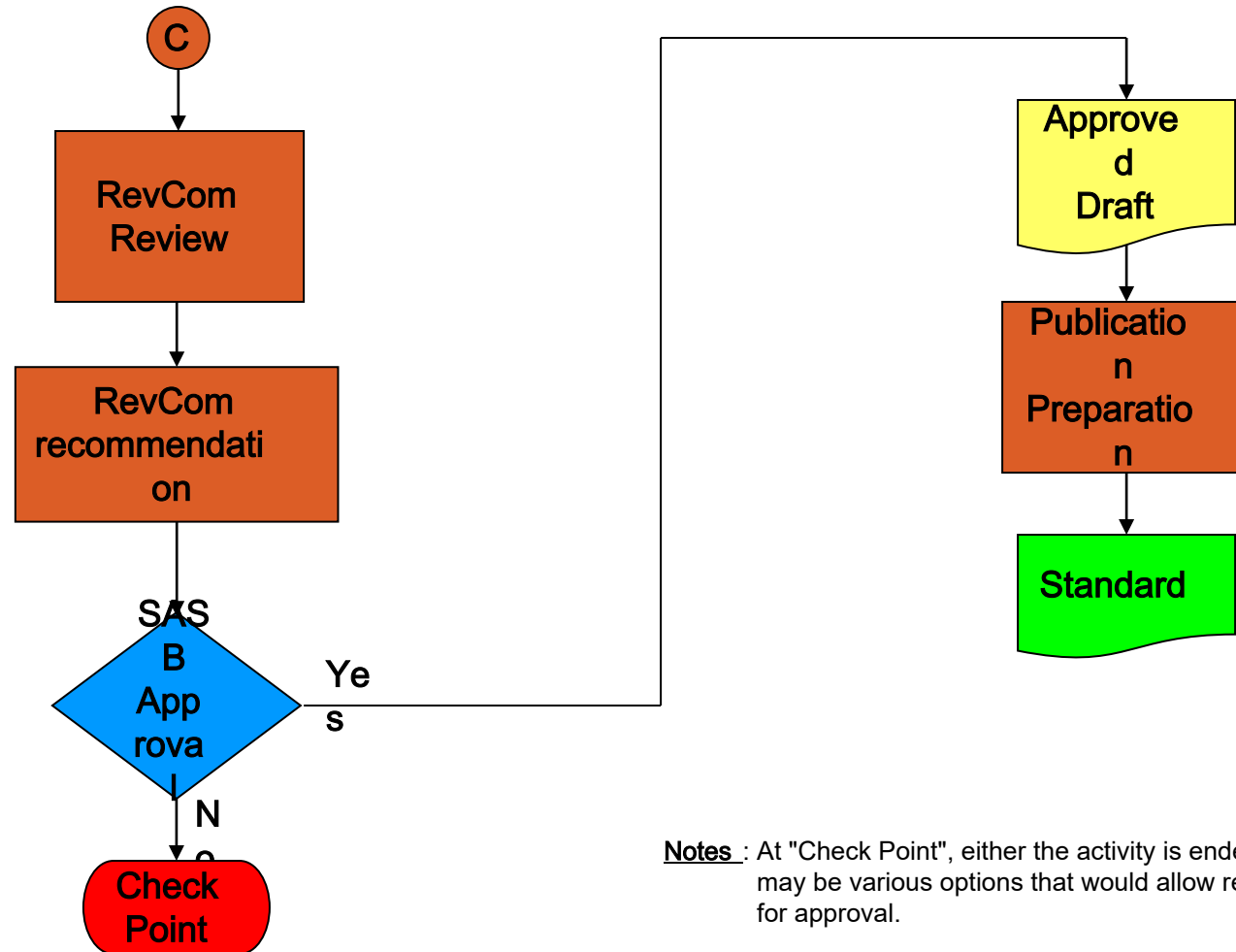

Notes : At "Check Point", either the activity is ended, or there may be various options that would allow resubmission for approval.

IEEE SA POLICIES

IEEE SA PATENT POLICY

Instructions for the WG Chair

The IEEE-SA strongly recommends that at each WG meeting the chair or a designee:

- Show slides #1 through #4 of this presentation
- Advise the WG attendees that:
 - IEEE's patent policy is described in Clause 6 of the *IEEE-SA Standards Board Bylaws*;
 - Early identification of patent claims which may be essential for the use of standards under development is strongly encouraged;
 - There may be Essential Patent Claims of which IEEE is not aware. Additionally, neither IEEE, the WG, nor the WG Chair can ensure the accuracy or completeness of any assurance or whether any such assurance is, in fact, of a Patent Claim that is essential for the use of the standard under development.
- Instruct the WG Secretary to record in the minutes of the relevant WG meeting:
 - That the foregoing information was provided and that slides 1 through 4 (and this slide 0, if applicable) were shown;
 - That the chair or designee provided an opportunity for participants to identify patent claim(s)/patent application claim(s) and/or the holder of patent claim(s)/patent application claim(s) of which the participant is personally aware and that may be essential for the use of that standard
 - Any responses that were given, specifically the patent claim(s)/patent application claim(s) and/or the holder of the patent claim(s)/patent application claim(s) that were identified (if any) and by whom.
- The WG Chair shall ensure that a request is made to any identified holders of potential essential patent claim(s) to complete and submit a Letter of Assurance.
- It is recommended that the WG Chair review the guidance in *IEEE-SA Standards Board Operations Manual* 6.3.5 and in FAQs 14 and 15 on inclusion of potential Essential Patent Claims by incorporation or by reference.

Note: WG includes Working Groups, Task Groups, and other standards-developing committees with a PAR approved by the IEEE-SA Standards Board.

Participants have a duty to inform the IEEE

- Participants shall inform the IEEE (or cause the IEEE to be informed) of the identity of each holder of any potential Essential Patent Claims of which they are personally aware if the claims are owned or controlled by the participant or the entity the participant is from, employed by, or otherwise represents
- Participants should inform the IEEE (or cause the IEEE to be informed) of the identity of any other holders of potential Essential Patent Claims

Early identification of holders of potential Essential Patent Claims is encouraged

Ways to inform IEEE

- Cause an LOA to be submitted to the IEEE-SA (patcom@ieee.org); or
- Provide the chair of this group with the identity of the holder(s) of any and all such claims as soon as possible; or
- Speak up now and respond to this Call for Potentially Essential Patents

If anyone in this meeting is personally aware of the holder of any patent claims that are potentially essential to implementation of the proposed standard(s) under consideration by this group and that are not already the subject of an Accepted Letter of Assurance, please respond at this time by providing relevant information to the WG Chair

Other guidelines for IEEE WG meetings

- All IEEE-SA standards meetings shall be conducted in compliance with all applicable laws, including antitrust and competition laws.
 - Don't discuss the interpretation, validity, or essentiality of patents/patent claims.
 - Don't discuss specific license rates, terms, or conditions.
 - Relative costs of different technical approaches that include relative costs of patent licensing terms may be discussed in standards development meetings.
 - Technical considerations remain the primary focus
 - Don't discuss or engage in the fixing of product prices, allocation of customers, or division of sales markets.
 - Don't discuss the status or substance of ongoing or threatened litigation.
 - Don't be silent if inappropriate topics are discussed ... do formally object.

For more details, see *IEEE-SA Standards Board Operations Manual*, clause 5.3.10 and *Antitrust and Competition Policy: What You Need to Know* at <http://standards.ieee.org/develop/policies/antitrust.pdf>

Patent-related information

The patent policy and the procedures used to execute that policy are documented in the:

- *IEEE-SA Standards Board Bylaws* (<http://standards.ieee.org/develop/policies/bylaws/sect6-7.html#6>)
- *IEEE-SA Standards Board Operations Manual*
(<http://standards.ieee.org/develop/policies/opman/sect6.html#6.3>)

Material about the patent policy is available at
<http://standards.ieee.org/about/sasb/patcom/materials.html>

**If you have questions, contact the IEEE-SA Standards Board
Patent Committee Administrator at patcom@ieee.org**

IEEE SA COPYRIGHT POLICY

November 2019

Instructions for Chairs of standards development activities

At the beginning of each standards development meeting the chair or a designee is to:

- Show the following slides (or provide them beforehand)
- Advise the standards development group participants that:
- IEEE SA's copyright policy is described in Clause 7 of the IEEE SA Standards Board Bylaws and Clause 6.1 of the IEEE SA Standards Board Operations Manual;
- Any material submitted during standards development, whether verbal, recorded, or in written form, is a Contribution and shall comply with the IEEE SA Copyright Policy;
- Instruct the Secretary to record in the minutes of the relevant meeting:
- That the foregoing information was provided and that the copyright slides were shown (or provided beforehand).

IEEE SA Copyright Policy

- **By participating in this activity, you agree to comply with the IEEE Code of Ethics, all applicable laws, and all IEEE policies and procedures including, but not limited to, the IEEE SA Copyright Policy.**
 - Previously Published material (copyright assertion indicated) shall not be presented/submitted to the Working Group nor incorporated into a Working Group draft unless permission is granted.
 - Prior to presentation or submission, you shall notify the Working Group Chair of previously Published material and should assist the Chair in obtaining copyright permission acceptable to IEEE SA.
 - For material that is not previously Published, IEEE is automatically granted a license to use any material that is presented or submitted.

IEEE SA Copyright Policy

- The IEEE SA Copyright Policy is described in the IEEE SA Standards Board Bylaws and IEEE SA Standards Board Operations Manual
- IEEE SA Copyright Policy, see
 - Clause 7 of the IEEE SA Standards Board Bylaws
<https://standards.ieee.org/about/policies/bylaws/sect6-7.html#7>
 - Clause 6.1 of the IEEE SA Standards Board Operations Manual
<https://standards.ieee.org/about/policies/opman/sect6.html>
- IEEE SA Copyright Permission
- <https://standards.ieee.org/content/dam/ieee-standards/standards/web/documents/other/permissionltrs.zip>
- IEEE SA Copyright FAQs
- <http://standards.ieee.org/faqs/copyrights.html/>
- IEEE SA Best Practices for IEEE Standards Development
- http://standards.ieee.org/develop/policies/best_practices_for_ieee_standards_development_051215.pdf
- Distribution of Draft Standards (see 6.1.3 of the SASB Operations Manual)
- <https://standards.ieee.org/about/policies/opman/sect6.html>

IEEE SA PARTICIPATION SLIDES

Participant behavior in IEEE-SA activities is guided by the IEEE Codes of Ethics & Conduct

- All participants in IEEE-SA activities are expected to adhere to the core principles underlying the:
 - [IEEE Code of Ethics](#)
 - [IEEE Code of Conduct](#)
- The core principles of the IEEE Codes of Ethics & Conduct are to:
 - *Uphold the highest standards of integrity, responsible behavior, and ethical and professional conduct*
 - *Treat people fairly and with respect, to not engage in harassment, discrimination, or retaliation, and to protect people's privacy.*
 - *Avoid injuring others, their property, reputation, or employment by false or malicious action*
- The most recent versions of these Codes are available at <http://www.ieee.org/about/corporate/governance>

Participants in the IEEE-SA *“individual process”* shall act independently of others, including employers

- The [IEEE-SA Standards Board Bylaws](#) require that *“participants in the IEEE standards development individual process shall act based on their qualifications and experience”*
- This means participants:
 - **Shall act & vote** based on their personal & independent opinions derived from their expertise, knowledge, and qualifications
 - **Shall not act or vote** based on any obligation to or any direction from any other person or organization, including an employer or client, regardless of any external commitments, agreements, contracts, or orders
 - **Shall not direct** the actions or votes of other participants or retaliate against other participants for fulfilling their responsibility to act & vote based on their personal & independently developed opinions
- By participating in standards activities using the *“individual process”*, you are deemed to accept these requirements; if you are unable to satisfy these requirements then you shall immediately cease any participation

IEEE-SA standards activities shall allow the fair & equitable consideration of all viewpoints

- The [IEEE-SA Standards Board Bylaws](#) (clause 5.2.1.3) specifies that *“the standards development process shall not be dominated by any single interest category, individual, or organization”*
 - This means no participant may exercise *“authority, leadership, or influence by reason of superior leverage, strength, or representation to the exclusion of fair and equitable consideration of other viewpoints”* or *“to hinder the progress of the standards development activity”*
- This rule applies equally to those participating in a standards development project and to that project’s leadership group
- Any person who reasonably suspects that dominance is occurring in a standards development project is encouraged to bring the issue to the attention of the Standards Committee or the project’s IEEE-SA Program Manager