

Rx Filter Redux

The presentation explores replacing the COM Rx filter with a raised cosine filter. Some benefits may be improvements in COM and reduced measurement bandwidth requirements.

Richard Mellitz, Samtec

Acknowledgement: Adam Gregory, Samtec

06-21-2022

Supporters

- John Calvin, Keysight

Agenda

- ❑ Introduction and Background
- ❑ 200 Gbps KR
- ❑ 200 Gbps C2M
- ❑ Summary

Higher Bandwidth Concerns

☐ Measurements

- How Much Bandwidth is Enough (HMBE) is a re-occurring theme

☐ High frequency ISI and crosstalk

- Small physical feature imperfections result in high frequency (> 60 GHz) ISI and crosstalk
- ... even after filtering with a Butterworth filter

☐ Consider the normalized spectral density of noise in the context of filtering

- Example Clause 162.9.4.3.4

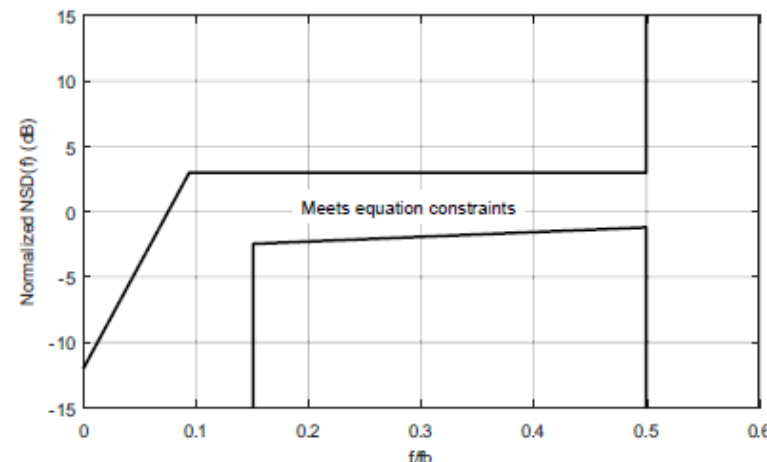

Figure 162-6—NSD(f) constraints

Experiment

EVALUATE IMPACT OF FILTERING

- ❑ Compare COM using KR/CR and C2M channel examples using Butterworth filters (BWF) and raised cosine filters (RCF).
 - RC does not denote resistor-capacitor in this presentation.
 - The RC filter is like the Turkey filter used for ERL computation
- ❑ The COM spreadsheets are not proposals per se
 - For C2M, aggressive and less aggressive COM configurations are considered.

Raised Cosine (RC) Low Pass Filter

EXAMPLE

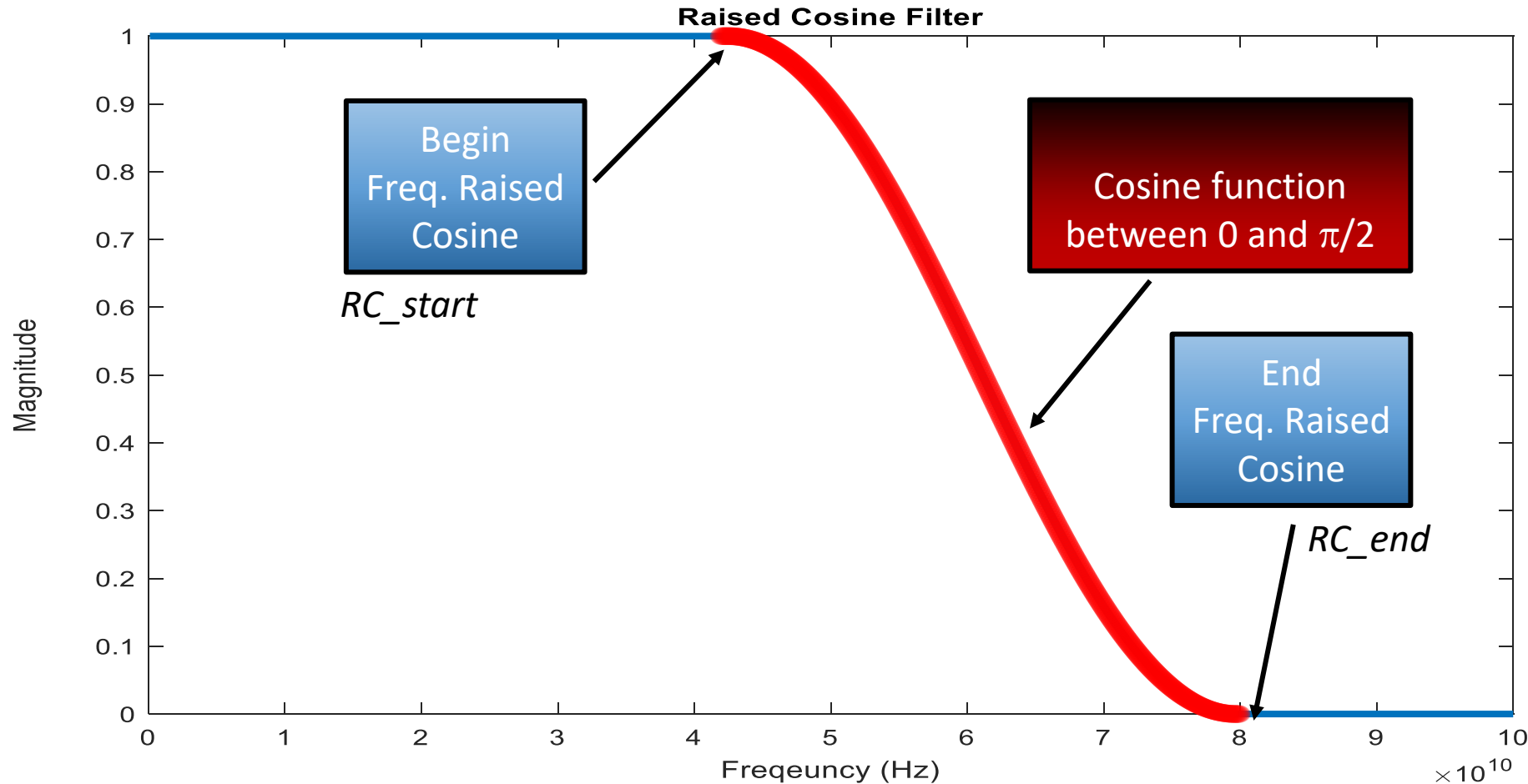

IL Comparison Between BWF and RCF

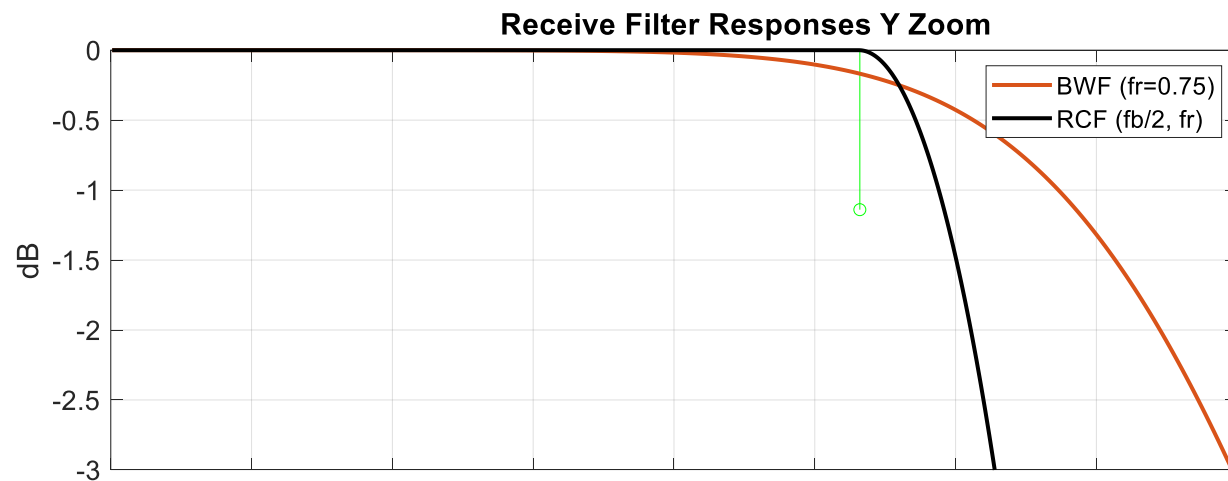
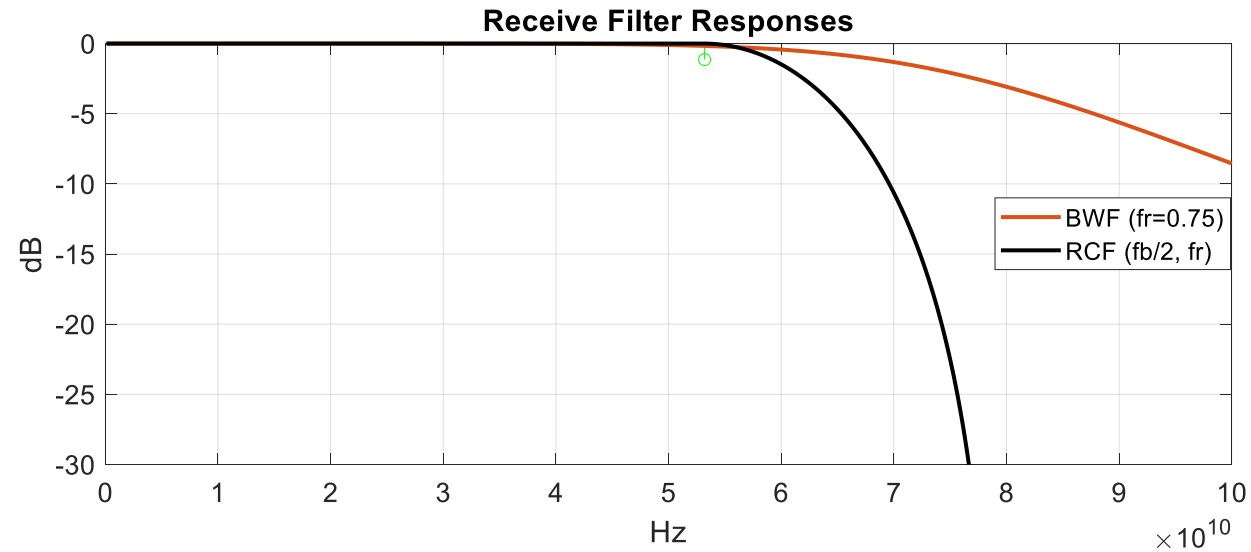

COM 3.8 Syntax Which Invokes the RC filter

EXAMPLE (THANKS TO ADAM GREGORY FOR THIS)

Raised_Cosine	0	logical	1 is an enable
Butterworth	1	logical	1 is an enable
RC_end	79.7E+9	Hz	End of Tukey range
RC_start	42.5E+9	Hz	Begin Tukey range

- ❑ 3 keywords added for the receive filter
- ❑ “Butterworth” was already implemented, and its default is 1
- ❑ “Raised_Cosine” is either 0 or 1 with a default as 0 which is not to enable
- ❑ RC_start and RC_end are illustrated on the prior slide. If Raised_Cosine is 1, RC_start and RC_end are used. The default for RC_start is $f_b/2$ and RC_end is $f_b * f_r$ if not specified.

Review: Reference Nomenclature Review

PURPOSE: ASSIST IN REVIEWING COM RESULTS

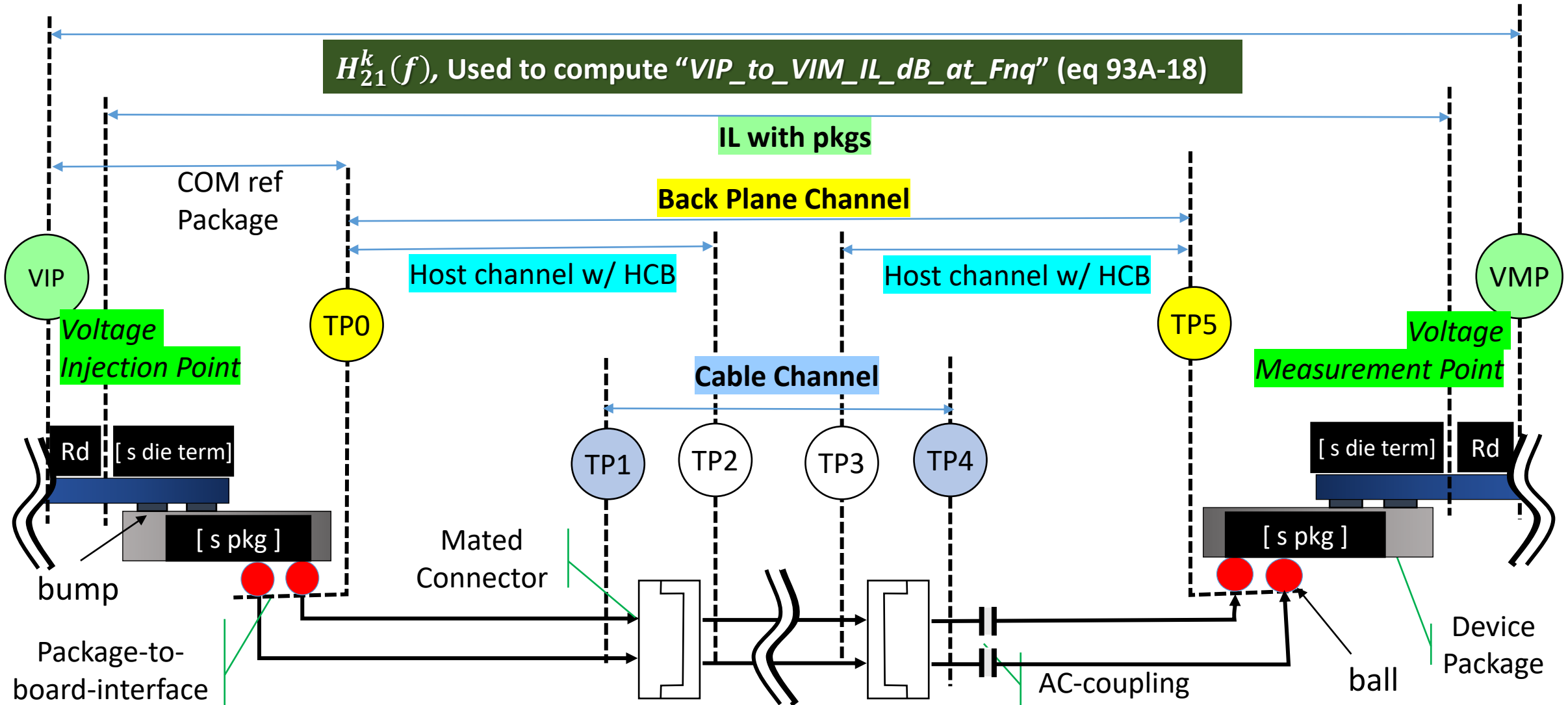

COM 3.8 Frequency Domain Graph

ADD PLOT OF AN UN-EQUALIZED VOLTAGE TRANSFER FUNCTION (VTF)

- New addition is the VTF curve (black)
 - VTF is equation 93A-19 but not including Tx or Rx equalization
 - $VTF(f) = H_t(f)H_{21}^0(f)H_r(f)$
- Purpose: Assist in channel and specification evaluation

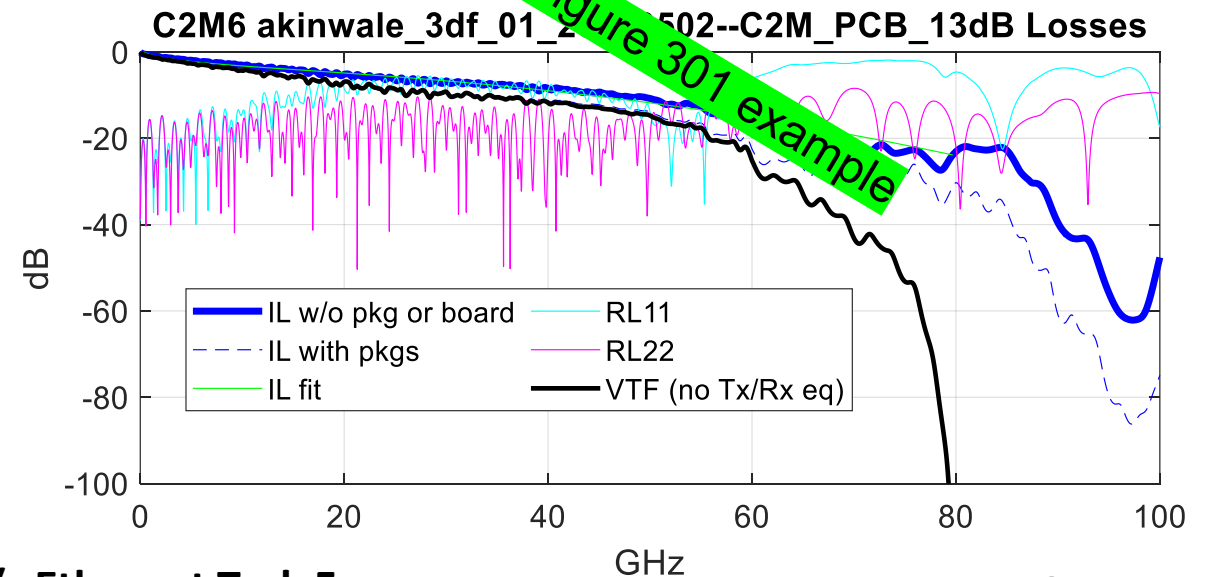
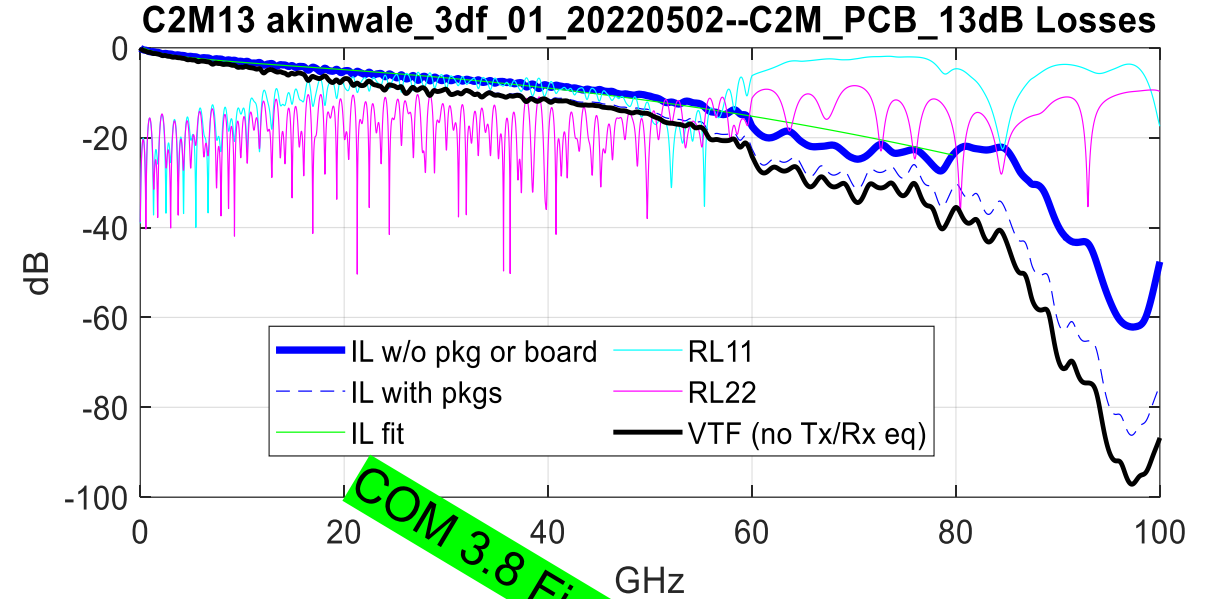

200G KR COM similar to li_3df_02_220322

Table 93A-1 parameters			2
Parameter	Setting	Units	Information
f_b	106.25	GBd	
f_min	0.05	GHz	
Delta_f	0.01	GHz	
C_d	[0.4e-4 0.9e-4 1.1e-4 ; 0.4e-4 0.9e-4 1.1e-4]	nF	[TX RX]
L_s	[.13 .15 .14; .13 .15 .14]	nH	[TX RX]
C_b	[.3e-4 .3e-4]	nF	[TX RX]
z_p select	[2]		[test cases to run]
z_p (TX)	[15 31; 1.8 1.8]	mm	[test cases]
z_p (NEXT)	[15 29; 1.8 1.8]	mm	[test cases]
z_p (FEXT)	[15 31; 1.8 1.8]	mm	[test cases]
z_p (RX)	[15 29; 1.8 1.8]	mm	[test cases]
C_p	[0.5e-4 0.5e-4]	nF	[TX RX]
R_0	50	Ohm	
R_d	[50 50]	Ohm	[TX RX]
A_v	0.408	V	
A_fe	0.408	V	
A_ne	0.608	V	
L	4		
M	32		
filter and Eq			
f_r	0.75	*fb	
c(0)	0.6		min
c(-1)	[-0.34:0.02:0]		[min:step:max]
c(-2)	[0:0.02:0.2]		[min:step:max]
c(-3)	[-0.1:0.02: 0]		[min:step:max]
c(1)	[-0.1:0.02:0]		[min:step:max]
N_b	24	UI	
b_max(1)	0.85		
b_max(2..N_b)	0.3		
b_min(1)	-0.85		
b_min(2..N_b)	-0.3		
g_DC	[-20:1:0]	dB	[min:step:max]
f_z	42.5	GHz	
f_p1	42.5	GHz	
f_p2	106.25	GHz	
g_DC_HP	[-8:1:0]		[min:step:max]
f_HP_PZ	1.0625	GHz	
Raised_Cosine	1	logical	1 is an enabel
Butterworth	0	logical	1 is an enabel
RC_end	79.7E+9	Hz	End of Tukey range
RC_start	42.5E+9	Hz	Begin Tukey range

I/O control		
DIAGNOSTICS	1	logical
DISPLAY_WINDOW	1	logical
CSV_REPORT	1	logical
RESULT_DIR	.\results\200G_kR_{date}\	
SAVE_FIGURES	0	logical
Port Order	[1 3 2 4]	
RUNTAG	R200_eval	
COM_CONTRIBUTION	0	logical
Operational		
COM Pass threshold	3	dB
ERL Pass threshold	10.5	dB
DER_0	1.00E-04	
T_r	2.50E-03	ns
FORCE_TR	1	logical
Local Search	2	
TDR and ERL options		
TDR	1	logical
ERL	1	logical
ERL_ONLY	0	logical
TR_TDR	0.01	ns
N	6000	
beta_x	0	
rho_x	0.618	
fixture delay time	[0 0]	[port1 port2]
TDR_W_TXPKG	0	
N_bx	36	UI
Z_t	50	ohm
Receiver testing		
RX_CALIBRATION	0	logical
Sigma BBN step	5.00E-03	V
Noise, jitter		
sigma_RJ	0.01	UI
A_DD	0.02	UI
eta_0	4.10E-09	V^2/GHz
SNR_TX	33	dB
R_LM	0.95	

Table 93A-3 parameters		
Parameter	Setting	Units
package_tl_gamma0_a1_a2	[0 8.4e-4 1.1e-4]	2.75 dB /in at 56G
package_tl_tau	6.14E-03	ns/mm
package_z_c	[87.5 87.5 ; 92.5 92.5]	Ohm
Table 92-12 parameters		
Parameter	Setting	Units
board_tl_gamma0_a1_a2	[0 6.44084e-4 3.6036e-05]	1.5 dbpi at 56G
board_tl_tau	0.00579	ns/mm
board_Z_c	100	Ohm
z_bp (TX)	40	mm
z_bp (NEXT)	40	mm
z_bp (FEXT)	40	mm
z_bp (RX)	40	mm
C_0	[0.2e-4]	nF
C_1	[0.1e-4]	nF
Include PCB	0	logical
Floating Tap Control		
N_bg	3	0 1 2 or 3 groups
N_bf	6	taps per group
N_f	60	UI span for floating taps
bmaxg	0.2	max DFE value for floating taps
B_float_RSS_MAX	0.2	rss tail tap limit
N_tail_start	25	(UI) start of tail taps limit
ICN parameters		
f_v	0.890	*Fb
f_f	0.890	*Fb
f_n	0.890	*Fb
f_2	79.688	GHz
A_ft	0.600	V
A_nt	0.600	V

This was used for comparative analysis and is not a proposal per se.

KR analysis Used Available Files

- ❑ Strategy: consider relative comparisons
- ❑ Start with 9 channels from mellitz_3df_elec_01_220502

Proto-type Grade KR channels

mellitz_3df_elec_01_220502 (36 channels w/o crosstalk)

End of
line test
point

1.0 mm
"SMA"

1.85 mm
"SMA"

Layer 28
via with
break out

2" 5" 8" 0.5 1.0 1.5 m cable

```
""For_3df_noxtk--Via_28mm__12dB_1000mm_NVAC_thru""  
""For_3df_noxtk--Via_28mm__12dB_1500mm_NVAC_thru""  
""For_3df_noxtk--Via_28mm__12dB_500mm_NVAC_thru""  
""For_3df_noxtk--Via_28mm__3.2dB_1000mm_NVAC_thru""  
""For_3df_noxtk--Via_28mm__3.2dB_1500mm_NVAC_thru""  
""For_3df_noxtk--Via_28mm__3.2dB_500mm_NVAC_thru""  
""For_3df_noxtk--Via_28mm__8dB_1000mm_NVAC_thru""  
""For_3df_noxtk--Via_28mm__8dB_1500mm_NVAC_thru""  
""For_3df_noxtk--Via_28mm__8dB_500mm_NVAC_thru""
```

TPO

TP5

COM Comparison Between RCF and BWF

TP0/TP5 LAYER 11 BOARD VIA

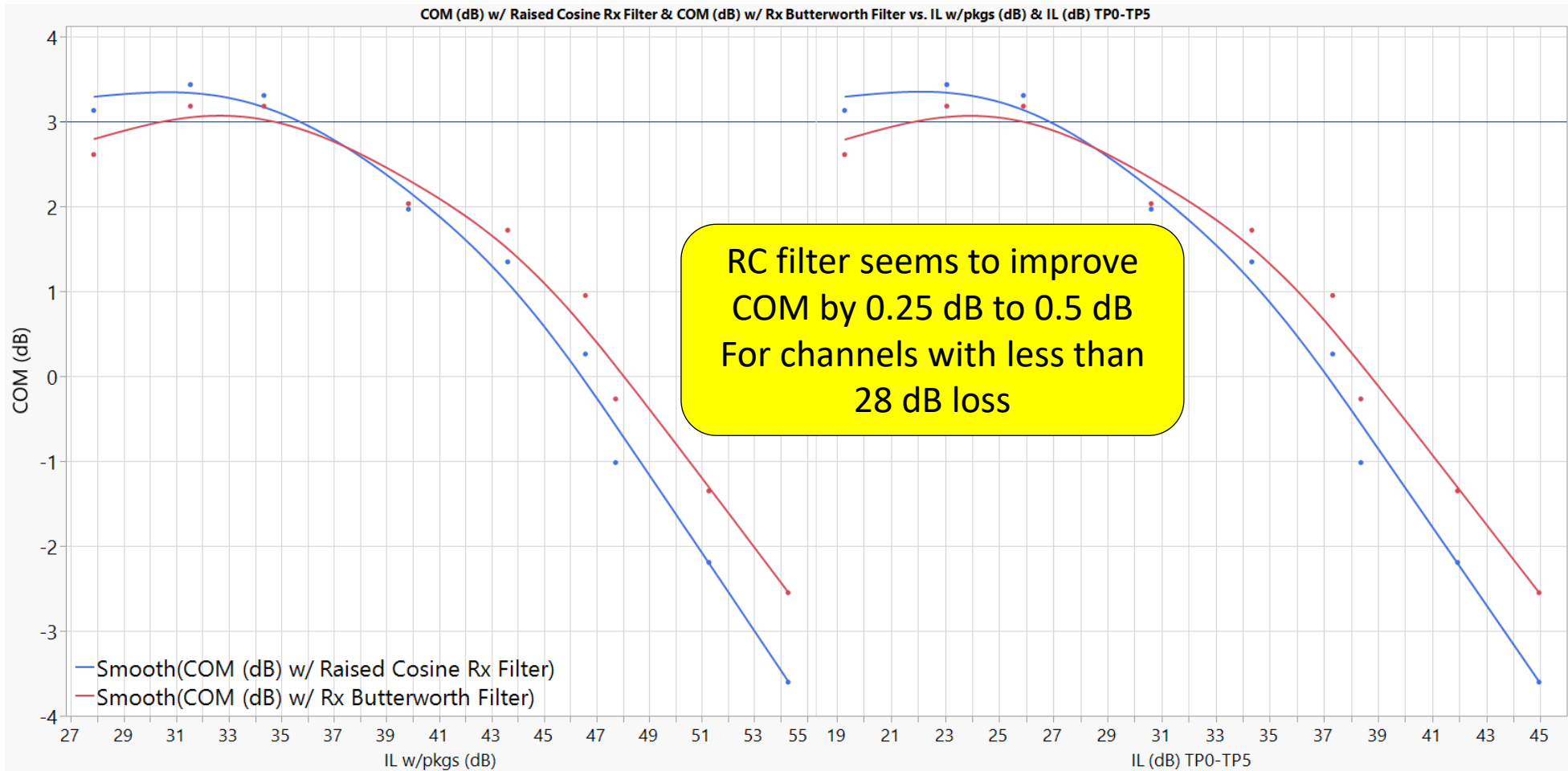

C2M files

Posted 0.3df C2M files: Crosstalk is used

- ❑ rabinovich_3df_022422:
KEY_C2M_200G_120G_2p5HCB_022422_Thru.s4p
- ❑ rabinovich_3df_022422:
KEY_C2M_200G_120G_4p0HCB_022422_Thru.s4p
- ❑ akinwale_3df_01_20220502: C2M_PCB_10dB.s4p
- ❑ akinwale_3df_01_20220502: C2M_PCB_11dB.s4p
- ❑ akinwale_3df_01_20220502: C2M_PCB_12dB.s4p
- ❑ akinwale_3df_01_20220502: C2M_PCB_13dB.s4p

KR vs C2M experiment differences

- ❑ Raised cosine bandwidth
 - KR: RC_Start is defaulted to $f_b/2$
 - C2M: RC_Start is defaulted to $f_b/2.5$
 - RC_end is defaulted to $f_b * f_r$
- ❑ C2M Comparison uses VEC and EH between RCF (raised cosine filter) and BWF (Butterworth filter), not COM
- ❑ 2 C2M Configuration templates
 - Aggressive
 - 3 groups of 6 floating taps
 - Higher SNR_Tx: 34 dB
 - Higher DER0: 5e-5
 - Less Aggressive
 - no floating taps
 - lower SNR_Tx: 32.5 dB
 - lower DER0 1e-5

Less Aggressive C2M Configuration Template

Table 93A-1 parameters			
Parameter	Setting	Units	Information
f_b	106.25	GBd	
f_min	0.05	GHz	
Delta_f	0.01	GHz	
C_d	[0.4e-4 0.9e-4 1.1e-4 ;0 0 0]	nF	[TX RX]
L_s	[.12 .15 .14 ;0 0 0]	nH	[TX RX]
C_b	[.3e-4 0]	nF	[TX RX]
z_p select	[1 2]		[test cases to run]
z_p (TX)	[15 31; 1.8 1.8]	mm	[test cases]
z_p (NEXT)	[0 0; 0 0]	mm	[test cases]
z_p (FEXT)	[15 31; 1.8 1.8]	mm	[test cases]
z_p (RX)	[0 0; 0 0]	mm	[test cases]
C_p	[0.4e-4 0]	nF	[TX RX]
R_0	50	Ohm	
R_d	[50 50]	Ohm	[TX RX]
A_v	0.408	V	vp/vf=
A_fe	0.408	V	vp/vf=
A_ne	0.608	V	
L	4		
M	32		
filter and Eq			
f_r	0.75	*fb	
c(0)	0.65		min
c(-1)	[-0.2:0.02:0]		[min:step:max]
c(-2)	[0:.02:0.1]		[min:step:max]
c(-3)	[-0.1:.02:0]		[min:step:max]
c(1)	[-0.2:0.02:0]		[min:step:max]
N_b	8	UI	
b_max(1)	0.85		As/dffe1
b_max(2..N_b)	0.15		As/dfe2..N_b
b_min(1)	0		As/dffe1
b_min(2..N_b)	-0.15		As/dfe2..N_b
g_DC	[-13:1:0]	dB	[min:step:max]
f_z	42.5	GHz	
f_p1	42.5	GHz	
f_p2	106.25	GHz	
g_DC_HP	[-6:1:0]		[min:step:max]
f_HP_PZ	1.0625	GHz	
Receiver testing			
RX_CALIBRATION	0	logical	
Sigma BBN step	5.00E-03	V	
Raised_Cosine	0	logical	1 is an enable
Butterworth	1	logical	1 is an enable

I/O control		
DIAGNOSTICS	1	logical
DISPLAY_WINDOW	1	logical
CSV_REPORT	1	logical
RESULT_DIR	.\results\c2m106_{date}\	
SAVE_FIGURES	0	logical
Port Order	[1 3 2 4]	
RUNTAG	C2M TP1a	
COM_CONTRIBUTION	0	logical
Operational		
ERL Pass threshold	10	dB
VEC Pass threshold	12.5	db
DER_0	1.00E-05	
T_r	2.35E-03	ns
FORCE_TR	1	logical
Min_VEO_Test	1	mV
PHY_type	C2M	
EH_min	10	Value
EH_max	1000	Value
T_0	50	mUI
samples_for_C2M	100	samples/UI
Dynamic TXFFE	1	
FloatingDFE_Development	1	
EW	1	
TDR and ERL options		
TDR	1	logical
ERL	1	logical
ERL_ONLY	0	logical
TR_TDR	0.01	ns
N	6000	
TDR_Butterworth	1	logical
beta_x	0	
rho_x	0.618	
TDR_W_TXPKG	0	
N_bx	8	UI
fixture delay time	[0 0.2e-9]	
Tukey_Window	1	
Noise, jitter		
sigma_RJ	0.01	UI
A_DD	0.02	UI
eta_0	2.05E-08	V^2/GHz
SNR_TX	32.5	dB
R_LM	0.95	

Table 93A-3 parameters		
Parameter	Setting	Units
package_tl_gamma0_a1_a2	[0 8.4e-4 1.1e-4]	2.75 dB/in at 56G
package_tl_tau	6.14E-03	ns/mm
package_Z_c	[87.5 87.5 ; 92.5 92.5]	Ohm
Parameter Setting		
board_tl_gamma0_a1_a2	[0 6.44084e-4 3.6036e-05]	1.5 db/in @ 56G
board_tl_tau	5.790E-03	ns/mm
board_Z_c	100	Ohm
z_bp (TX)	50	mm
z_bp (NEXT)	0	mm
z_bp (FEXT)	50	mm
z_bp (RX)	0	mm
C_0	[0.2e-4 0]	nF
C_1	[0.2e-4 0]	nF
Include PCB	0	logical
Seleions (rectangle, gaussian,dual_rayleigh,triangle		
Histogram_Window_Weight	gaussian	
QL	2.5	
ICN parameters		
f_v	0.278	Fb
f_f	0.278	Fb
f_n	0.278	Fb
f_2	79.688	GHz
A_ft	0.450	V
A_nt	0.450	V
Floating Tap Control		
N_bg	0	0 1 2 or 3 groups
N_bf	6	taps per group
N_f	64	span for floating tap
bmaxg	0.05	DFE value for floating
B_float_RSS_MAX	0.02	rss tail tap limit
N_tail_start	9	l) start of tail taps lin

Aggressive C2M Configuration Template

Table 93A-1 parameters			
Parameter	Setting	Units	Information
f_b	106.25	Gbd	
f_min	0.05	GHz	
Delta_f	0.01	GHz	
C_d	[0.4e-4 0.9e-4 1.1e-4;0 0 0]	nF	[TX RX]
L_s	[.12 .15 .14; 0 0 0]	nH	[TX RX]
C_b	[.3e-4 0]	nF	[TX RX]
z_p_select	[1 2]		[test cases to run]
z_p (TX)	[15 31; 1.8 1.8]	mm	[test cases]
z_p (NEXT)	[0 0; 0 0]	mm	[test cases]
z_p (FEXT)	[15 31; 1.8 1.8]	mm	[test cases]
z_p (RX)	[0 0; 0 0]	mm	[test cases]
C_p	[0.4e-4 0]	nF	[TX RX]
R_0	50	Ohm	
R_d	[50 50]	Ohm	[TX RX]
A_v	0.408	V	vp/vf=
A_fe	0.408	V	vp/vf=
A_ne	0.608	V	
L	4		
M	32		
filter and Eq			
f_r	0.75	*fb	
c(0)	0.65		min
c(-1)	[-0.2:0.02:0]		[min:step:max]
c(-2)	[0:.02:0.1]		[min:step:max]
c(-3)	[-0.1:.02:0]		[min:step:max]
c(1)	[-0.2:0.02:0]		[min:step:max]
N_b	8	UI	
b_max(1)	0.85		As/dffe1
b_max(2..N_b)	0.15		As/dfe2..N_b
b_min(1)	0		As/dffe1
b_min(2..N_b)	-0.15		As/dfe2..N_b
g_DC	[-13:1:0]	dB	[min:step:max]
f_z	42.5	GHz	
f_p1	42.5	GHz	
f_p2	106.25	GHz	
g_DC_HP	[-6:1:0]		[min:step:max]
f_HP_PZ	1.0625	GHz	
Receiver testing			
RX_CALIBRATION	0	logical	
Sigma BBN step	5.00E-03	V	
Raised_Cosine	0	logical	1 is an enable
Butterworth	1	logical	1 is an enable

I/O control		
DIAGNOSTICS	1	logical
DISPLAY_WINDOW	1	logical
CSV_REPORT	1	logical
RESULT_DIR	.\results\c2m106_{date}\	
SAVE_FIGURES	0	logical
Port Order	[1 3 2 4]	
RUNTAG	C2M TP1a	
COM_CONTRIBUTION	0	logical
Operational		
ERL Pass threshold	10	dB
VEC Pass threshold	12.5	db
DER_0	5.00E-05	
T_r	2.35E-03	ns
FORCE_TR	1	logical
Min_VEO Test	1	mV
PHY_type	C2M	
EH_min	10	Value
EH_max	1000	Value
T_O	50	mUI
samples_for_C2M	100	samples/UI
Dynamic TXFFE	1	
FloatingDFE_Development	1	
EW	1	
TDR and ERL options		
TDR	1	logical
ERL	1	logical
ERL_ONLY	0	logical
TR_TDR	0.01	ns
N	6000	
TDR Butterworth	1	logical
beta_x	0	
rho_x	0.618	
TDR_W_TXPKG	0	
N_bx	8	UI
fixture delay time	[0 0.2e-9]	
Tukey_Window	1	
Noise, jitter		
sigma_RJ	0.01	UI
A_DD	0.02	UI
eta_0	2.05E-09	V^2/GHz
SNR_TX	34	dB
R_LM	0.95	

Table 93A-3 parameters		
Parameter	Setting	Units
package_tl_gamma0_a1_a2	[0 8.4e-4 1.1e-4]	2.75 dB/in at 56G
package_tl_tau	6.14E-03	ns/mm
package_Z_c	[87.5 87.5 ; 92.5 92.5]	Ohm
Seletions (rectangle, gaussian,dual_rayleigh,triangle		
board_tl_gamma0_a1_a2	[0 6.44084e-4 3.6036e-05]	1.5 db/in @ 56G
board_tl_tau	5.790E-03	ns/mm
board_Z_c	100	Ohm
z_bp (TX)	125	mm
z_bp (NEXT)	0	mm
z_bp (FEXT)	125	mm
z_bp (RX)	0	mm
C_0	[0.2e-4 0]	nF
C_1	[0.2e-4 0]	nF
Include PCB	0	logical

Seletions (rectangle, gaussian,dual_rayleigh,triangle		
Histogram_Window_Weight	gaussian	
QL	2.5	

ICN parameters		
f_v	0.278	Fb
f_f	0.278	Fb
f_n	0.278	Fb
f_2	79.688	GHz
A_ft	0.450	V
A_nt	0.450	V

Floating Tap Control		
N_bg	6	0 1 2 or 3 groups
N_bf	3	taps per group
N_f	64	UI span for floating taps
bmaxg	0.2	max DFE value for floating
B_float_RSS_MAX	0.1	rss tail tap limit
N_tail_start	9	(UI) start of tail taps limit

EH improves using RCF

THE 2ND AND 4TH BARS ARE BWF AND WORSE EH

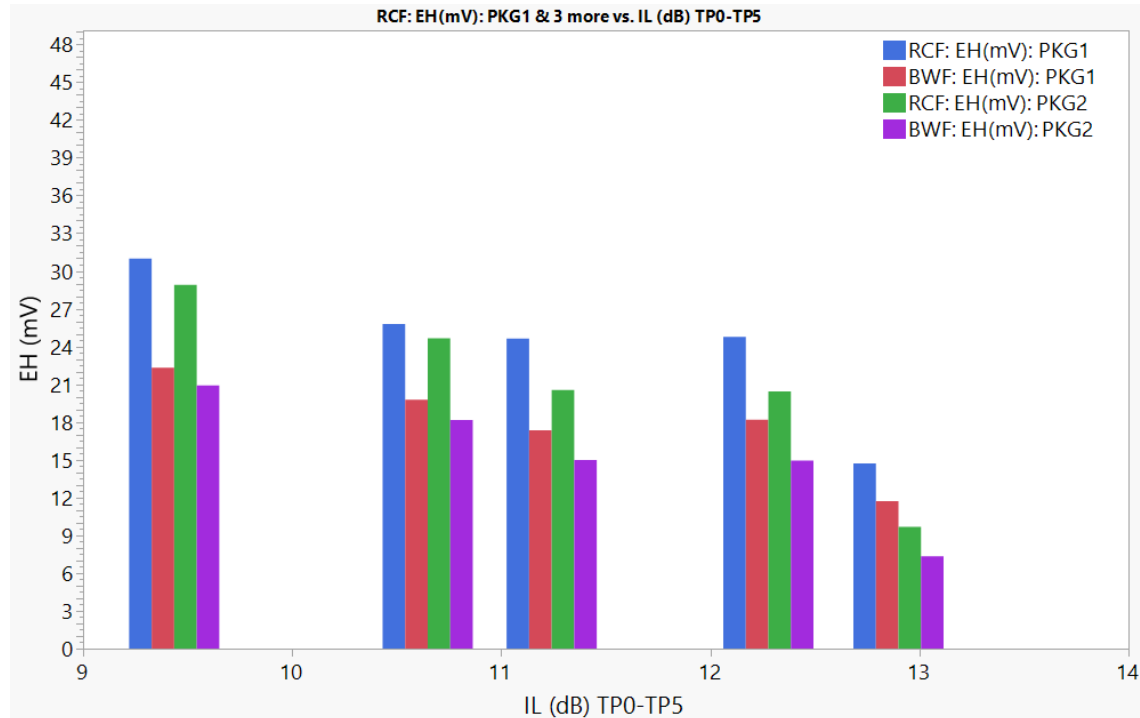

Aggressive C2M Configuration

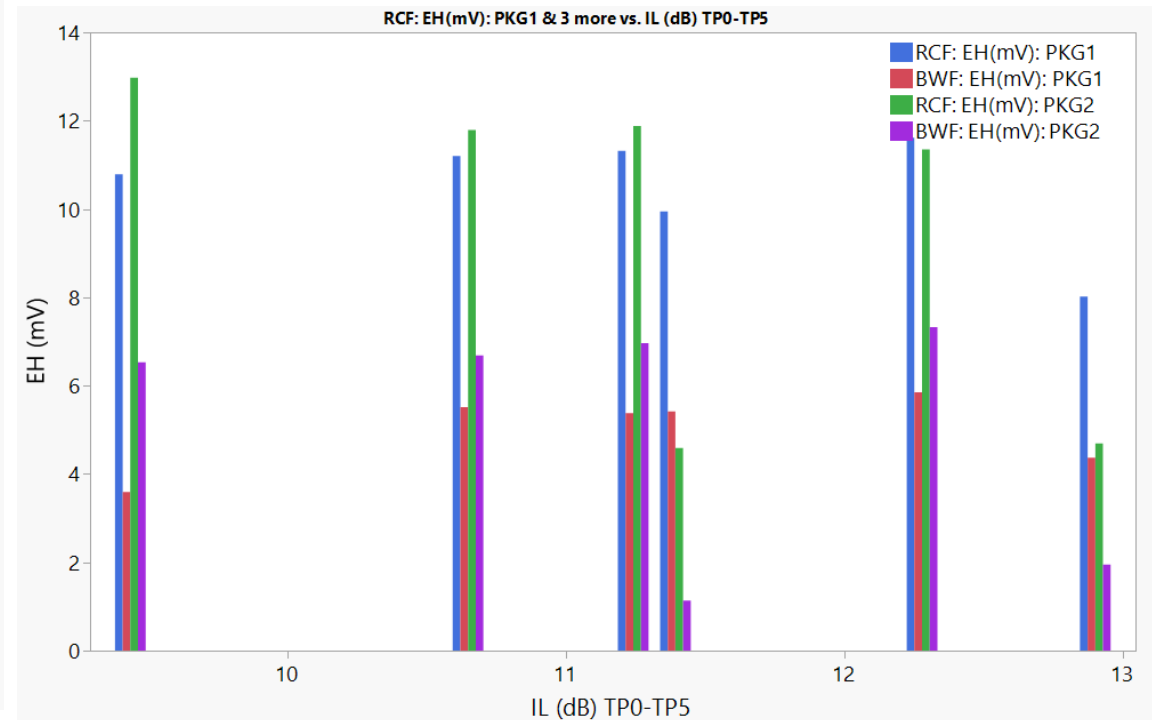

Less Aggressive C2M Configuration

VEC improves using RCF

THE 2ND AND 4TH BARS ARE BWF AND WORSE VEC

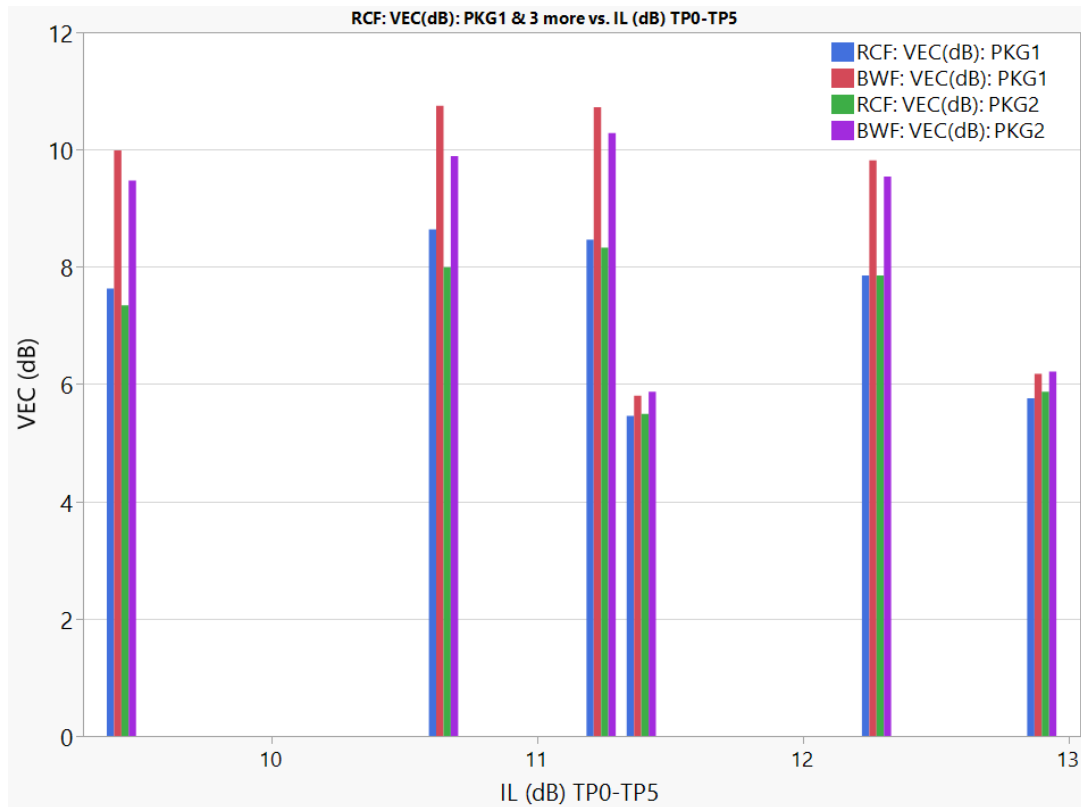

Aggressive C2M Configuration

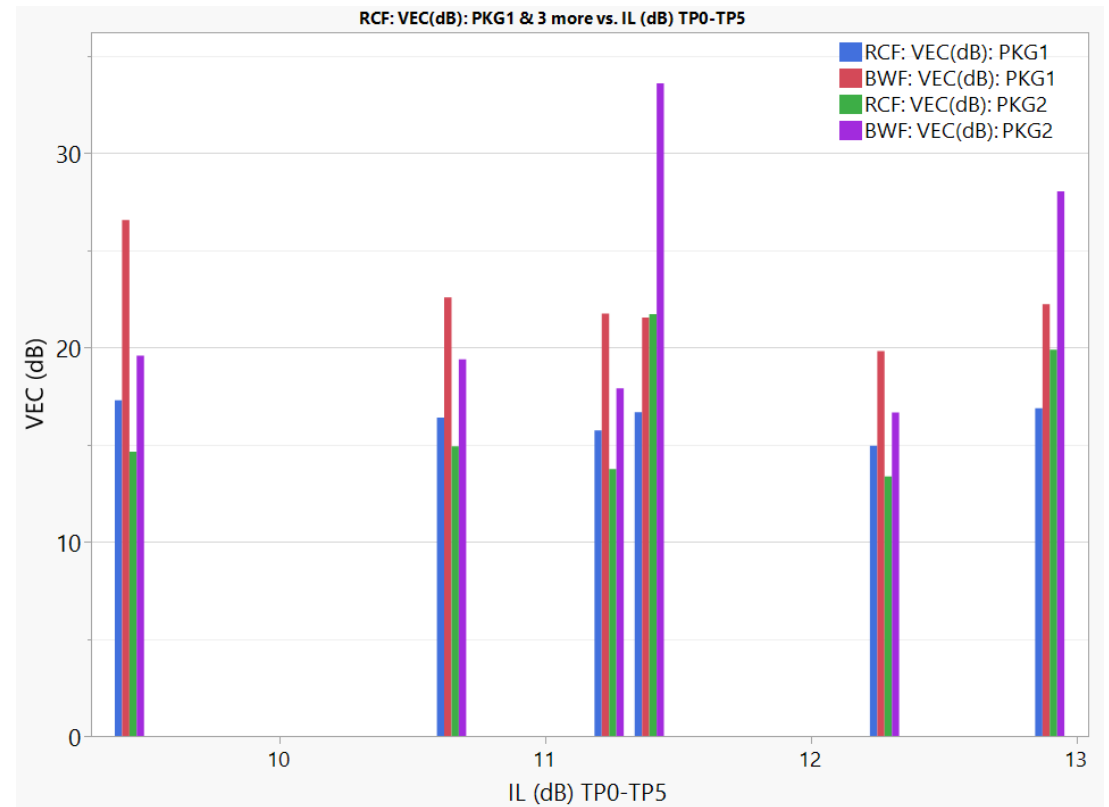

Less Aggressive C2M Configuration

One more experiment

SELECT THE 13 DB CHANNEL

Less Aggressive C2M Configuration

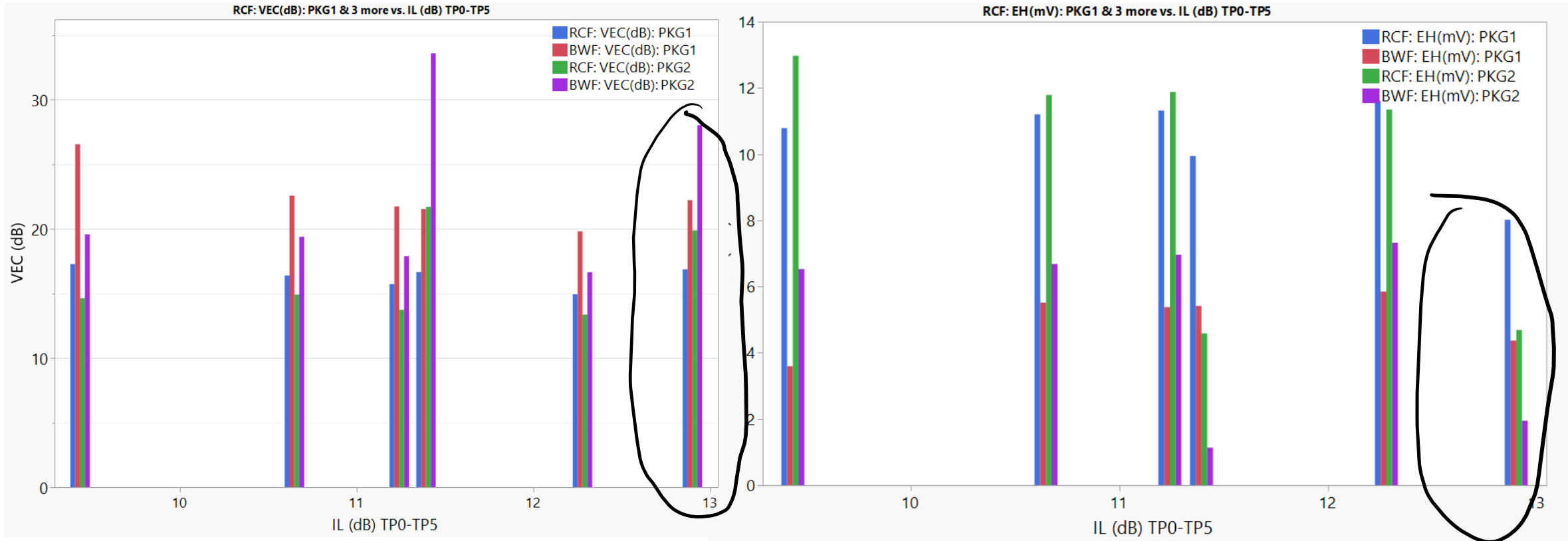

Reduce BWF Bandwidth (f_r) from $0.75f_b$ to $0.5f_b$

THE 2ND AND 4TH BARS ARE BWF AND WORSE VEC AND EH

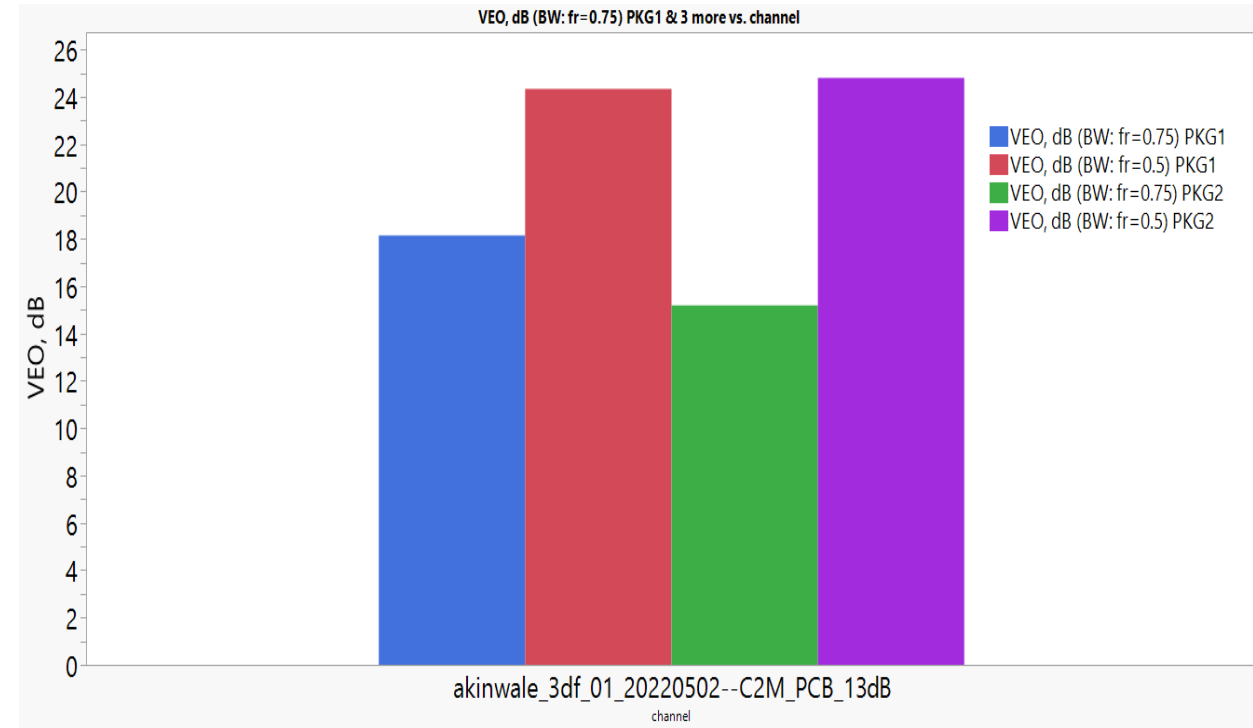
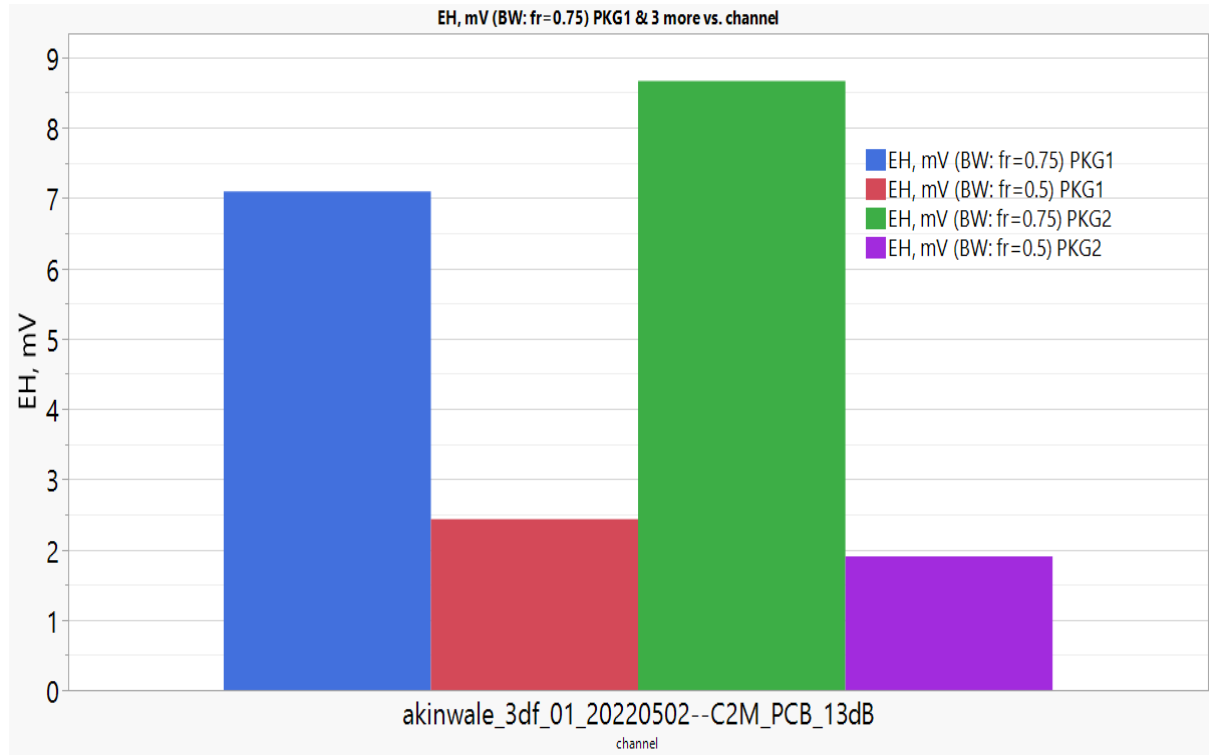

Summary

- ❑ A raised cosine reference receive filter can improve 200 G performance
 - Compared to the Butterworth filter used in COM computations
- ❑ More work may be needed to refine receiver filter parameters
 - Especially with more published channels.
- ❑ A raised cosine filter may alleviate measurement concerns
- ❑ Need to explore other issues resulting from specifying a raised cosine reference receive filter

Thank You!