

PoE Plus
IEEE 802.3at
Classification Ad Hoc
Extended Classification Using
Two Classification Events

Clay Stanford
Linear Technology
July 17, 2007
San Francisco



Problem Discovered in Protocol

- The proposed 2-Event Classification protocol has a problem:
 - Using a compliant Type 1 (802.3af) PSE
 - Using a compliant Type 2 (802.3at) PD
 - When a Type 2 PD is plugged into a Type 1 PSE, possible for PD to incorrectly interpret waveform as the 2-Event Classification mechanism

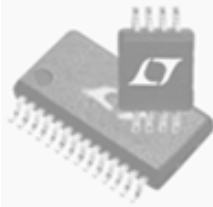

Details of Problem

- When a PSE is probing an open circuit, port voltage can go to 30V (Table 33-2, item 1)
- At the moment the Type 2 PD is connected to the cable, internal PD voltage can exhibit a spike similar to a classification pulse (refer to sample waveform)
- This spike can fool the PD state machine into thinking the first classification event has occurred
- After detection, Type 1 PSE may perform classification which would appear to Type 2 PD as the second classification event.
- Type 2 PD would incorrectly conclude that Type 2-Layer 1 PSE is present

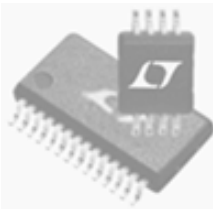

Graphical Depiction of Problem

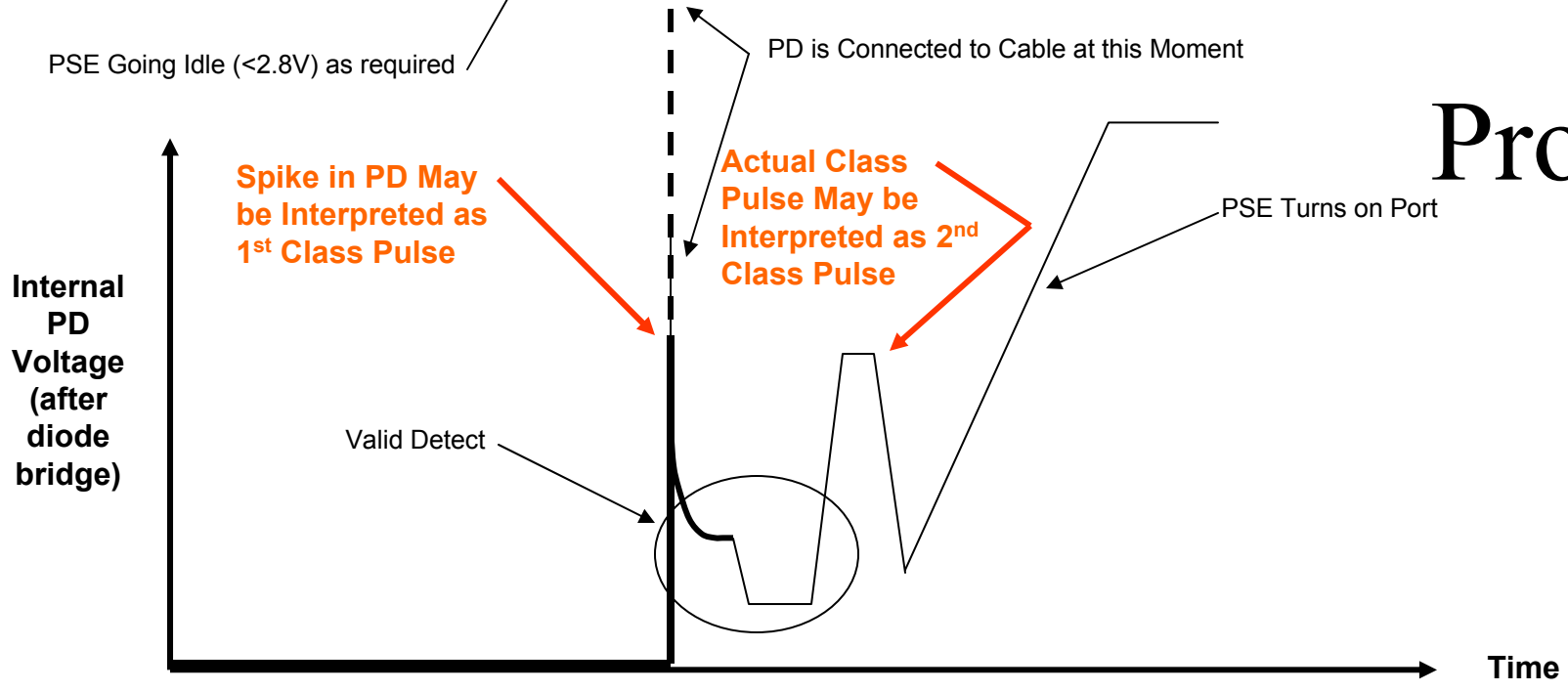
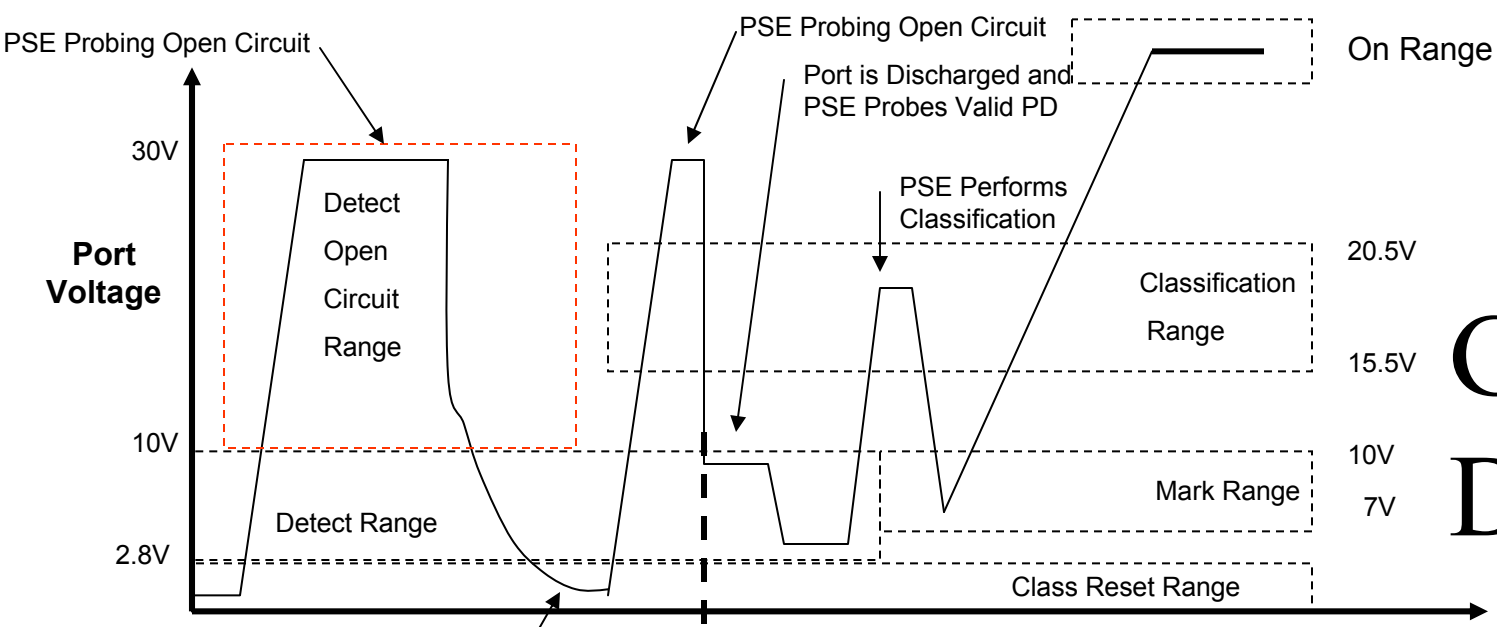

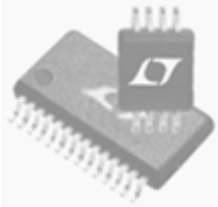

Worst-Case Open-Circuit Port Model

Switch closure represents PD being connected to the end of the cable

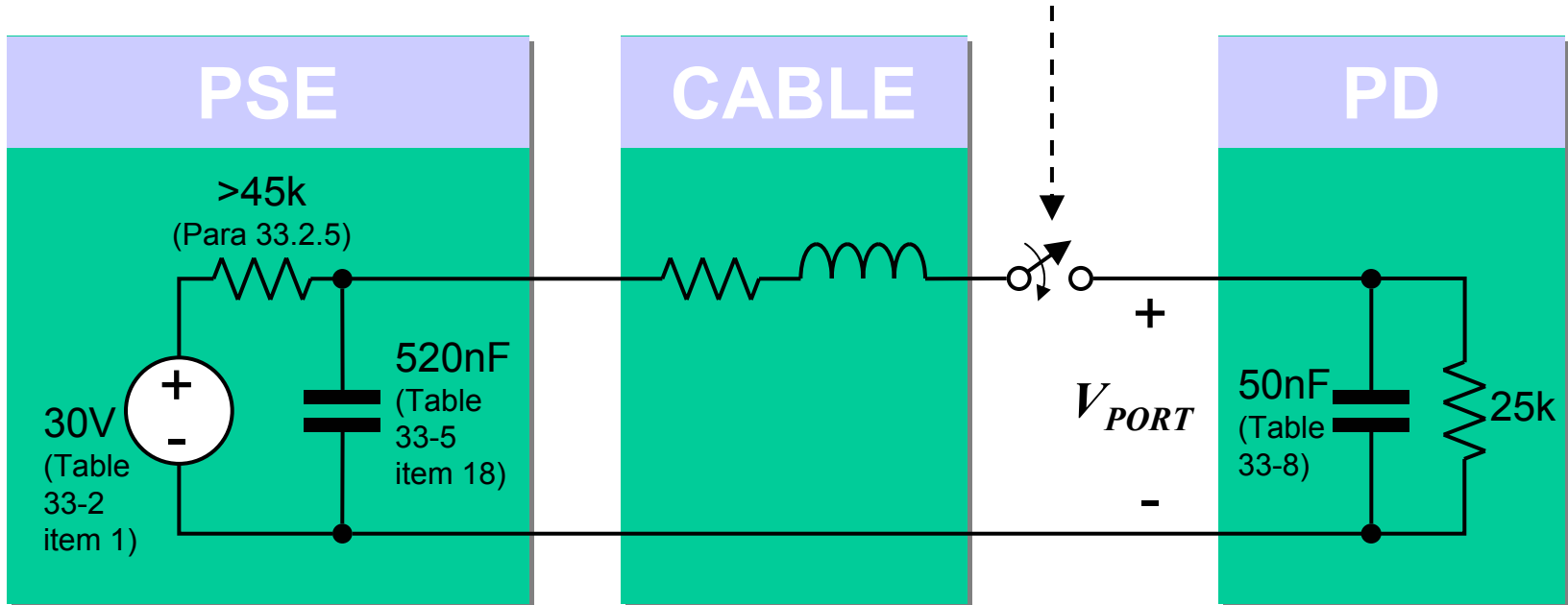

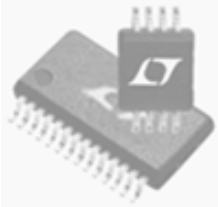

Experimental Waveform

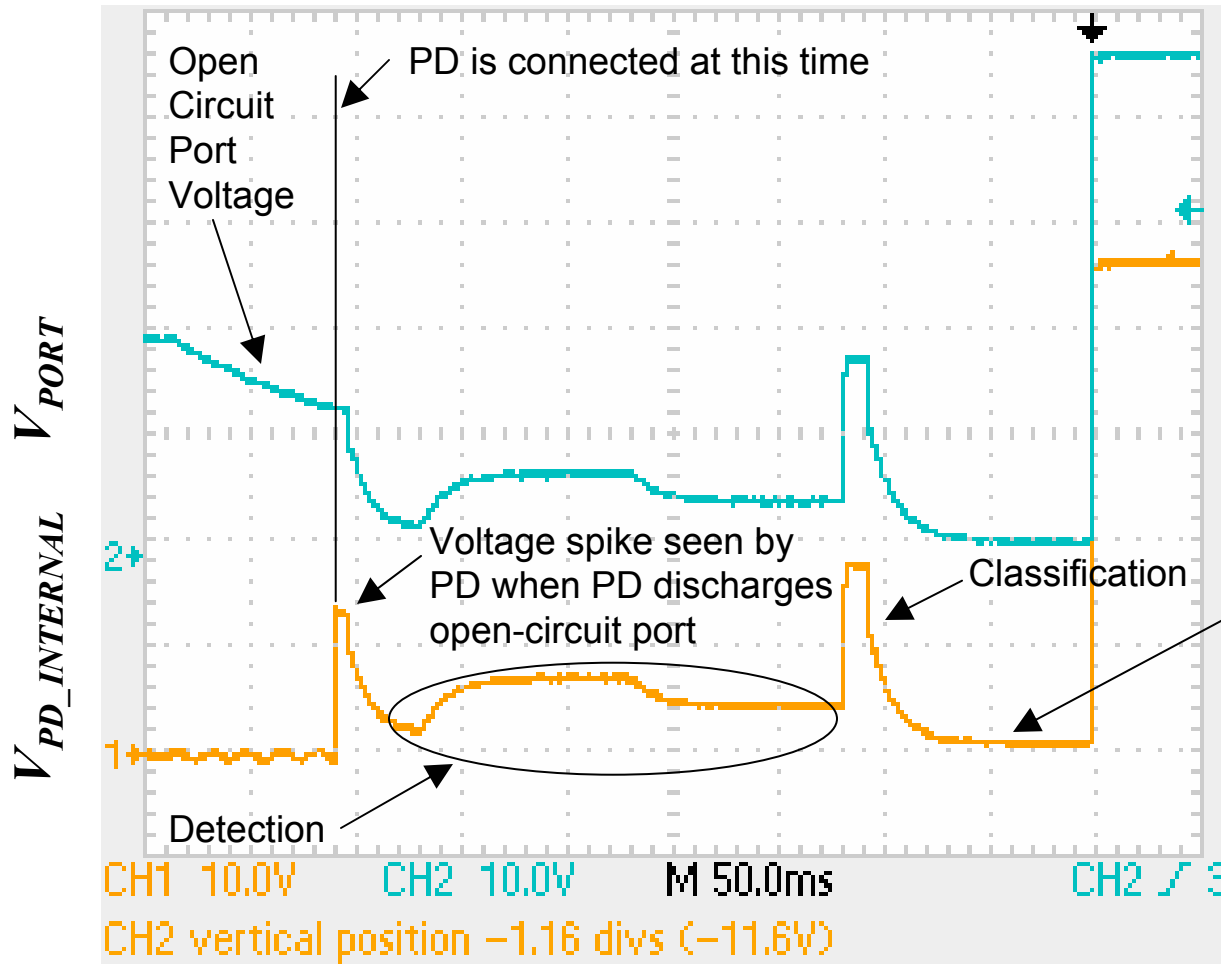

In this example, port goes to 0V which would reset the PD state machine. However, that is not required per IEEE 802.3af

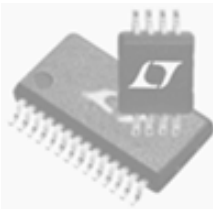

PD/PSE State Machines

Three Thresholds Associated with Method

- Reset Threshold: $2.8V \leq V_{THR} < 6.9V$
- Mark Threshold: $10V < V_{THM} < 14.5V$
- On Threshold: $30V < V_{on} < 42V$

Transition via Layer 2 if Type2Layer2 PSE present

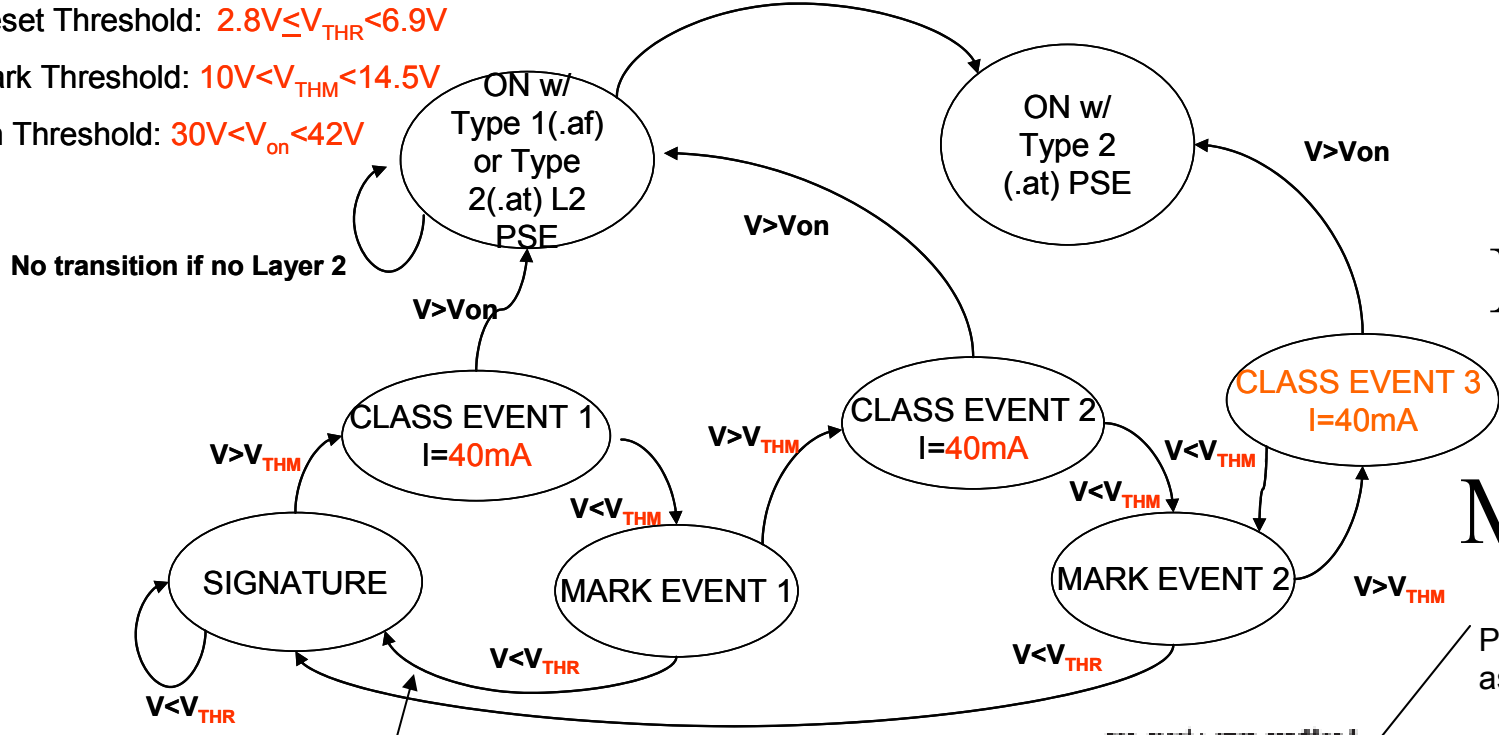

PSE Idle State is defined as $V_{port} < 2.8V$

PD State Machine Depends on PSE going to Idle State

When plugging in PD, possible to Enter PSE State Diagram Here

If PD Plugged in after Idle State and Before Detection Phase 1 is complete, PD can see spike and may not see Idle State (used for PD Reset).

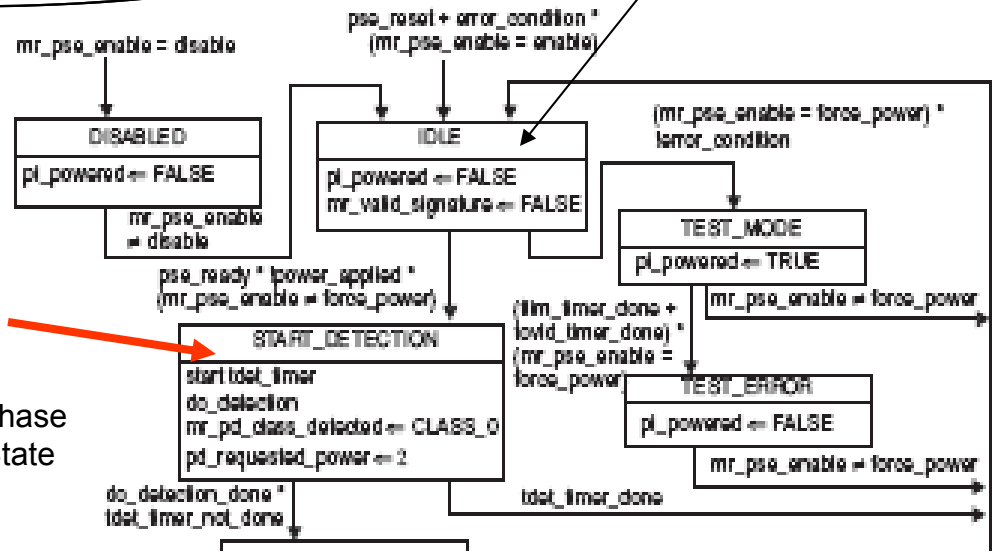

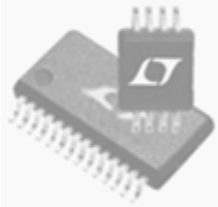

Solution

- Do Not Allow 25K During Mark
 - PSE would fail detection during Mark period
 - PSE would return to Idle State ($V_{port} < 2.8V$)
 - PD State engine would be reset
 - No false Identification

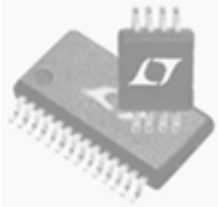

Revised Specificiaton

Mark Specification **IS:**

- PD current: $0.25\text{mA} < I_{\text{PD}} < 2.0 \text{ mA}$

Mark Specification **SHOULD BE:**

- PD current: $0.25\text{mA} < I_{\text{PD}} < 2.0 \text{ mA}$

AND

- PD 2-point signature:

$$R_{\text{PD}} < 15\text{kohm}$$

Note: Below Signature, 15K is the largest resistance that is to be rejected by the PSE. Resistances above 33K are disallowed because they might not draw enough current.

Motion to Implement Change

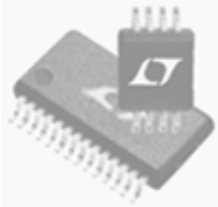

Motion by Clay Stanford
Seconded by XXXX

The 802.3at Task Force accepts page 9 of presentation stanford1.pdf presented July 18X, 2007 and instructs the editor to implement this change in the draft.

All in room:
For: XX
Against: XX
Abstain: XX

802.3 Voters Only:
For: XX
Against: XX
Abstain: XX

Revised Presentation of 2-Event Classification Mechanism

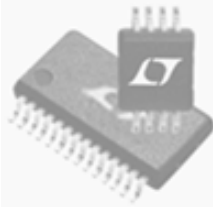

- The following slides are provided for reference and are identical to Geneva presentation except page 20 which provides new PD Mark requirements.

802.3at Classification Using Two Classification Events

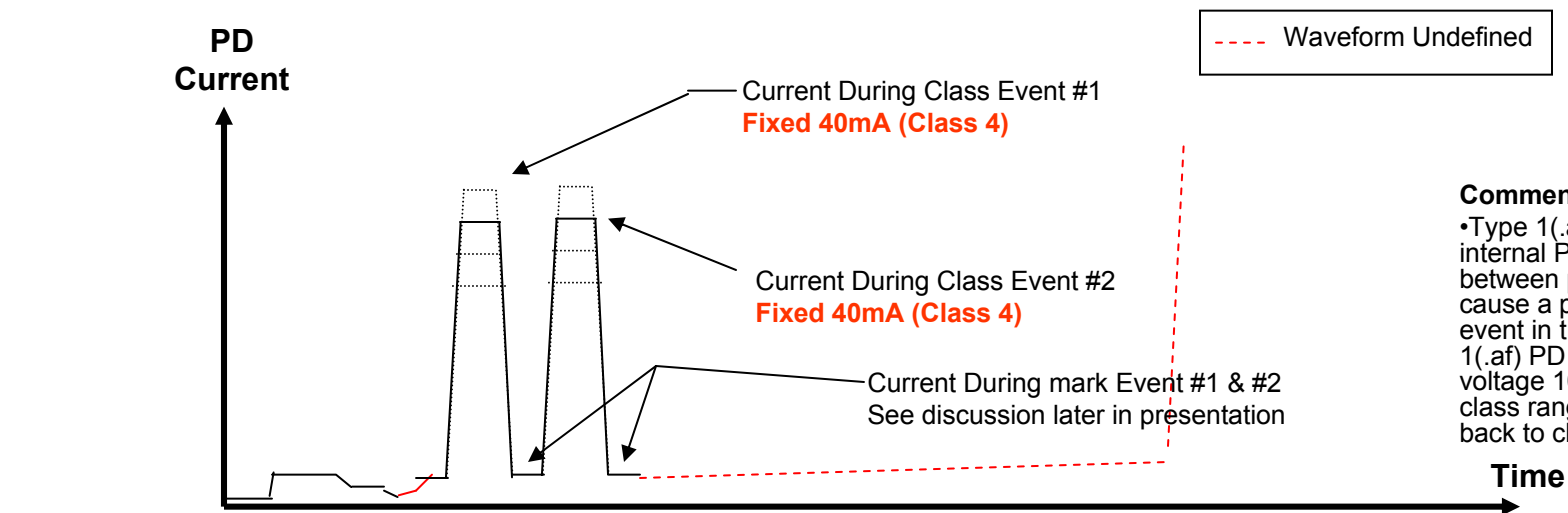
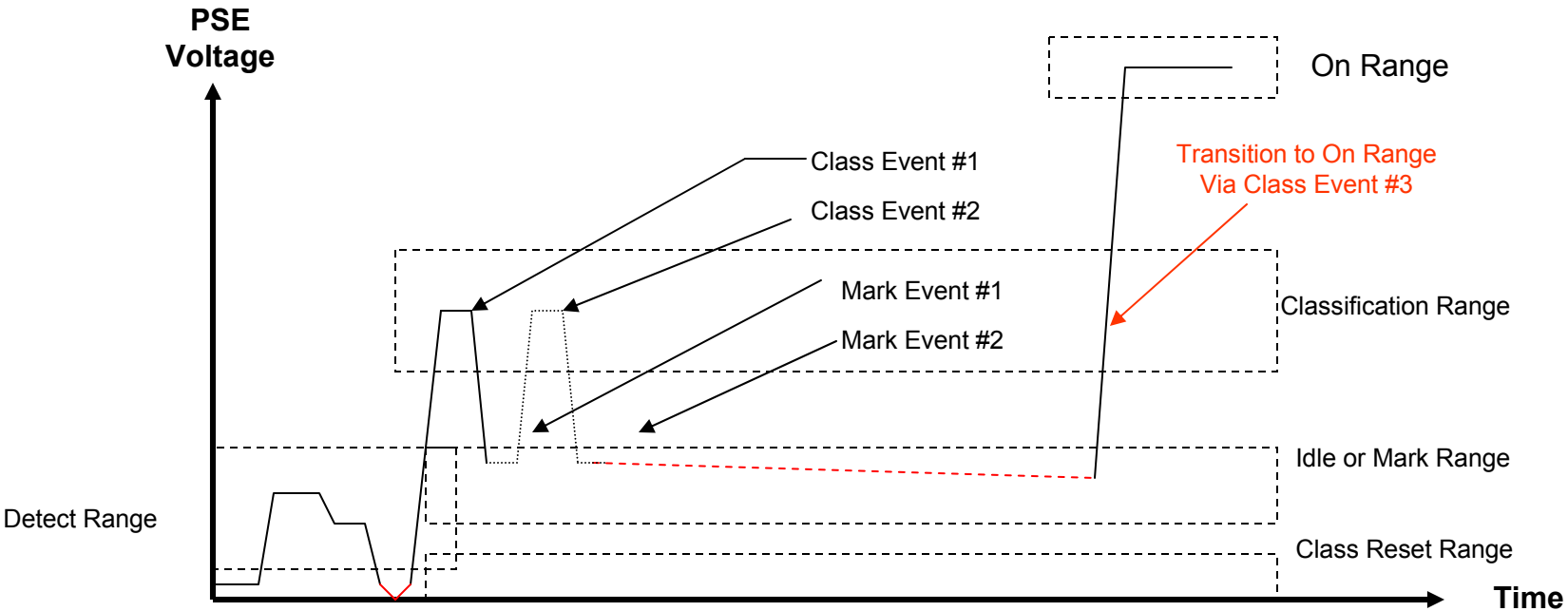
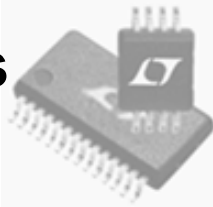

Comment

•Type 1(.af) PD may not pull internal PD supply down quickly between pulses but this doesn't cause a problem. With the Mark event in the Signature range, Type 1(.af) PD might "float" at some voltage 10-20V, but will return to class range when PSE drives port back to class voltage.

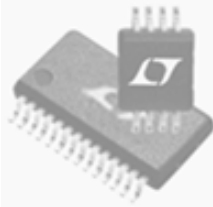

PoEP: IEEE 802.3at

Two Event Rules

Type 2 (.at) PD Rules:

- PD is behind diode bridge so fall time is controlled by internal PD circuits and not PSE port voltage. Therefore a Type 2 (.at) PD is required to pull the internal supply down using the classification event current until the PD detects the Mark event. Once the PD has detected the Mark, the PD can stop pulling down on the port. Note that in this scenario, the port voltage may not discharge all the way down to the Mark range and this is not a problem.
- If the port voltage goes to reset range, PD state engine is reset and the PD will go to the detect state.

Type 2 (.at) System Rules:

- Type 2 (.at) PSE is the master, generating port voltage. Type 2 (.at) PD is slaved to Type 2 (.at) PSE , responding with port current.
- System is designed so that Type 2 (.at) PD spends a limited amount of time in the Mark range in case Type 2 (.at) PD is using dynamic memory which requires power to maintain state.
- Type 2 (.at) PSE must transition from 2nd event through Class Event 3 to Power On without going down into Reset range.

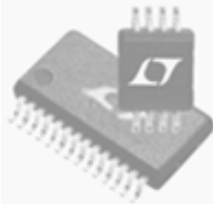

PoEP: IEEE 802.3at

Two-Event Type 1/2 (.af/.at) Interaction

Type 2 (.at) PSE with Type 1 (.af) PD:

- If a Type 2(.at) PSE sees class 0, 1, 2, or 3, it assumes Type 1(.af) PD and powers per .af spec, i.e. 15.4W, 4W, 7W, 15.4W respectively.
 - Note: Type 1(.af) PD that uses class 4 (in error) will get powered with 30W by a Type 2(.at) PSE. This is a minor annoyance with this class scheme and is considered acceptable.
 - If a Type 2(.at) PSE sees class 4, and it is using layer 1 only for classification, it must ping twice.
 - If a Type 2(.at) PSE sees class 0,1,2, or 3, it has the option of pinging either one or two times.

May06 motion to include 2W class and July06 motion for ~9W class will not be supported.

Type 2(.at) PSE with Type 2(.at) PD:

- Type 2(.at) PSEs should see class 4 when connected to a Type 2(.at) PD.
- Type2(.at) PSE only using L1 will ping twice to signal to the Type 2(.at) PD that it is a Type 2 PSE.
- If a Type 2(.at) PSE sees inconsistent class results (i.e. 4-1, 4-2, etc), the behavior is non-compliant and PSE action is undefined.

.Type 1 (.af) PSE with Type 2 (.at) PD:

- If a Type 1(.af) PSE sees a Type 2 (.at) PD, it will see class 4 and power at 15.4W.

Motion from March 2006



The IEEE 802.3at Task Force affirms that a PD requiring more than 12.95W will support a Layer-1 Classification extension and a Layer-2 Classification mechanism.

Endpoint PSEs must support Layer-2 classification or Layer-1 classification extension for PDs requiring more than 12.95W.

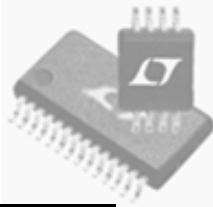

All Possible PSE/PD Combinations

PSE TYPE	PD TYPE	COMMENTS
Type 1(.af)	Type 1(.af)	Existing 802.3af system, class 0, 1, 2, or 3.
Type 1(.af)	Type 2(.at)	Type 1(.af)PSE sees class 4 and powers per 802.3af specification, i.e. 15.4W. Type 2(.at) PD can only assume Type 1 PSE and must operate with 15.4W and alert user not enough power.
Type 2(.at) L1 i.e. high power midspan	Type 1(.af)	Type 2(.at) PSE sees class 0, 1, 2, 3 and powers per 802.3af specification.
Type 2(.at) L1 i.e. high power midspan	Type 2(.at)	Type 2(.at) PSE sees class 4 and powers with maximum allowable 802.3at power level. Type 2(.at) PD sees two class pings and knows Type 2 PSE connected. Power information is known before PD is powered.
Type 2(.at) L2 i.e. end point PSE	Type 1(.af)	Type 2(.at) PSE sees class 0, 1, 2, 3 and powers per 802.3af specification. Layer 2 communication fails to establish. Power level is maintained at .af levels. PD sees af behavior and operates under .af specs.
Type 2(.at) L2 i.e. end point PSE	Type 2(.at)	Type 2(.at) PSE sees class 4 and powers with 15.4W. Layer 2 communication is established and mutual identification is established. High power operation begins.

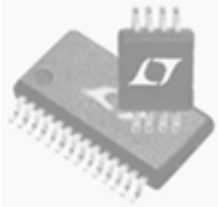

Voltage Ranges and Timing Specification

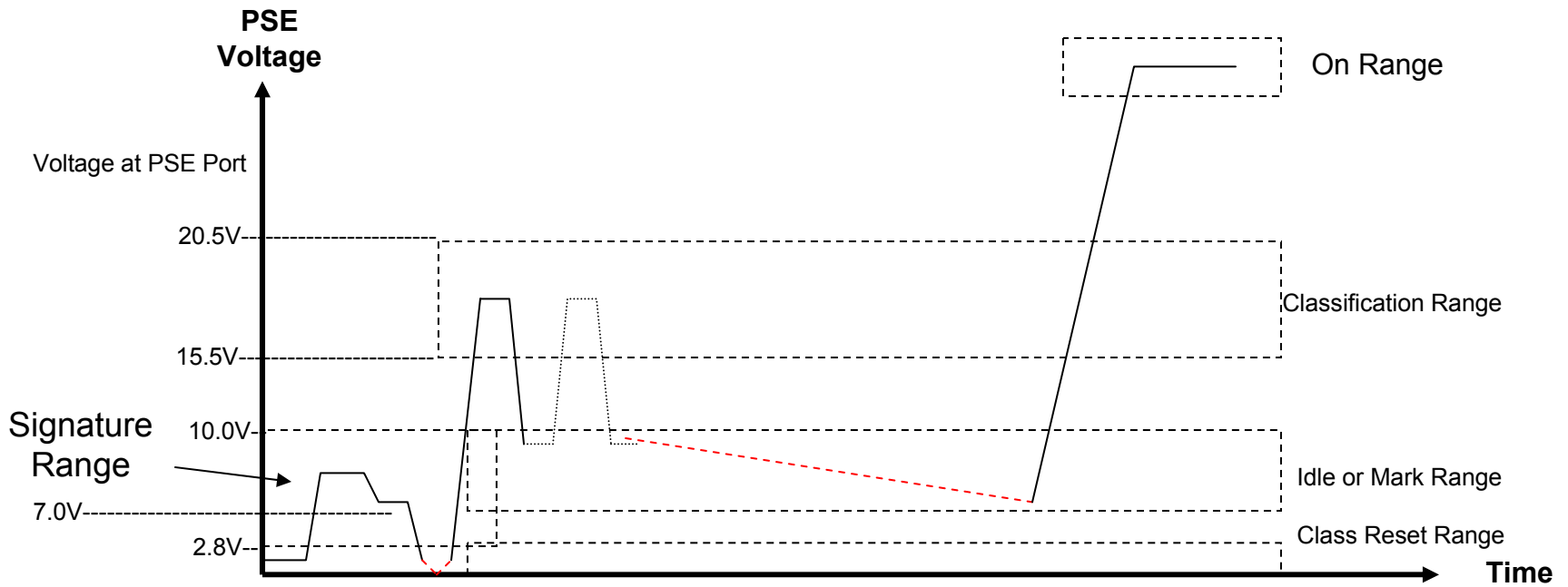



PSE and PD Voltage Ranges

PSE VOLTAGE SPECIFICATIONS		
FUNCTION	MIN (V)	MAX(V)
Classification	15.5 ¹	20.5 ¹
Mark	7.0	10
Low Reset Range	0	2.8 ¹
High Reset Range	--	--

PD VOLTAGE SPECIFICATIONS		
FUNCTION	MIN (V)	MAX(V)
Classification	14.5 ¹	20.5 ¹
Mark	6.9 ²	10 ³
Low Reset Range	0	2.8 ³
High Reset Range	30 ^{1,4}	

Notes on Calculations

1. Value from 802.3af specification.
2. Assume cable max resistance = 20ohms so as to also work with .af systems.
Cable drop max = 2mA (mark current max) * 20ohms = .04V~0.1V.
With 7V at PSE, may only be ~6.9V at PD.
3. PD Mark and Reset limits are not equivalent to PD signature range (2.7V-10.1V). PD upper limits are equal to PSE upper limits.
4. Reset high occurs when powered PD drops below PD power supply turn off voltage.

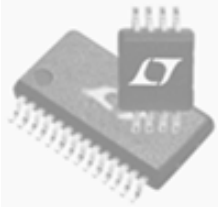

Timing Specification

TIMING SPECIFICATIONS		
EVENT	MIN (ms)	MAX (ms)
1 st Class	6	30
1 st Mark	6	12
2 nd Class	6	30
2 nd Mark	6	12
TOTAL (for reference only)	24ms	84ms

Note 1. Time from end of detection until power on is limited by section 33.2.8.13.

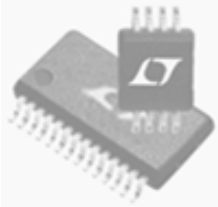

Classification State Engine in PD

Three Thresholds Associated with Method

- Reset Threshold: $2.8V \leq V_{THR} < 6.9V$
- Mark Threshold: $10V < V_{THM} < 14.5V$
- On Threshold: $30V < V_{on} < 42V$

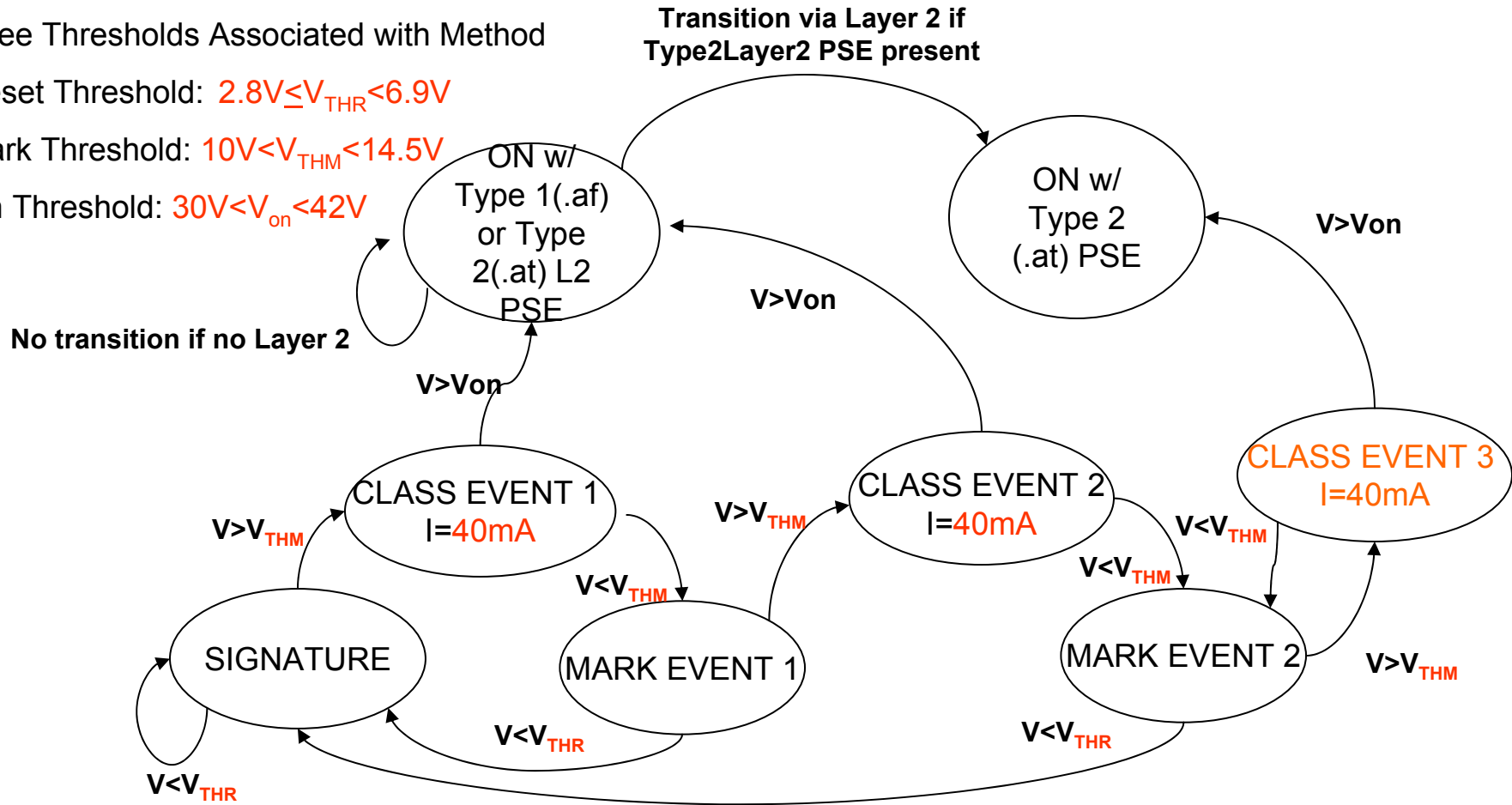

Class Event 3 exists to create a defined behavior for Type 2(.at) PDs when pinged repeatedly. This allows future expansion of the classification mechanism with a known response from Type 2(.at) PDs. PD transitions through Class Event 3 during power on.

PD Behavior During Mark Event

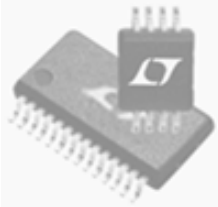

Mark Specification:

PD current: $0.25\text{mA} < I_{PD} < 2.0 \text{ mA}$

AND

PD 2-point signature:

$R_{PD} < 15\text{Kohm}$

REVISED 7-17-07

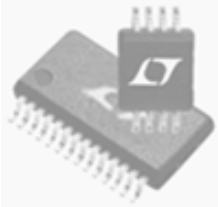

PD Current

With Type 2 PDs, the current is a function of the state of the PD*:

- Type 2 PDs will draw Class 4 current when in the Class state. The port voltage while in the Class state can range from 20.5V down to near 10V, depending on implementation.
- Type 2 PDs will draw 0.25-2mA when in the Mark state. The port voltage while in the Mark state can range from 7V up to near 15.5V, depending on implementation.

*The state of the PD transitions based on port voltage.

Existing 802.3af PSE State Engine

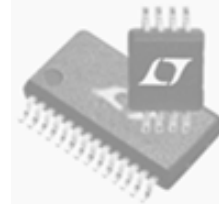

Expansion of Classification Function

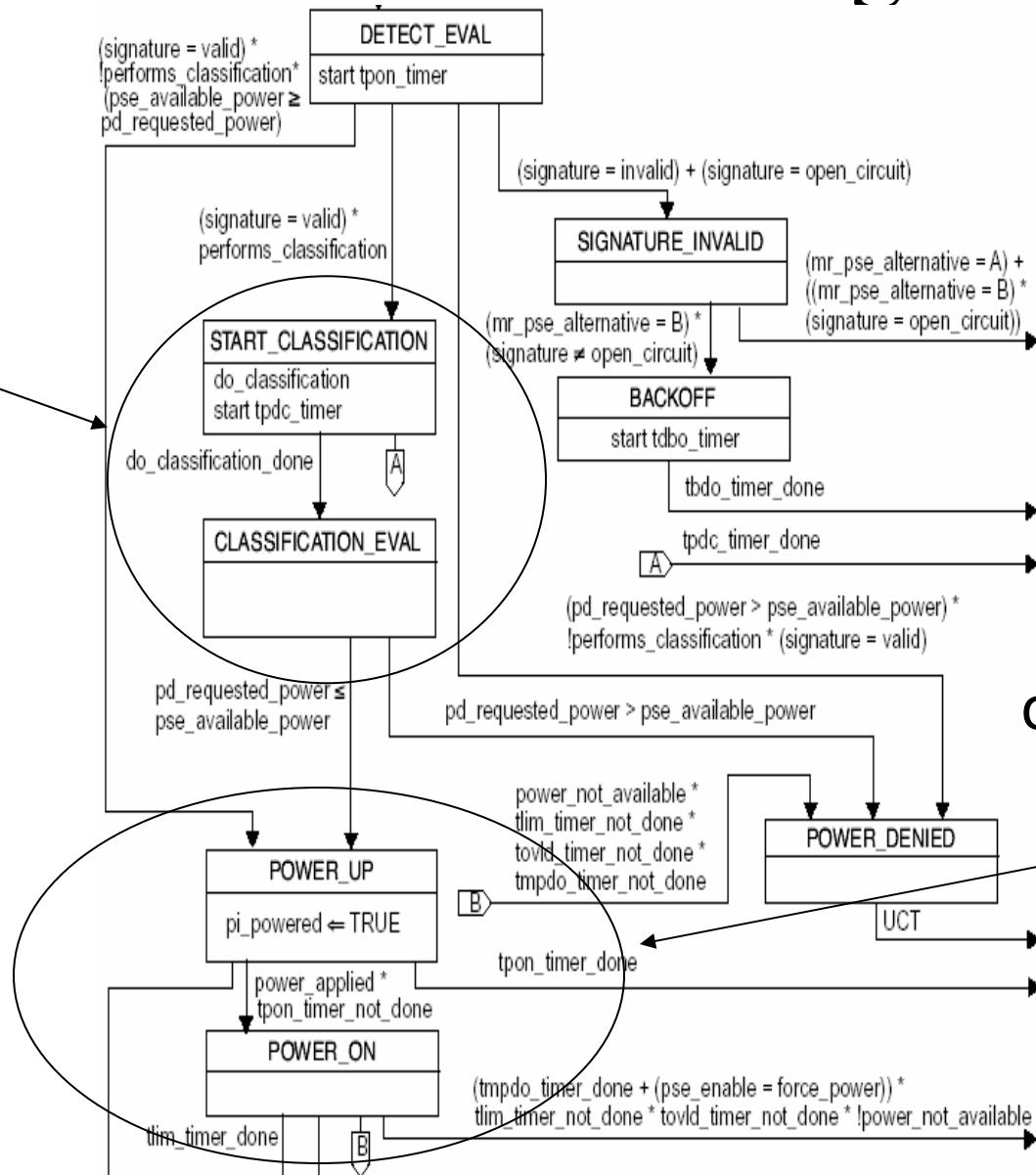

Expansion of Power On Function

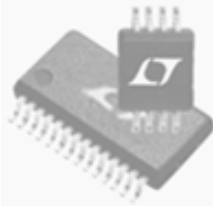

Expanded PSE Classification State Engine

Preliminary!

???Do we plan to have a single state diagram for .af PSEs and .at PSEs, or will there be two different diagrams? Same question for Type2_Layer1 and Type2_layer2 PSEs. I think 3 separate diagrams would be more clear.

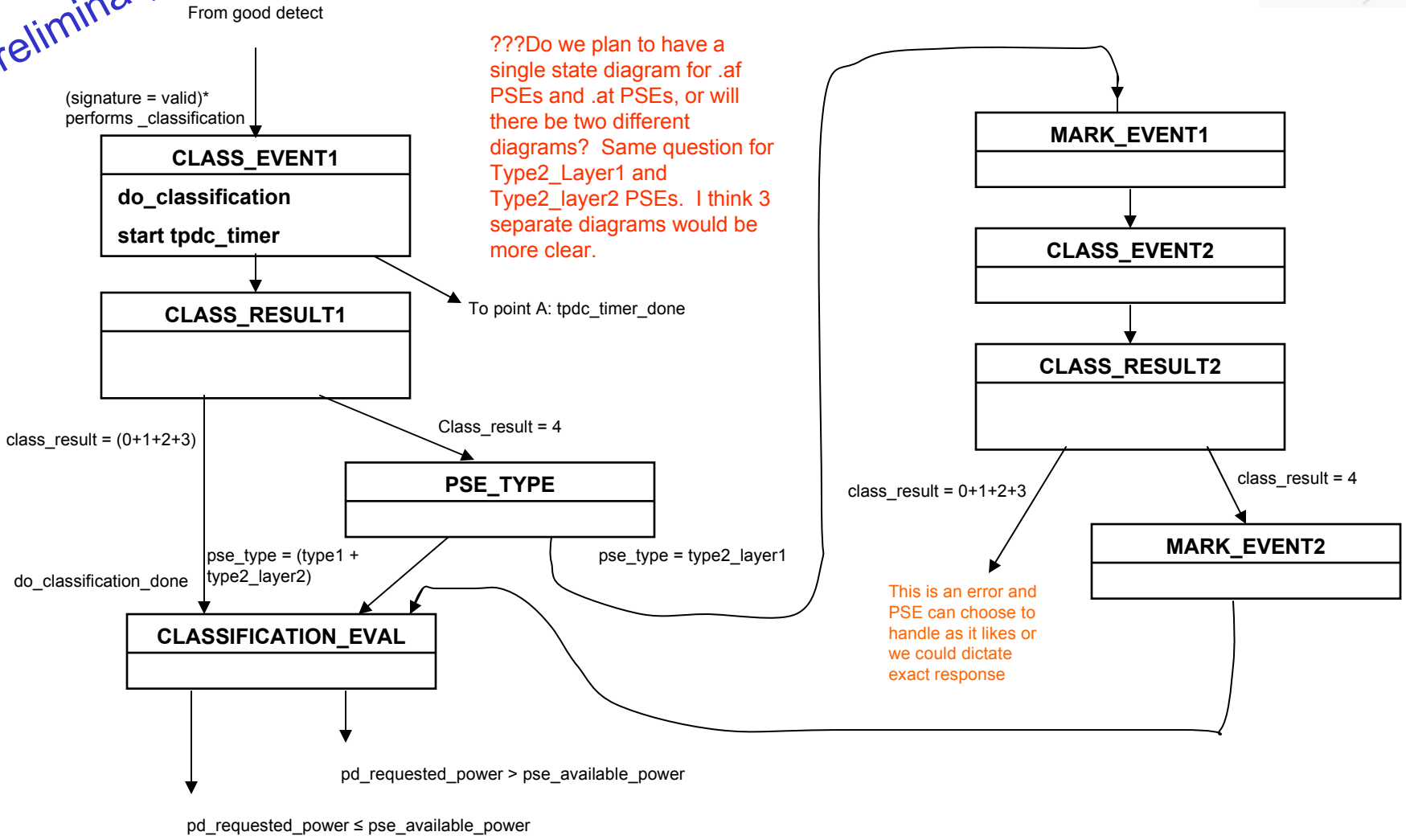

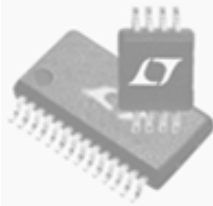

Expanded PSE Power-On State Engine

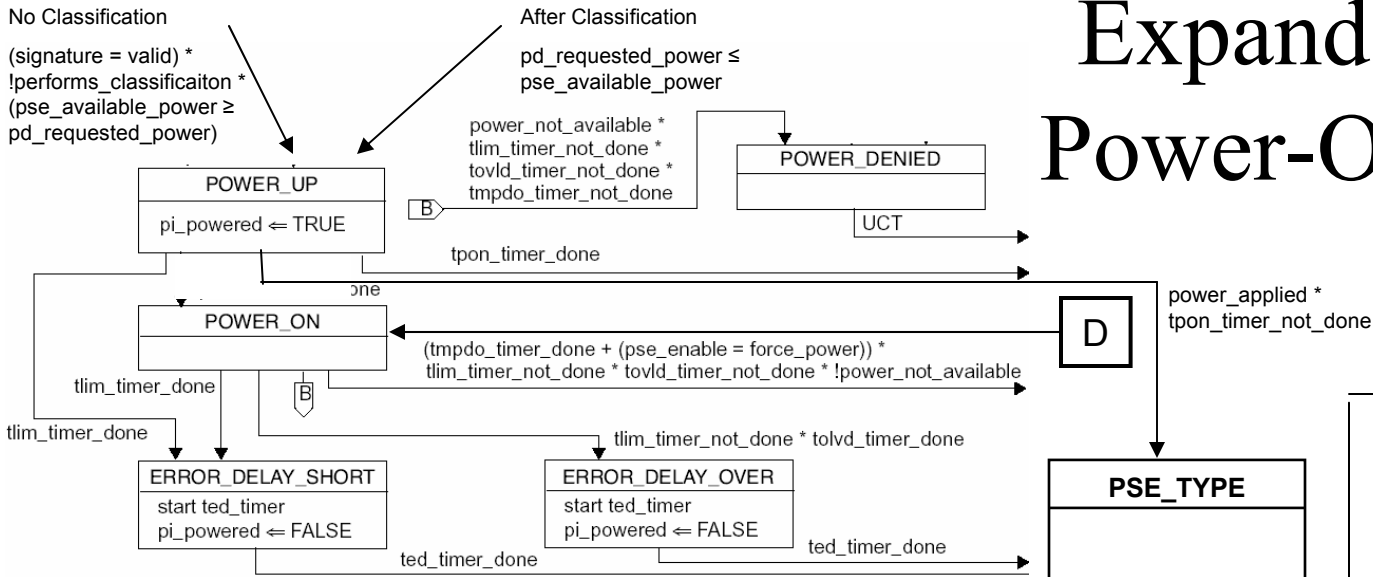

We need to define some new timing parameters. I would propose:

$t_{PSE_HIGH_PWR_DELAY} = 100ms \text{ max}$

Defined from point $V_{port} \geq 50V$ until Current Limit is switched from type 1 (.af) to type 2 (.at) mode

Determines the time between finish of inrush until PSE port is switched from type 1 (.af=425mA) to type 2 (.at == 780mA). It should be pretty fast, in case PD starts drawing big power soon after it receives voltage.

$t_{PD_HIGH_PWR_DELAY} = 100ms \text{ min}$

Defined from point $V_{port} \geq 41V$ until PD draws > 12.95W

Forces PD to wait some period of time before using big power so PSE has time to switch from .af to .at mode.

$t_{PSE_COMM_PERIOD} = 5sec \text{ min}$

Defined from point $V_{port} \geq 50V$ until PSE gives up establishing communication with layer 2 PD. After this point, PSE assumes PD is type 1 PD. Needs to be long enough to give PD time to boot up and establish communication.

$t_{PD_COMM_BOOTUP} = 4sec \text{ max}$

Defined from point $V_{port} \geq 41V$ until PD must be ready to communicate with PSE on layer 2. We need input from system vendors on this!

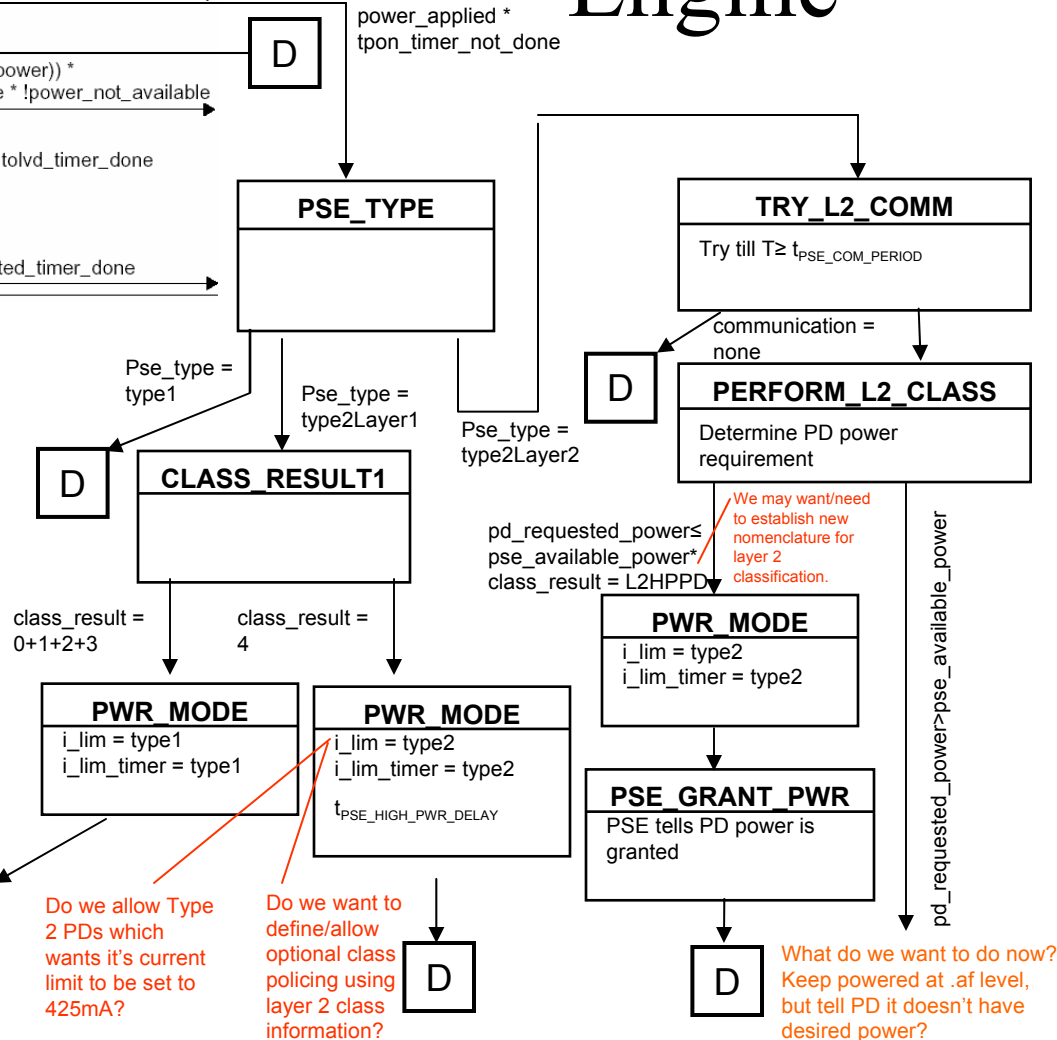

Addendum

Supporting Material



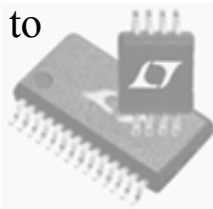

$$dt_{max} = (C/I) dv$$

$$= (.66\mu F / 36mA) (20.5-10)$$

$$= 0.19ms \text{ max i.e. OK}$$

Discharge of port from Class state to Mark state must occur within the Mark minimum time (6ms).

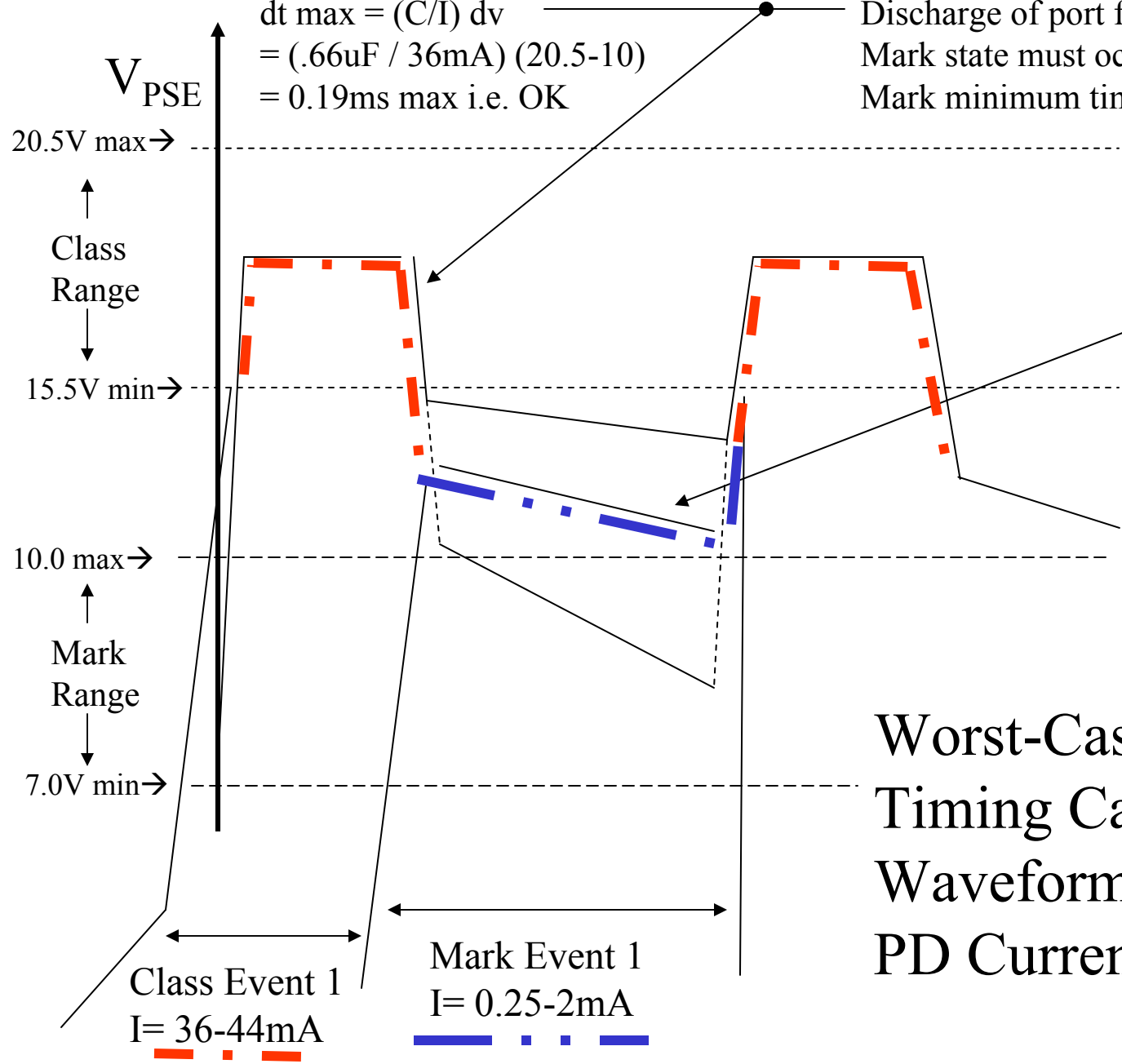

When the PD detects the Mark event, PD changes to Mark state. PD current is reduced and further port discharge is at a slower rate. The port is not required and may not discharge into the Mark range. Any of the depicted waveforms may occur and are acceptable.

Worst-Case Discharge Timing Calculations Waveform Clarification PD Current Clarification